



### Table of Contents

#### Introduction

Terms and Conditions	2
General Specifications	7
Materials & Finish Palette	9

#### Highline Conference Tables

Table Specifications	16
42"/48" Rectangular Conference Tables	22
54" Rectangular Conference Tables	28
60" Rectangular Conference Tables	34
72" Rectangular Conference Tables	40
Elliptical Conference Tables	46
Boat Conference Tables	52
Trapezoid Conference Tables	58

#### Highline Meeting Tables

Table Specifications	64
Meeting Tables	68

#### Highline Credenzas

Credenza Specifications	74
Credenzas	80

#### Highline Fifty Conference Tables

Table Specifications	88
48" Rectangular Conference Tables	94
54" Rectangular Conference Tables	100
60" Rectangular Conference Tables	106
72" Rectangular Conference Tables	112
48"-72" Boat Conference Tables	118

#### Highline Fifty Meeting Tables

Table Specifications	126
Meeting Tables	132

#### Highline Fifty Credenzas

Credenza Specifications	138
Credenzas	144

#### Highline Twenty-Five Credenzas

Credenza Specifications	150
Credenzas	156

#### Highline Vector Conference Tables

Table Specifications	162
42", 48" & 54" Conference Tables	166
60" Conference Tables	192
72" Conference Tables	202

#### Accessories

Power & Connectivity	213
----------------------	-----

# Terms and Conditions of Sale

---

Sales by DatesWeiser (hereinafter called the Seller) are made only on the terms and conditions set forth below. These terms and conditions may be modified or supplemented only by a written document signed by an authorized representative of the Seller. These terms and conditions supersede any prior and/or contemporaneous agreements or correspondence between Purchaser and Seller.

## Application of Standard Terms

Only the standard terms of sale stated in this catalog apply to any transaction unless those terms are modified or supplemented by a written document signed by an officer of DatesWeiser. Any terms contained in Customer's purchase order, including standard printed provisions, that are additional to or contrary to these terms, are not effective.

## Use of Furniture and Materials

DatesWeiser assumes that textiles, leathers and products are intended for commercial use and are not being bought for use primarily for personal, family, or household purposes. When installed and used as intended, products remain chattel property, are not considered fixtures, and no interest in them should arise under applicable real estate law.

## Pricing Policies

All written quotations expire thirty (30) days from the date of issuance and can be withdrawn by written notice anytime during that period.

Shipping, packaging, inside delivery, uncrating, installation, storage, and sales tax (if applicable) shall be in addition to the list price and shall be itemized and charged separately.

List prices are subject to change without notice.

List prices shall be those prices in effect on the date the Seller receives a completed Purchase Order unless shipment is requested more than 120 days after the order entry, in which case prices in effect on the date of shipment apply.

## Ordering Information

All orders must be in writing.

A Purchase Order is binding upon Seller's Order Acknowledgement. All dealers may submit their orders via email at [customerservice@datesweiser.com](mailto:customerservice@datesweiser.com). For assistance with this process, please contact DatesWeiser Customer Service at 716.891.1700 or [customerservice@datesweiser.com](mailto:customerservice@datesweiser.com)

## Taxes

All sales, use, excise, and other taxes applicable to the sale of DatesWeiser Products shall be paid by the Purchaser. To claim an exemption from any tax, Purchaser must submit to Seller the appropriate exemption certificates.

## Terms of Payment

A fifty percent (50%) deposit is due at the time of order placement and the remainder due within thirty (30) days of the date of invoice.

If, in the judgment of Seller, Purchaser's financial condition does not justify the terms of the payment, Seller may require full or partial payment in advance.

The ship date the Seller specifies is considered the invoice date for billing. The ship date will be confirmed by the Seller via a separate Acknowledgement issued upon receipt of a signed Purchase Order.

Past due accounts shall be charged one and one-half percent (1.5%) per month, or the highest rate permitted by law, whichever is less, and will be added to the outstanding balance. In the event Purchaser defaults on payment, Purchaser shall be liable for all collection costs, including reasonable attorney's fees and costs.

## Delays

Datesweiser is not liable for failure to ship by the acknowledged shipping date or any other date. Datesweiser is not liable for a delay or failure in shipment or performance if the delay or failure is caused by acts of omission of Customer, its agents, employees, contractors, a governmental authority, or God; delays in transportation; or other similar causes that are not within Datesweiser's reasonable control. Datesweiser is excused from further performance of its obligations for the duration of a force majeure cause.

## Changes and Cancellations

A confirmed order may not be changed or cancelled, in whole or in part, without prior written consent of Seller. Changes may effect delivery dates. Expenses incurred because of changes shall be charged to Purchaser. In event of cancellations, Purchaser will be liable for reasonable cancellation charges, including a \$500 administrative fee.

Seller is not required to comply with Purchaser's request to change a confirmed order, but all reasonable requests to change confirmed orders will be honored. Orders for special or custom Product may not be cancelled.

---

To be effective, a Change Order must be in writing, signed by the Purchaser or Purchaser's agent, and confirmed in writing by the Seller. Change Orders are subject to a charge for materials, labor, and other costs as determined by Seller.

**Security Interest**

Until Seller receives the full payment for the Product, Seller shall have a security interest in the Product. Purchaser agrees to perform all acts, including but not limited to the execution and filing of documentation, which may be necessary to perfect and assure the security interest of Seller.

**Freight and Delivery**

For product orders shipped within the 48 contiguous United States, surface freight charges are included. Orders are shipped via ground carrier unless requested otherwise.

For orders shipped to Alaska or Hawaii, the freight terms stated above apply only to the port of embarkation. Shipments beyond that point are freight collect. Domestic deliveries are shipped FOB DatesWeiser's plant to a destination designated by Customer by a method DatesWeiser selects.

Products are carefully inspected and packaged before leaving the factory to ensure they reach their destination in excellent condition. Whenever possible, the Seller will ship in accordance with the Purchaser's instructions. If Purchaser does not specify shipping instructions, Seller will use its best judgment to determine the most suitable shipping method, route, and carrier.

**Storage**

If the Purchaser cannot accept delivery per the ship date specified in the Seller's Acknowledgement, the Seller may transfer the merchandise to storage, either at its facility or at another facility.

Purchaser will be charged a storage fee of two percent (2%) of the invoice for every thirty (30) days the products are stored at the Seller's facility.

For products stored in another facility, all out-of-pocket costs of storage, including transportation and warehousing fees, will be at the Purchaser's expense.

The Purchaser will be invoiced for all product charges on the date the Products are transferred to storage. Storage fees will accrue monthly in full month increments (they are not pro-rated for partial months) and will be added to the first invoice, which will also include non-product charges such as shipping, installation, etc.

**Returns**

Purchasers may not return Products without Seller's written approval and shipping instructions. Unauthorized returns, and returns shipped inconsistently with Seller's instructions, will be automatically refused by the Seller's receiving department.

Products not currently offered for sale by Seller, including special and custom Products, shall not be authorized for return. All returned Products must be unused, in original condition and in original Seller shipping cartons. No refund or credit shall be given for damaged Products.

**Claims**

All shipments for Sellers Product are F.O.B. Origin. All risk of loss passes to Purchaser at time of delivery to carrier. Purchaser shall inspect all Products upon receipt and note any damage on the Bill of Lading and make an immediate request for inspection of damage by carrier. Seller is not responsible for damage that occurs in transit or storage.

Damage that becomes apparent after the Product is unpacked should be reported to the carrier and the Seller within twenty-four (24) hours of receipt. Damage that is incurred at a furniture dealer's warehouse is the responsibility of the furniture dealer.

For claims relating to Product damaged in transit, or for any other claims relating to or arising out of the transportation of the Product, Purchaser must seek recovery from the carrier. Seller may, upon request, assist Purchaser with filing of such claims with the carrier.

Claims for defects, errors, or shortages must be made in writing by Purchaser against Seller within 72 hours after delivery. Failure to make such claim within 72 hours shall constitute unconditional acceptance of the Products and a waiver of any apparent defects, errors, or shortages.

**Customer's Own Material (COM)**

A Purchaser who requests a material not standard to Seller's line of Products must submit a sample of the requested material to Seller prior to entry of a purchase order. Seller shall determine if the material is suitable to its manufacturing processes and meets any requirements of Underwriter Laboratories. If the COM is acceptable, Seller will then establish a price for using the COM on the Product in question.

---

### Custom Finish Match

For custom wood or paint finishes add \$1,000 net per finish. This is a one-time matching charge. Custom finishes may extend delivery time up to four (4) weeks. Control samples of custom finishes will be provided.

### Hardware

Final adjustment of furniture hardware such as hinges, drawer slides, drawer pulls, etc., at the installation and as a punch-list item, if required, is the Purchaser's responsibility.

### Design

All Products shown in the Seller's Price List and Specifications Guide are, and remain, the property of the Seller, who reserves the exclusive right to manufacture them. All dimensions shown are to be considered approximate. Seller reserves the right to make changes in price, dimensions, design and/or construction without prior notice.

### Shop Drawings

Seller allows for one (1) set of full shop drawings and one (1) round of minor drawing revisions in its pricing and scheduling. Thereafter, any significant changes in design, including dimensions, engineering details, and materials, or delays in reviewing and approving shop drawings, may necessitate additional charges and cause schedule delays. Seller reserves the right to determine the impact of any design changes and/or delays and will promptly notify those involved of any adjustments to cost and schedule.

### Field and Hold Dimensions

If a dealer or third party is responsible for providing installation, the following is required: Full responsibility for providing accurate and timely field dimensions or hold to dimensions (in cases where walls are not erected) as it effects the ultimate fit of the installation. As an alternative, upon request, Seller can provide a cost for sending a field technician to the project site to assume responsibility for field dimensions and site evaluation.

### Warranty

DatesWeiser International, Inc. ("DatesWeiser"), 6095 Fulton Industrial Blvd., SW, Atlanta, GA 30336-2806, USA, warrants the products sold by it to be free from defects in material and workmanship, regardless of the number of shifts during which the products are used, for the warranty periods specified below.

This warranty covers the sale of DatesWeiser product in all countries. Not all of the product lines appearing on this list are marketed by DatesWeiser in all countries, and appearance on this list does not imply an offer for sale of a product line in a particular place. Product line availability is defined in current price lists applicable to different regions.

DatesWeiser Commercial Office Furniture Products 12 years

All products sold under the DatesWeiser® brand name, except as limited or described below.

Textiles and Leathers

3 years

Includes, but is not limited to Edelman Leather, DatesWeiser, Herman Miller, Maharam, and Place fabrics.

Nonstandard Products

1 to 5 years

Warranty length on nonstandard products not covered by the 12-year warranty is identified on individual product quotes.

All Other Products, Parts, and Services

2 years

Height adjustable bases (electrical parts)

5 years

Height adjustable bases (mechanical parts) LED light strips and driver

3 years

All service parts

6 months

All other products, parts, and any services not listed above, sold or furnished by DatesWeiser, except for consumable products such as light bulbs and other electronic products for which no warranty is given

Other Manufacturers' Products

None



---

DatesWeiser will pass through to the original purchaser any warranty supplied by other manufacturers to the extent possible, including, but not limited to, open-line laminates.

Provisions that apply to all products and services:

During the applicable warranty period, DatesWeiser, as its sole obligation, will repair or replace (at its option) any product, part, or component covered by this warranty and sold after the effective date of this warranty, which fails under normal use as a result of a defect in material or workmanship; DatesWeiser will repair or replace the aforementioned product, part, or component with a comparable product, part, or component.

This warranty extends only to the original purchasers who acquire new product from DatesWeiser, or its authorized resellers. Any product, part, or component must have been installed, used, and maintained according to DatesWeiser's published instructions in order to be eligible for coverage under this warranty and must not have been subject to misuse or abuse. Any modification to the original product voids the warranty. DatesWeiser does not warrant the performance of the product when used in combination with other than original DatesWeiser product.

The warranty period starts from the date of purchase.

This document inclusively describes all of the warranties given and remedies available with respect to the company's products and services. DatesWeiser disclaims any other warranty whether express or implied, statutory or otherwise, in relation to the products.

DatesWeiser does not warrant:

- natural variations in wood grain or figure or the presence of character marks
- changes in surface finishes due to aging or exposure to light
- marks, scars, or wrinkles occurring naturally in leather
- veins, marks, voids, fissures, or cracks found naturally in stone

In addition, DatesWeiser does not warrant:

- failure resulting from normal wear and tear
- the matching of colors, grains, or textures of natural materials
- the colorfastness or the matching of colors of textiles, including an exact match to cuttings or to swatch cards

- damage, marking, or staining of veneer surfaces due to contact with rubber or similar compounds; damage from sharp objects or imprinting from writing instruments, or prolonged exposure to direct sunlight

DatesWeiser tests Customer's Own Material

(COM) and other customer-supplied items for manufacturing quality only and does not provide any warranty with regard to these materials.

DatesWeiser does not warrant products that are exposed to extreme environmental conditions or that have been subject to improper storage.

DatesWeiser's products meet the requirements of national and specific local codes as stated in the price books and other written publications.

TO THE EXTENT ALLOWED BY LAW, ANY IMPLIED WARRANTIES, INCLUDING ANY WARRANTY OF MERCHANTABILITY OR FITNESS FOR A PARTICULAR PURPOSE, ARE DISCLAIMED AND TO THE EXTENT THEY ARE LEGALLY REQUIRED, ARE LIMITED IN DURATION TO THE DURATION OF THIS WRITTEN WARRANTY.

DATESWEISER SHALL NOT BE LIABLE FOR LOSS OF TIME, INCONVENIENCE, COMMERCIAL LOSS, OR INCIDENTAL OR CONSEQUENTIAL DAMAGES.

Applies in US only: Some states do not allow limitations on how long an implied warranty lasts or do not allow the exclusion or limitation of incidental or consequential damages, so the limitations or exclusions in the two preceding paragraphs may not apply. This warranty gives the purchaser specific legal rights; however, the purchaser may also have other rights that may vary from state to state.

Applies outside US: Except as stated above, DatesWeiser will not be liable for any loss or damage (including costs) however caused, whether direct or consequential, incurred or suffered by the purchaser or any third party in respect of the products but nothing contained herein will or will be considered to exclude or restrict any liability on DatesWeiser's part for death or personal injury resulting from negligence.

---

**Disclaimers**

THE EXPRESS WARRANTIES CONTAINED IN THIS SELLING POLICY ARE THE ONLY WARRANTIES THAT DATESWEISER MAKES AND TAKE THE PLACE OF ALL OTHER WARRANTIES, EXPRESS OR IMPLIED, INCLUDING ANY WARRANTIES OF MERCHANTABILITY OR FITNESS FOR PARTICULAR PURPOSE AND ALL OTHER WARRANTIES ARISING FROM COURSE OF DEALING OR USAGE OF TRADE.

**Design Rights**

The designs depicted in DateWeiser's catalogs and price lists are proprietary to DatesWeiser and DatesWeiser reserves the exclusive right to manufacture them. Any reproduction of these designs infringes DatesWeiser's rights, and that infringement will be prosecuted.

Corporate Office / Factory

1700 Broadway Street

Buffalo, NY 14212

p 716.891.1700

# General Specifications

## Note:

Line drawings in this price list are purely for quick product identification without form of detail and cannot be used to satisfy production dimensions, shape or support options. Refer to Planning Guide for detailed product information.

## Levelers

All bases are equipped with floor levelers to level the table.

## Grommets

Please contact customer service at [customerservice@datesweiser.com](mailto:customerservice@datesweiser.com) or your local DatesWeiser representative to request a quote based on your specific needs. To find your local representative, visit

[www.datesweiser.com/contacts](http://www.datesweiser.com/contacts).

## Power & Connectivity

Refer to Accessories Section page 209.

## Wood Finishes and Materials

Selecting materials and other features are the first steps to ordering your DatesWeiser furniture. As you move through the steps on the product pages, you will need to fill in the blanks with the codes for the finishes and features you select.

Wood veneers are selected from the finest hardwoods available around the world and top coated with a low-VOC, post-catalyzed finish. The typical sheen is 30%.

Veneers come in two price ranges (Tiers), and described as follows:

1. Cut (Plain-sliced, rift, quartered, engineered)
2. Species (Oak, Walnut, etc.)
3. Finish (Natural, Smoked, Dark, Cerused, etc.)

Quartered, rift-cut and engineered veneers are slip matched except for Black Limba.

Plain-sliced veneers are book matched.

Examples:

1. T124 (Denotes Tier 1 Plain sliced Maple, Natural)
2. T227 (Denotes Tier 2 Quartered Walnut, Natural)

## Paint Finishes and Materials

SL\_\_ (Satin Lacquer)

Opaque paint with a 50% typical sheen.

HG\_\_ (High Gloss Polyester) Opaque paint with a hand rubbed high gloss finish.

\*Color codes are entered in the blanks.

## Metal Finishes and Materials

MC\_\_ Powder Coat

A coating applied electrostatically as a dry powder, then cured under heat to allow it to flow and form a 9skin9. Used to create a hard finish that is more durable than conventional paint.

PM\_\_ Premium Metal Electroplating produces a premium metal finish.

\*Color codes entered in the blanks.

## Finishing Excellence

DatesWeiser collaborates with leading colorists to develop a palette particularly suited to the executive workplace. This range is available on all our products and coordinates with our extensive veneer offering.

To order finish samples, please contact customer service at [customerservice@datesweiser.com](mailto:customerservice@datesweiser.com) or your local DatesWeiser representative. To find your local DatesWeiser representative, visit [www.datesweiser.com/contacts](http://www.datesweiser.com/contacts).

If you do not see what you want, we are happy to work with you to develop a unique product solution.

Datesweiser printed and veneer samples offer an example of what a typical veneer will look like, within a range of acceptability carefully determined by DatesWeiser. Samples and printed sample materials should be used as reference only.

## FSC® Certification:

### FSC®-C103565

Responsibility harvested materials certified by the Forest Stewardship® (FSC®-C103565) are available upon request and may increase pricing. Requests for FSC® (License: FSC®-C103565) certified materials or LEED certification must be made before an order is processed.

---

**Product Maintenance**

Regular dusting with a soft cloth will help prevent fine dust particles from becoming embedded in the finished surface. We recommend using a soft flannel cloth slightly dampened with water, followed by a dry cloth. Always wipe in the direction of the grain.

**CAUTION:**

Never use a chemically treated cleaning cloth.

For removing residues, smudges, etc., we recommend using a very mild (non-ammonia) soap and water solution. Apply with a soft flannel cloth followed by a dry cloth. Always wipe in the direction of the grain.

We recommend using felt pads on all objects that come into contact with our furniture. Certain vinyl and rubber products can chemically react with the finish on wood if left in contact for extended periods of time. Coasters, place mats, notebook covers, and rubber or plastic feet (found on most accessories) can also damage wood surfaces. To avoid indentations caused by writing instruments, always use a non-vinyl blotter or writing pad.

All furniture should be used in a stable, controlled atmosphere and positioned to avoid direct sunlight. The ideal climate is 65-75°F with 30-55% relative humidity.

# Materials & Finish Palette

**Veneer finishes come in (2) sheens:**

**M = 15% Sheen**

**L = 35% Sheen**

---

## Veneer: Tier 1 - Natural

---



**T001** White Quarter Cut Ash



**T002** Natural Flat Cut Oak

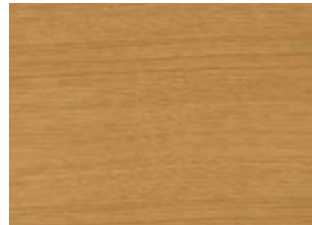

**T003** Natural Rift Cut Oak



**T004** Natural Flat Cut Walnut



**T005** Cashmere Flat Cut Walnut

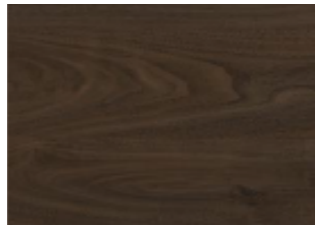

**T006** Persian Flat Cut Walnut

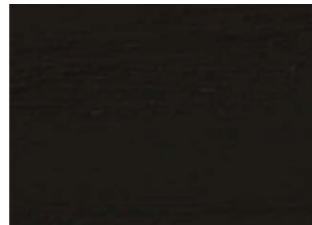

**T007** Ebonized Flat Cut Ash



**T014** Natural Flat Cut Maple



**T019** Natural Rift Cut European Oak

**Veneer finishes come in (2) sheens:**

**M = 15% Sheen**

**L = 35% Sheen**

Veneer: Tier 1 - Engineered



**R008** RecoGrain Natural Flat Cut Walnut



**R009** RecoGrain Natural Quarter Cut Walnut



**R010** RecoGrain Natural Quarter Cut Oak



**R011** RecoGrain Frosty Quarter Cut Ash



**R012** RecoGrain Natural Quarter Cut Rima Oak

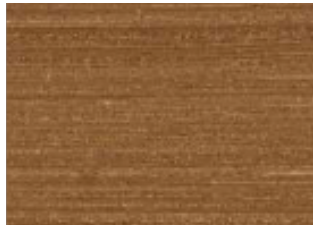

**R013** RecoGrain Natural Quarter Cut Rima Walnut



**GET** RecoGrain Clear on Ash \*



**GEU** RecoGrain Oak on Ash \*



**GEV** RecoGrain Walnut on Ash \*



**G637** Techwood Natural Oak \*



**G644** Techwood Light Walnut \*



**G645** Techwood Dove Grey Oak \*

\* Available in matte sheen as standard

Veneer: Tier 2 - Natural



**T015** Natural Quarter Cut Walnut

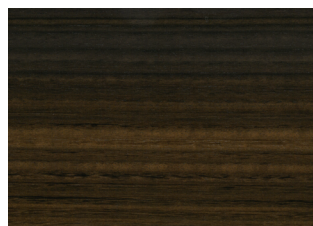

**T016** Fumed Quarter Cut Eucalyptus

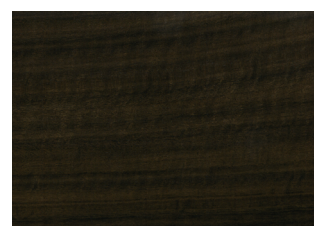

**T017** Fumed Quarter Cut Figured Eucalyptus

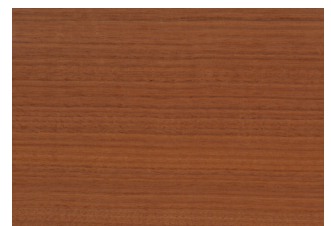

**T018** Natural Quarter Cut Makore

---

Paint: High Gloss Polyester + Satin Lacquer

---



**HG01 / SL01** White

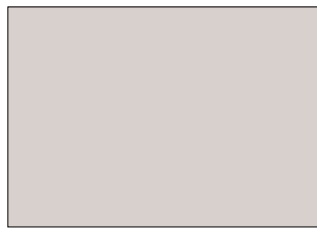

**HG02 / SL02** Light Beige



**HG03 / SL03** Sand



**HG04 / SL04** Taupe

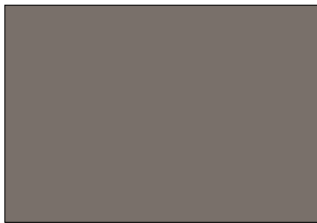

**HG05 / SL05** Light Brown



**HG06 / SL06** Light Grey

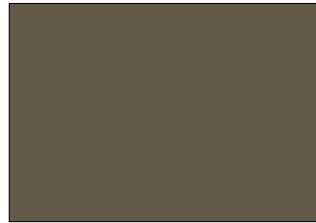

**HG07 / SL07** Quartz Grey



**HG08 / SL08** Umbra Grey



**HG09 / SL09** Black Brown

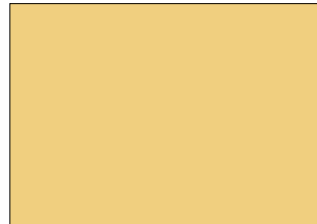

**HG10 / SL10** Yellow Finch

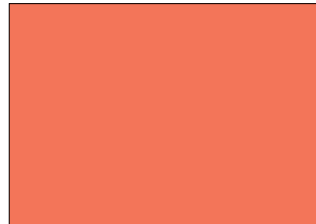

**HG11 / SL11** Jack O Lantern

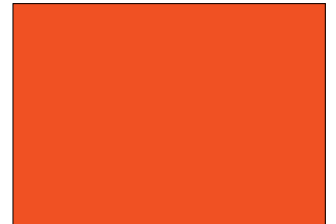

**HG12 / SL12** Racing Orange

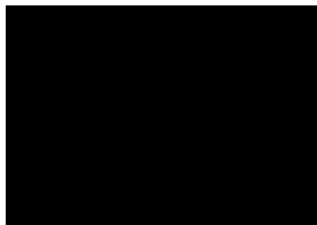

**HG13 / SL13** Jet Black



**HG20 / SL20** Red

---

## Metal: Powder Coat

---



**MC01** White



**MC02** Light Grey



**MC03** Quartz Grey



**MC04** Umbra Grey

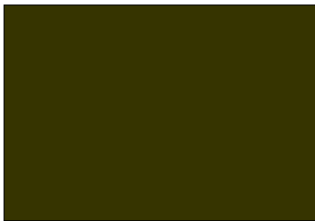

**MC05** Black Brown

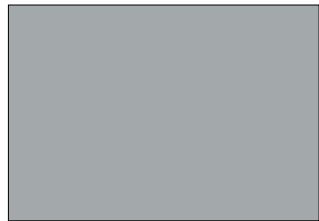

**MC06** Silver



**MC08** Gun Metal

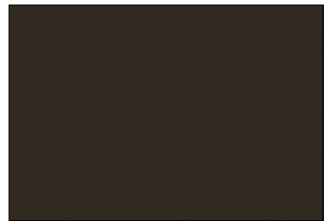

**MC09** Bronze

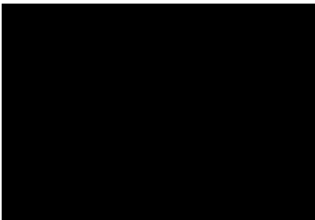

**MC11** Jet Black (Gloss)

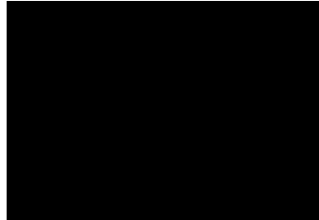

**MC12** Black (Matte)



**MC20** Red

---

## Metal: Premium

---

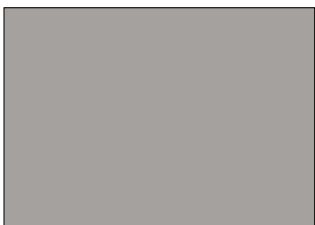

**PM01** Polished Chrome



**PM02** Satin Nickel

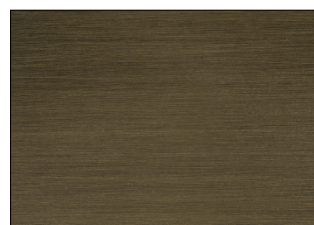

**PM03** Oil Rubbed Bronze



Back Painted Glass: Clear + Etched Matte



**GC01 / GE01** White



**GC24 / GE24** Light Beige



**GC21 / GE21** Taupe

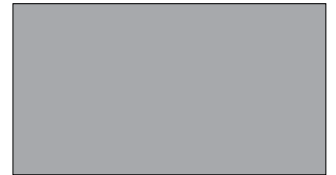

**GC23 / GE23** Light Grey



**GC02 / GE02** Grey

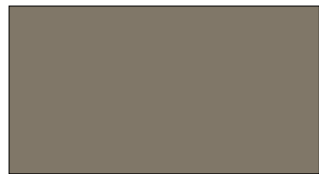

**GC22 / GE22** Quartz Grey



**GC04 / GE04** Coco

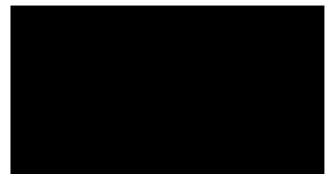

**GC03 / GE03** Black



**GC20 / GE20** Red



**GC00** Clear Glass, no back-paint  
Available on credenzas only

Solid Surface: For additional stone options and pricing please contact your sales representative.

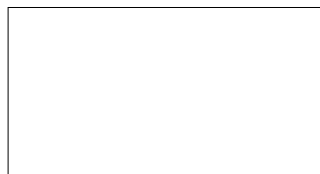

**CS01** Corian, Glacier White

Leather: Spinneybeck Acqua



**AU 0610** North Sea

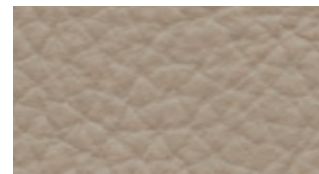

**AU 0605** Tahiti

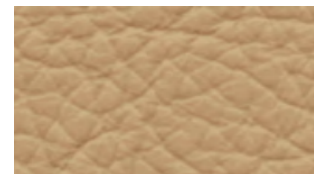

**AU 0607** Lake Como

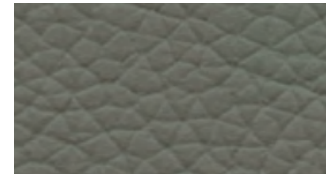

**AU 0614** River Thames

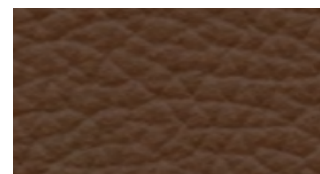

**AU 0647** Straits of Gibraltar

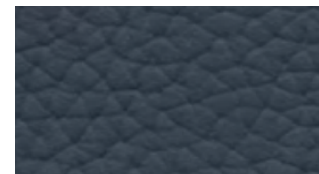

**AU 0631** Cantabrian Sea

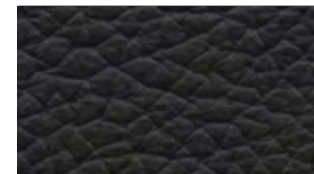

**AU 0642** Longship

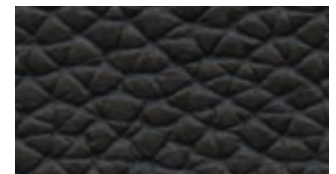

**AU 0617** Black Sea



# Highline Collection

## Highline Conference Tables



**DATESWEISER**

# General Specifications

## Highline Conference Tables

### Overall Elevations and Clearance

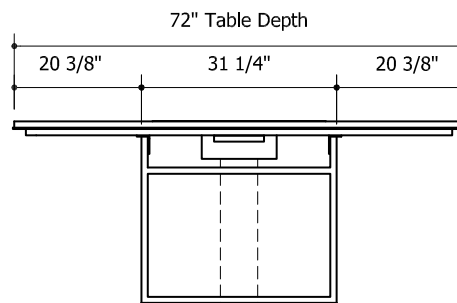
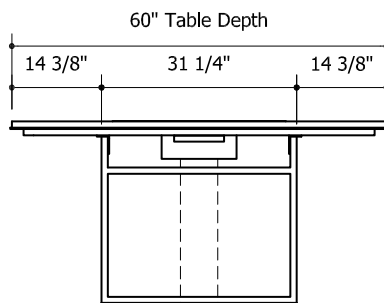
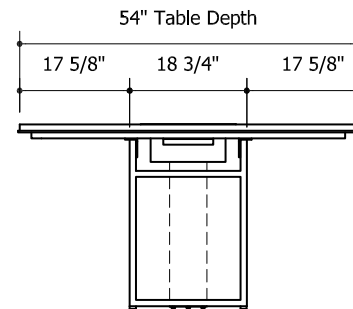
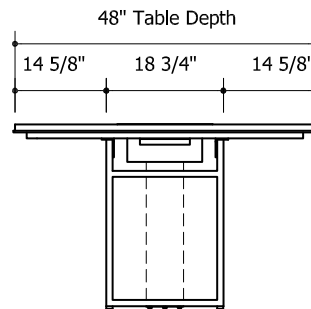
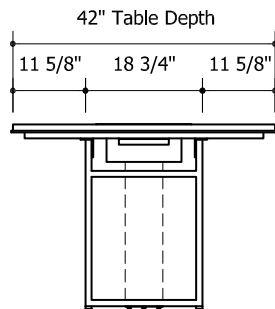
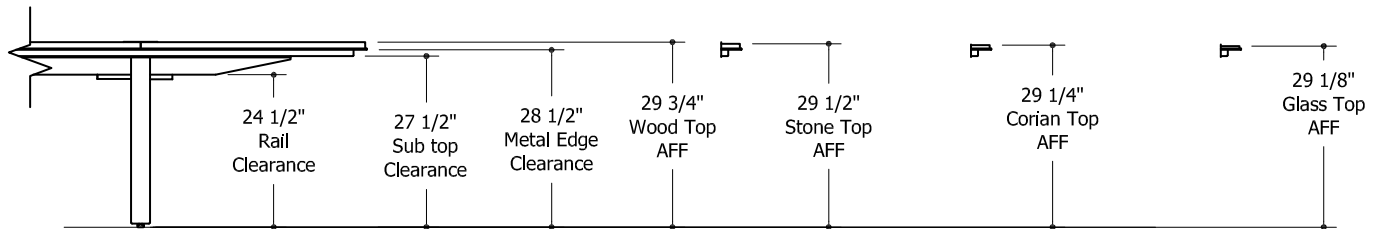

# General Specifications

## Highline Conference Tables

### Top Construction

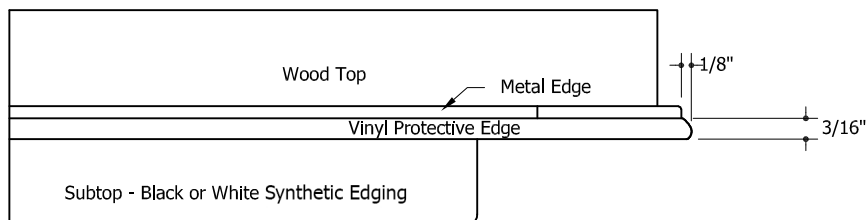
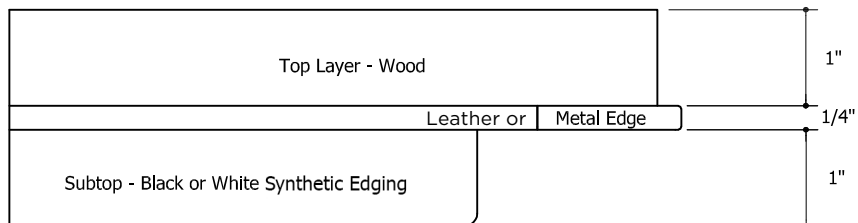
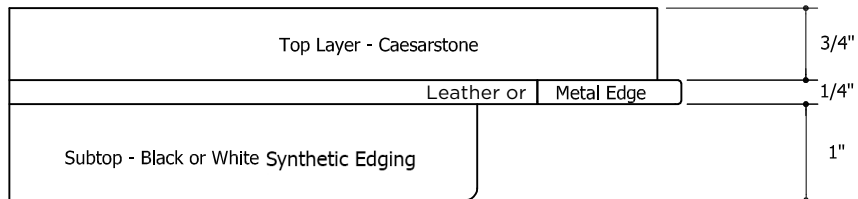
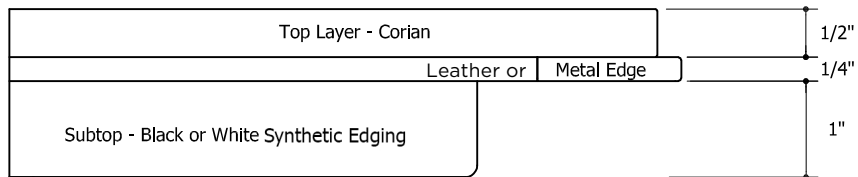
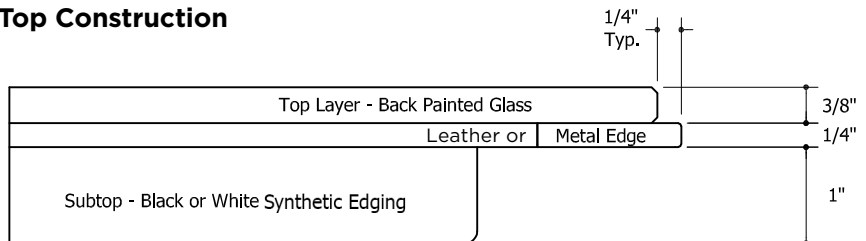

# General Specifications

## Highline Conference Tables

### Base Construction / Wire Management

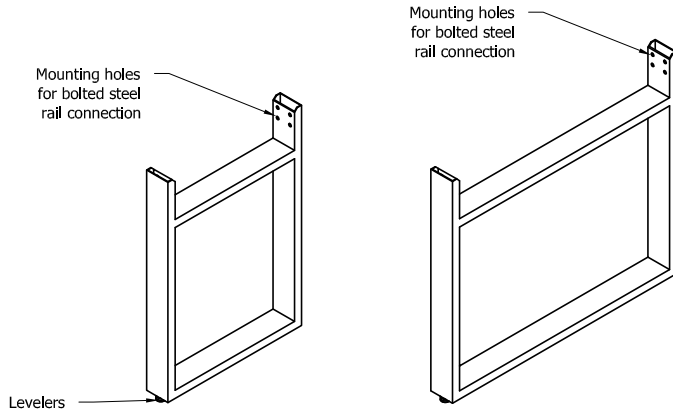

#### Highline Small Base

- Used on 42" / 48" / 54" widths
- Also used in combination with large bases for some elliptical and trapezoid configurations
- Construction: 1" x 3" tubular steel

#### Highline Large Base

- Used on 60" / 72" widths
- Also used in combination with small bases for some elliptical and trapezoid configurations
- Construction: 1" x 3" tubular steel

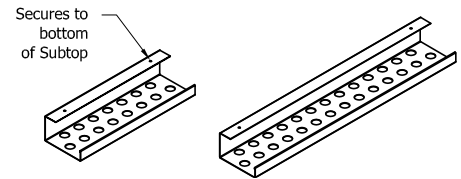

#### Wire Manager

- Length varies by table 16" or 28" x 5" deep x 3" high
- Construction: Steel with black powder coat metallic finish (MC12)

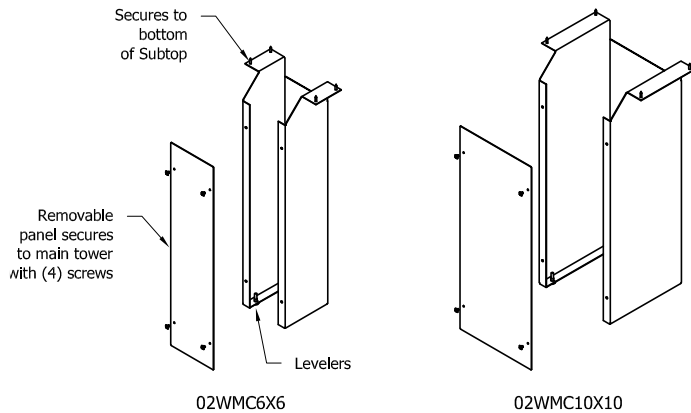

#### Wire Management Column

- Ordered separately but required with all power options
- Location is flexible but placement on table centerline is recommended

Pattern No.	MC__	PM01/PM02	PM03
02WMC6X6	\$648	\$1,723	\$2,430
02WMC10X10	\$1,178	\$1,826	\$4,138

02WMC6X6 6" x 6" with clear inside of 4" x 5"  
 02WMC10X10 10" x 10" with clear inside of 8" x 9"

# General Specifications

## Highline Conference Tables

### Table Top Power / Connectivity Layout

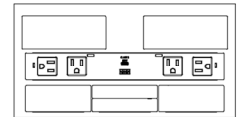
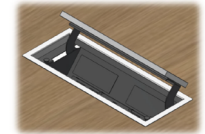
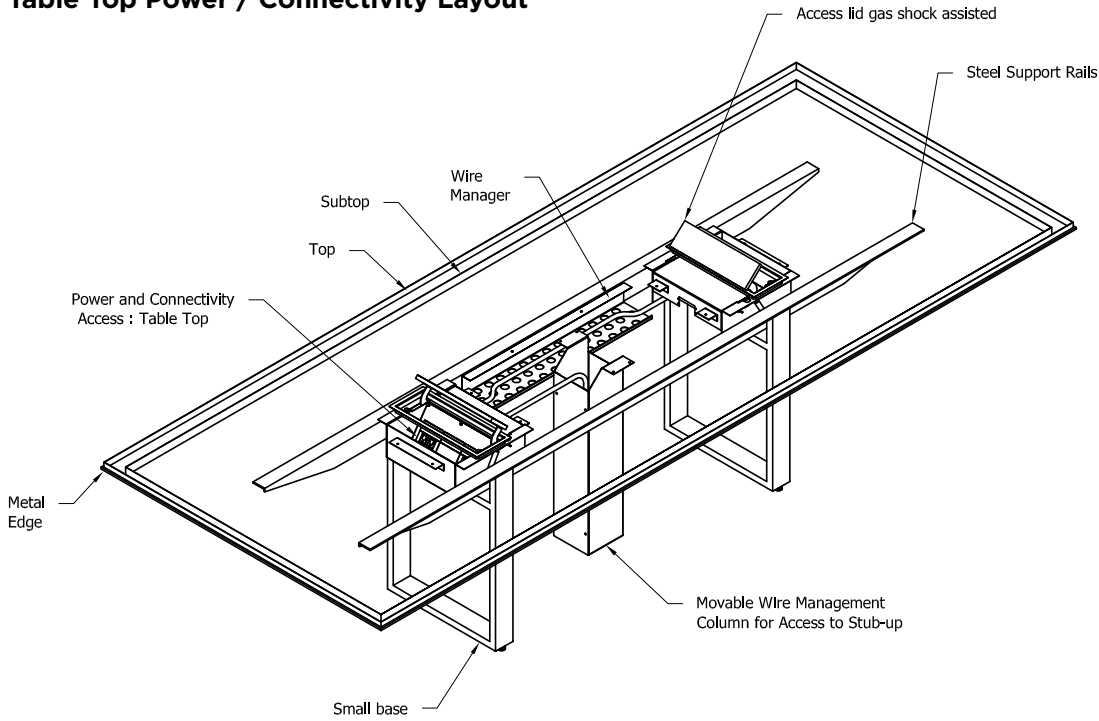

Single-Sided Conference Table Topmount

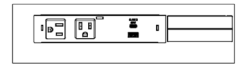
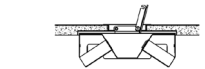

Double-Sided Conference Table Topmount (Both Sides)

### Undermount Power / Connectivity Layout

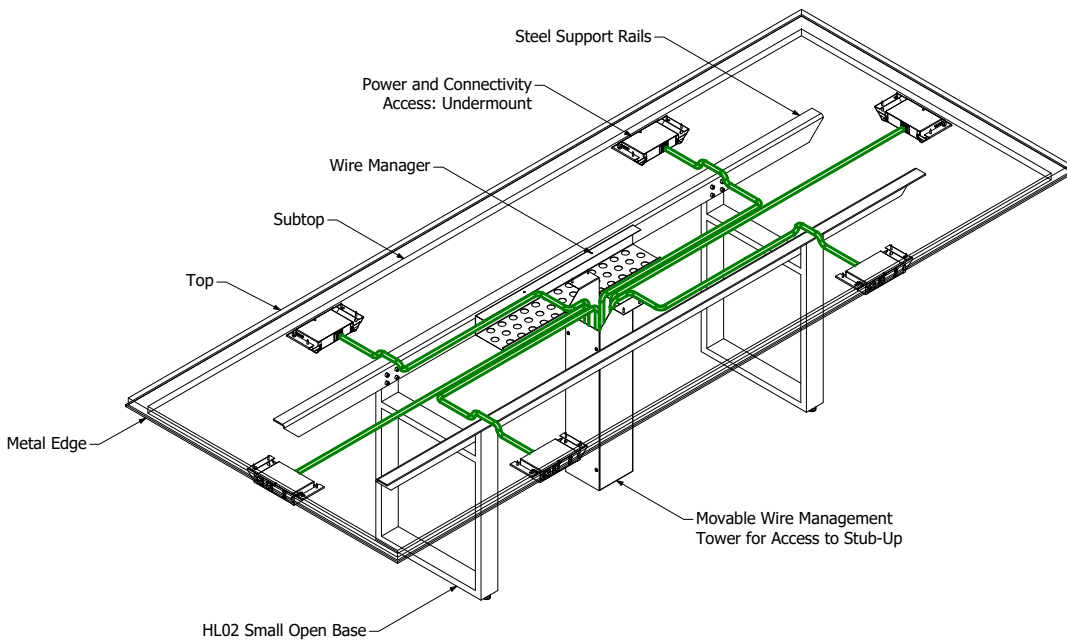

Undermount Power

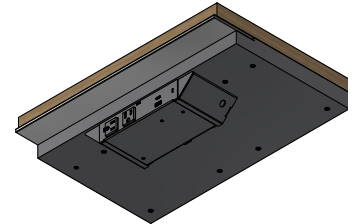

Edgemount Power

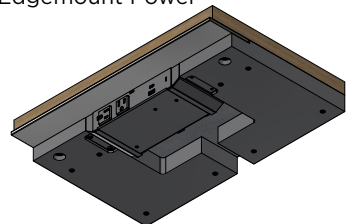

# General Specifications

## Highline Conference Tables

---

### Undermount Power / Connectivity Layout

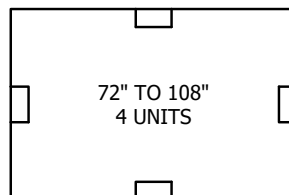
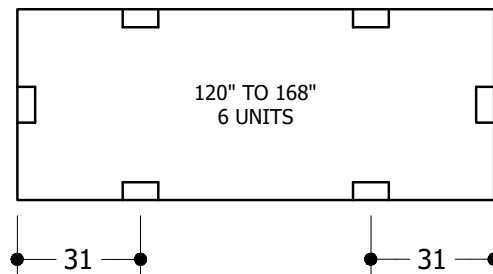
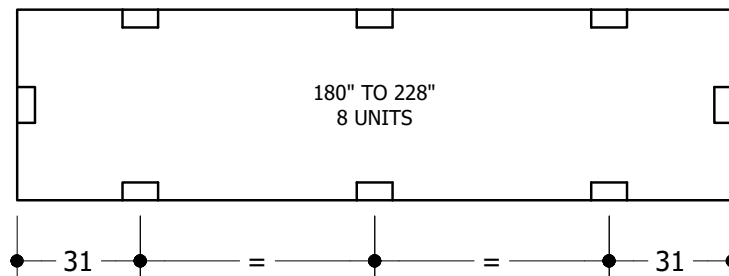
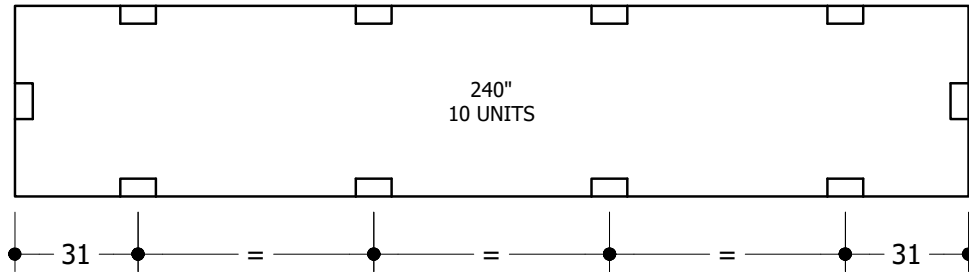

POWER LOCATIONS & QUANTITY BY TABLE LENGTH





# Rectangular Conference Tables

## 42"-48" Deep Tops

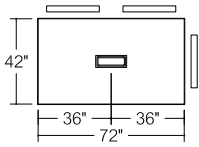
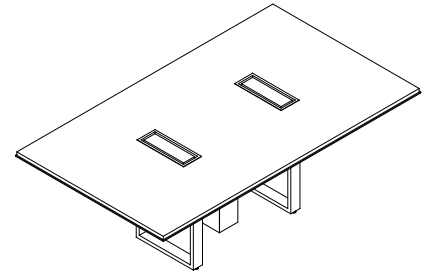

**02R42X72**  
6 Person Table

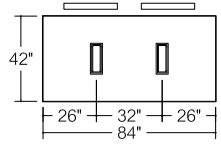

**02R42X84**  
6 Person Table

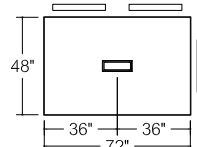

**02R48X72**  
6 Person Table

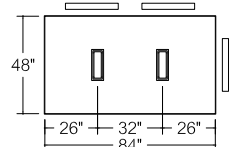

**02R48X84**  
6 Person Table

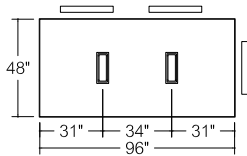

**02R48X96**  
6 - 8 Person Table

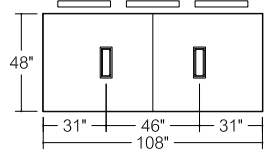

**02R48X108**  
8 Person Table

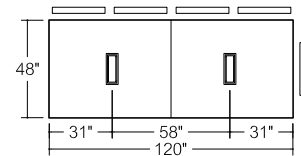

**02R48X120**  
10 Person Table

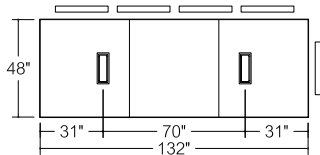

**02R48X132**  
10 Person Table

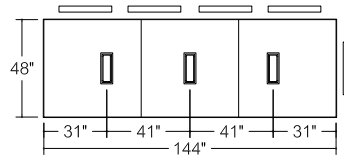

**02R48X144**  
10 Person Table

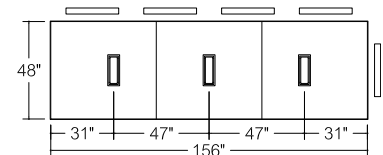

**02R48X156**  
10 - 12 Person Table

# Rectangular Conference Tables

## 42"-48" Deep Tops

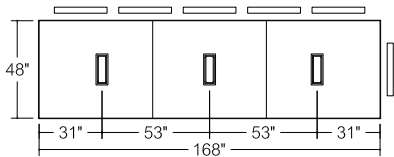
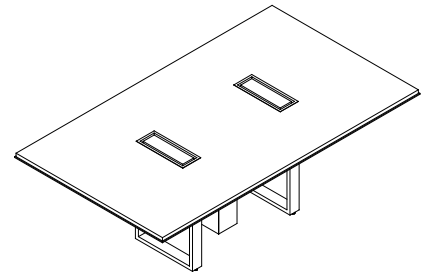

**02R48X168**

12 Person Table

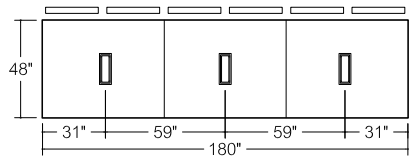

**02R48X180**

14 Person Table

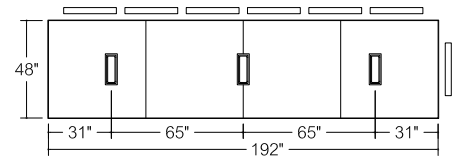

**02R48X192**

14 Person Table

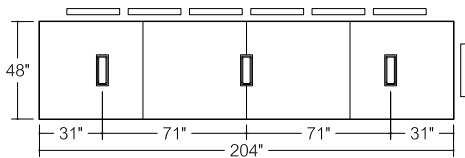

**02R48X204**

14 Person Table

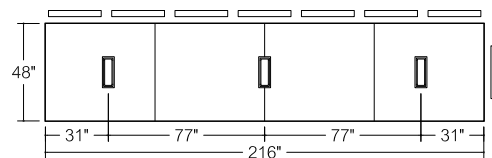

**02R48X216**

16 Person Table

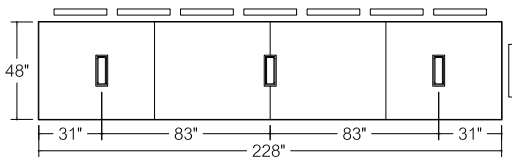

**02R48X228**

16 Person Table

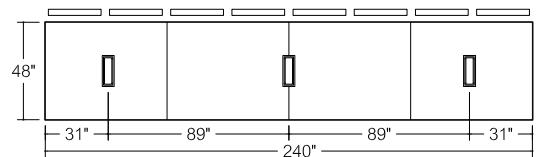

**02R48X240**

18 Person Table

# Rectangular Conference Tables

## 42"-48" Deep Tops

### Veneer Top

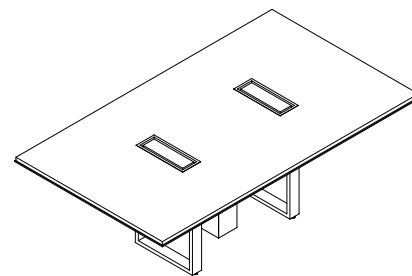

D	W	Pattern No.	T1__ Top	T2__ Top	PM01/ PM02 Edge Upcharge	PM03 Edge Upcharge	AU__ Edge Upcharge	PM01/ PM02 Base Upcharge	PM03 Base Upcharge
42"	72"	<b>02R42X72</b>	\$11,944	\$12,589	\$909	\$909	\$2,179	\$429	\$841
42"	84"	<b>02R42X84</b>	12,794	13,543	1,078	1,078	2,407	429	841
48"	72"	<b>02R48X72</b>	12,389	13,124	940	940	2,292	429	841
48"	84"	<b>02R48X84</b>	13,324	14,184	1,465	1,465	2,523	429	841
48"	96"	<b>02R48X96</b>	13,878	14,857	1,465	1,465	2,751	429	841
48"	108"	<b>02R48X108</b>	15,038	16,144	1,465	1,465	2,981	429	841
48"	120"	<b>02R48X120</b>	16,206	17,434	1,527	1,527	3,210	429	841
48"	132"	<b>02R48X132</b>	19,871	21,221	1,528	1,528	3,439	429	841
48"	144"	<b>02R48X144</b>	20,910	22,383	1,527	1,527	3,669	644	1,260
48"	156"	<b>02R48X156</b>	21,716	23,309	1,527	1,527	3,899	644	1,260
48"	168"	<b>02R48X168</b>	23,008	24,724	2,513	2,513	4,128	644	1,260
48"	180"	<b>02R48X180</b>	23,944	25,425	2,513	2,513	4,356	644	1,260
48"	192"	<b>02R48X192</b>	24,959	26,920	2,513	2,513	4,587	644	1,260
48"	204"	<b>02R48X204</b>	26,232	28,317	2,513	2,513	4,816	644	1,260
48"	216"	<b>02R48X216</b>	26,875	29,081	2,513	2,513	5,044	644	1,260
48"	228"	<b>02R48X228</b>	27,813	30,146	2,513	2,513	5,313	644	1,260
48"	240"	<b>02R48X240</b>	28,773	31,227	2,513	2,513	5,503	644	1,260

Order Code	Specification Information	Refer To Accessories Section	Pricing Tiers
Example: <b>02R42X72-T003-PM01-MC01-GM2-MC01-UCO</b>	<b>To order please specify pattern number including:</b>	Please refer to Accessories section, <b>page 213</b> for power details.	Please refer to Materials and Finish <b>page 9</b> for specification details.
<b>02</b> Highline Collection	1. Top finish	<b>Grommet options available in these finishes:</b>	T1 and T2 pricing includes powder coated base finish.
<b>R</b> Rectangular	2. Trim Finish (only applies if trim type is metal or leather)	Powder coated	There is an upcharge for plated base finishes as highlighted above.
<b>42</b> Depth	3. Base finish	Premium (Polished Chrome, Satin Nickel or Oil Rubbed Bronze)	For additional stone options and pricing please contact your sales representative."
<b>72</b> Width	4. Grommet option	<b>Power Box Options</b>	
<b>T003</b> Top Finish	5. Grommet finish (only applies if grommets are selected)	<b>Code: Description:</b>	
<b>PM01</b> Trim Finish	6. Power box option	NP No Power	
<b>MC01</b> Base Finish	7. Table-top power finish (only applies if table-top power is selected)	UCO Undermount	
<b>GM2</b> Grommet Opt.	<b>Trim Type</b>	ECO Edgemount	
<b>MC01</b> Grommet Finish	N = No trim	T1E Tabletop 1-Sided Lid	
<b>UCO</b> Undermount	M = Metal (available in Premium and Powder Coat finishes)	T2C Tabletop 2-Sided Lid	
	L = Leather	<b>Must select Wire Management Column and Finish:</b>	
		Powder coated	
		Premium (Polished Chrome, Satin Nickel or Oil Rubbed Bronze)	

# Rectangular Conference Tables

## 42"-48" Deep Tops

### Glass Top

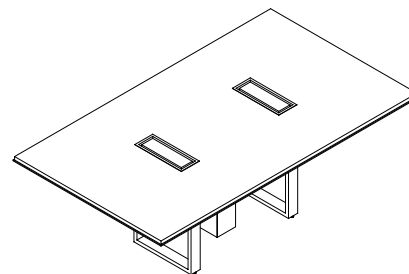

D	W	Pattern No.	GC__ Top	GE__ Top	PM01/ PM02 Edge Upcharge	PM03 Edge Upcharge	AU__ Edge Upcharge	PM01/ PM02 Base Upcharge	PM03 Base Upcharge
42"	72"	<b>02R42X72</b>	\$15,339	\$15,923	\$909	\$909	\$2,179	\$429	\$841
42"	84"	<b>02R42X84</b>	16,703	17,386	1,078	1,078	2,407	429	841
48"	72"	<b>02R48X72</b>	16,212	16,879	940	940	2,292	429	841
48"	84"	<b>02R48X84</b>	17,738	18,517	1,465	1,465	2,523	429	841
48"	96"	<b>02R48X96</b>	18,865	19,755	1,465	1,465	2,751	429	841
48"	108"	<b>02R48X108</b>	20,625	21,626	1,465	1,465	2,981	429	841
48"	120"	<b>02R48X120</b>	22,393	23,505	1,527	1,527	3,210	429	841
48"	132"	<b>02R48X132</b>	26,762	27,986	1,528	1,528	3,439	429	841
48"	144"	<b>02R48X144</b>	28,397	29,730	1,527	1,527	3,669	644	1,260
48"	156"	<b>02R48X156</b>	29,787	31,231	1,527	1,527	3,899	644	1,260
48"	168"	<b>02R48X168</b>	31,683	33,238	2,513	2,513	4,128	644	1,260
48"	180"	<b>02R48X180</b>	32,835	34,503	2,513	2,513	4,356	644	1,260
48"	192"	<b>02R48X192</b>	34,816	36,594	2,513	2,513	4,587	644	1,260
48"	204"	<b>02R48X204</b>	36,695	38,584	2,513	2,513	4,816	644	1,260
48"	216"	<b>02R48X216</b>	37,913	39,913	2,513	2,513	5,044	644	1,260
48"	228"	<b>02R48X228</b>	39,445	41,555	2,513	2,513	5,313	644	1,260
48"	240"	<b>02R48X240</b>	40,992	43,215	2,513	2,513	5,503	644	1,260

Order Code	Specification Information	Refer To Accessories Section	Pricing Tiers
Example: <b>02R42X72-GE01-PM01-MC01-GM2-MC01-UCO</b>	<b>To order please specify pattern number including:</b>	Please refer to Accessories section, <b>page 213</b> for power details.	Please refer to Materials and Finish <b>page 9</b> for specification details.
<b>02</b> Highline Collection	1. Top finish	<b>Grommet options available in these finishes:</b>	T1 and T2 pricing includes powder coated base finish.
<b>R</b> Rectangular	2. Trim Finish (only applies if trim type is metal or leather)	Powder coated	There is an upcharge for plated base finishes as highlighted above.
<b>42</b> Depth	3. Base finish	Premium (Polished Chrome, Satin Nickel or Oil Rubbed Bronze)	For additional stone options and pricing please contact your sales representative."
<b>72</b> Width	4. Grommet option	<b>Power Box Options</b>	
<b>GE01</b> Top Finish	5. Grommet finish (only applies if grommets are selected)	<b>Code: Description:</b>	
<b>PM01</b> Trim Finish	6. Power box option	NP No Power	
<b>MC01</b> Base Finish	7. Table-top power finish (only applies if table-top power is selected)	UCO Undermount	
<b>GM2</b> Grommet Opt.	Trim Type	ECO Edgemount	
<b>MC01</b> Grommet Finish	N = No trim	T1E Tabletop 1-Sided Lid	
<b>UCO</b> Undermount	M = Metal (available in Premium and Powder Coat finishes)	T2C Tabletop 2-Sided Lid	
	L = Leather	<b>Must select Wire Management Column and Finish:</b>	
		Powder coated	
		Premium (Polished Chrome, Satin Nickel or Oil Rubbed Bronze)	

# Rectangular Conference Tables

**42"-48" Deep Tops**

**Corian Top**

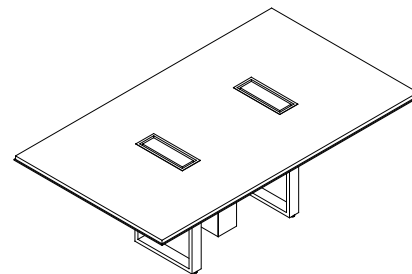

D	W	Pattern No.	CS01 Top	PM01/ PM02 Edge Upcharge	PM03 Edge Upcharge	AU__ Edge Upcharge	PM01/PM02 Base Upcharge	PM03 Base Upcharge
42"	72"	<b>02R42X72</b>	\$16,003	\$909	\$909	\$2,179	\$429	\$841
42"	84"	<b>02R42X84</b>	17,529	1,078	1,078	2,407	429	841
48"	72"	<b>02R48X72</b>	17,027	940	940	2,292	429	841
48"	84"	<b>02R48X84</b>	18,737	1,465	1,465	2,523	429	841
48"	96"	<b>02R48X96</b>	20,063	1,465	1,465	2,751	429	841
48"	108"	<b>02R48X108</b>	21,997	1,465	1,465	2,981	429	841
48"	120"	<b>02R48X120</b>	23,939	1,527	1,527	3,210	429	841
48"	132"	<b>02R48X132</b>	28,376	1,528	1,528	3,439	429	841
48"	144"	<b>02R48X144</b>	30,189	1,527	1,527	3,669	644	1,260
48"	156"	<b>02R48X156</b>	31,768	1,527	1,527	3,899	644	1,260
48"	168"	<b>02R48X168</b>	33,832	2,513	2,513	4,128	644	1,260
48"	180"	<b>02R48X180</b>	35,183	2,513	2,513	4,356	644	1,260
48"	192"	<b>02R48X192</b>	37,328	2,513	2,513	4,587	644	1,260
48"	204"	<b>02R48X204</b>	39,376	2,513	2,513	4,816	644	1,260
48"	216"	<b>02R48X216</b>	40,792	2,513	2,513	5,044	644	1,260
48"	228"	<b>02R48X228</b>	42,504	2,513	2,513	5,313	644	1,260
48"	240"	<b>02R48X240</b>	44,235	2,513	2,513	5,503	644	1,260

Order Code	Specification Information	Refer To Accessories Section	Pricing Tiers
Example: <b>02R42X72-CS01-PM01-MC01-GM2-MC01-UCO</b>	<b>To order please specify pattern number including:</b>	Please refer to Accessories section, <b>page 213</b> for power details.	Please refer to Materials and Finish <b>page 9</b> for specification details.
<b>02</b> Highline Collection	1. Top finish	<b>Grommet options available in these finishes:</b>	T1 and T2 pricing includes powder coated base finish.
<b>R</b> Rectangular	2. Trim Finish (only applies if trim type is metal or leather)	Powder coated	There is an upcharge for plated base finishes as highlighted above.
<b>42</b> Depth	3. Base finish	Premium (Polished Chrome, Satin Nickel or Oil Rubbed Bronze)	For additional stone options and pricing please contact your sales representative."
<b>72</b> Width	4. Grommet option	<b>Power Box Options</b>	
<b>CS01</b> Top Finish	5. Grommet finish (only applies if grommets are selected)	<b>Code: Description:</b>	
<b>PM01</b> Trim Finish	6. Power box option	NP No Power	
<b>MC01</b> Base Finish	7. Table-top power finish (only applies if table-top power is selected)	UCO Undermount	
<b>GM2</b> Grommet Opt.	<b>Trim Type</b>	ECO Edgemount	
<b>MC01</b> Grommet Finish	N = No trim	T1E Tabletop 1-Sided Lid	
<b>UCO</b> Undermount	M = Metal (available in Premium and Powder Coat finishes)	T2C Tabletop 2-Sided Lid	
	L = Leather	<b>Must select Wire Management Column and Finish:</b>	
		Powder coated	
		Premium (Polished Chrome, Satin Nickel or Oil Rubbed Bronze)	



# Rectangular Conference Tables

## 54" Deep Tops

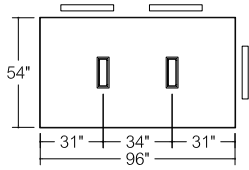
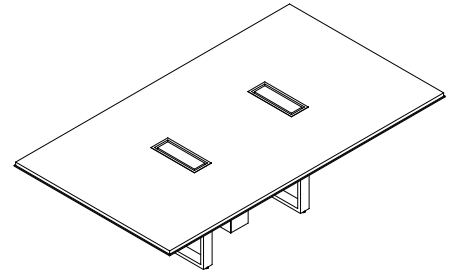

**02R54X96**

6 - 8 Person Table

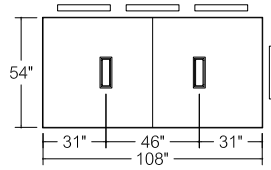

**02R54X108**

8 Person Table

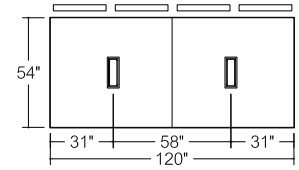

**02R54X120**

10 Person Table

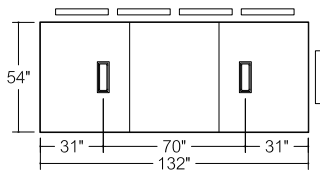

**02R54X132**

10 Person Table

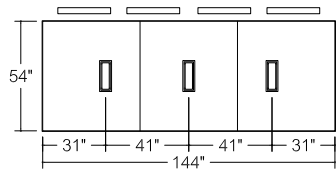

**02R54X144**

10 Person Table

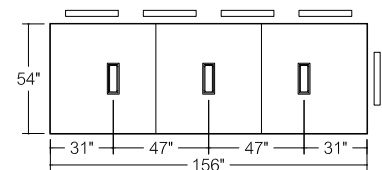

**02R54X156**

10 - 12 Person Table

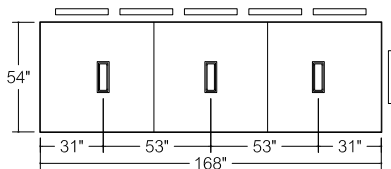

**02R54X168**

12 Person Table

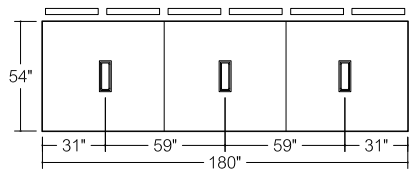

**02R54X180**

14 Person Table

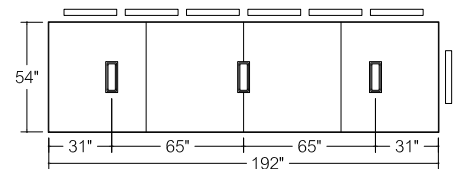

**02R54X192**

14 Person Table



# Rectangular Conference Tables

**54" Deep Tops**

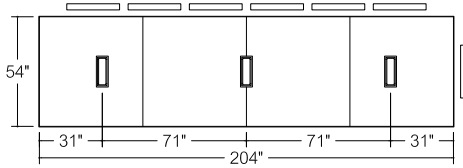
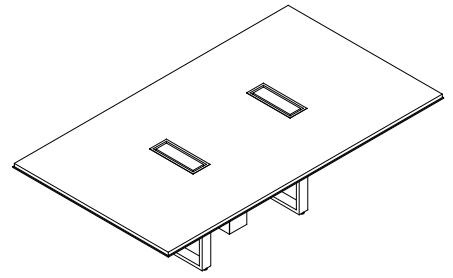

**02R54X204**

14 Person Table

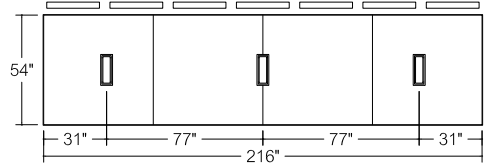

**02R54X216**

16 Person Table

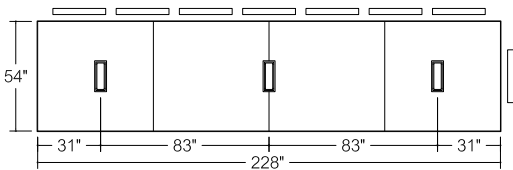

**02R54X228**

16 Person Table

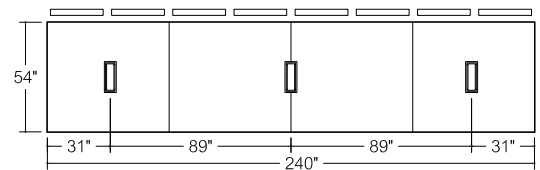

**02R54X240**

18 Person Table

# Rectangular Conference Tables

## 54" Deep Tops

### Veneer Top

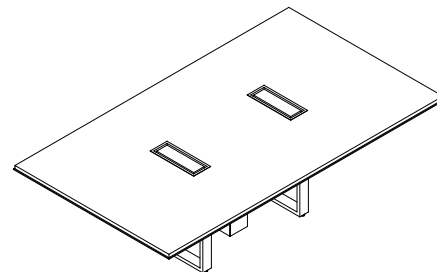

D	W	Pattern No.	T1__ Top	T2__ Top	PM01/ PM02 Edge Upcharge	PM03 Edge Upcharge	AU__ Edge Upcharge	PM01/ PM02 Base Upcharge	PM03 Base Upcharge
54"	96"	<b>02R54X96</b>	\$15,656	\$16,759	\$1,499	\$1,499	\$2,866	\$429	\$841
54"	108"	<b>02R54X108</b>	16,962	18,205	1,499	1,499	3,095	429	841
54"	120"	<b>02R54X120</b>	18,279	19,657	1,499	1,499	3,325	429	841
54"	132"	<b>02R54X132</b>	22,421	23,940	1,708	1,708	3,553	429	841
54"	144"	<b>02R54X144</b>	23,592	25,247	1,708	1,708	3,782	644	1,260
54"	156"	<b>02R54X156</b>	24,213	26,005	1,708	1,708	4,013	644	1,260
54"	168"	<b>02R54X168</b>	25,655	27,589	2,547	2,547	4,241	644	1,260
54"	180"	<b>02R54X180</b>	26,350	28,419	2,547	2,547	4,470	644	1,260
54"	192"	<b>02R54X192</b>	28,892	31,100	2,547	2,547	4,701	644	1,260
54"	204"	<b>02R54X204</b>	29,600	31,944	2,547	2,547	4,930	644	1,260
54"	216"	<b>02R54X216</b>	30,322	32,806	2,547	2,547	5,159	644	1,260
54"	228"	<b>02R54X228</b>	31,008	33,629	2,547	2,547	5,388	644	1,260
54"	240"	<b>02R54X240</b>	31,723	34,482	2,547	2,547	5,618	644	1,260

Order Code	Specification Information	Refer To Accessories Section	Pricing Tiers
Example: <b>02R54X96-T003-PM01-MC01-GM2-MC01-UCO</b>	<b>To order please specify pattern number including:</b>	Please refer to Accessories section, <b>page 213</b> for power details.	Please refer to Materials and Finish <b>page 9</b> for specification details.
<b>02</b> Highline Collection	1. Top finish	<b>Grommet options available in these finishes:</b>	T1 and T2 pricing includes powder coated base finish.
<b>R</b> Rectangular	2. Trim Finish (only applies if trim type is metal or leather)	Powder coated	There is an upcharge for plated base finishes as highlighted above.
<b>54</b> Depth	3. Base finish	Premium (Polished Chrome, Satin Nickel or Oil Rubbed Bronze)	For additional stone options and pricing please contact your sales representative."
<b>96</b> Width	4. Grommet option	<b>Power Box Options</b>	
<b>T003</b> Top Finish	5. Grommet finish (only applies if grommets are selected)	<b>Code: Description:</b>	
<b>PM01</b> Trim Finish	6. Power box option	NP No Power	
<b>MC01</b> Base Finish	7. Table-top power finish (only applies if table-top power is selected)	UCO Undermount	
<b>GM2</b> Grommet Opt.	<b>Trim Type</b>	ECO Edgemount	
<b>MC01</b> Grommet Finish	N = No trim	T1E Tabletop 1-Sided Lid	
<b>UCO</b> Undermount	M = Metal (available in Premium and Powder Coat finishes)	T2C Tabletop 2-Sided Lid	
	L = Leather	<b>Must select Wire Management Column and Finish:</b>	
		Powder coated	
		Premium (Polished Chrome, Satin Nickel or Oil Rubbed Bronze)	

# Rectangular Conference Tables

## 54" Deep Tops

### Glass Top

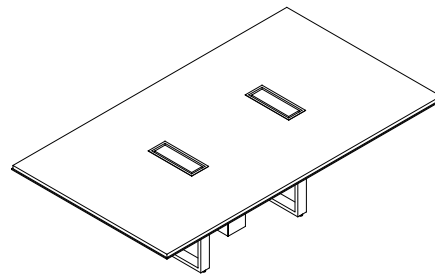

D	W	Pattern No.	GC__ Top	GE__ Top	PM01/ PM02 Edge Upcharge	PM03 Edge AU__ Edge Upcharge	PM01/ PM02 Base Upcharge	PM03 Base Upcharge	
54"	96"	<b>02R54X96</b>	\$21,267	\$22,267	\$1,499	\$1,499	\$2,866	\$429	\$841
54"	108"	<b>02R54X108</b>	23,251	24,375	1,499	1,499	3,095	429	841
54"	120"	<b>02R54X120</b>	25,239	26,488	1,499	1,499	3,325	429	841
54"	132"	<b>02R54X132</b>	30,177	31,552	1,708	1,708	3,553	429	841
54"	144"	<b>02R54X144</b>	32,016	33,517	1,708	1,708	3,782	644	1,260
54"	156"	<b>02R54X156</b>	33,282	34,907	1,708	1,708	4,013	644	1,260
54"	168"	<b>02R54X168</b>	35,407	37,156	2,547	2,547	4,241	644	1,260
54"	180"	<b>02R54X180</b>	36,747	38,621	2,547	2,547	4,470	644	1,260
54"	192"	<b>02R54X192</b>	40,015	42,017	2,547	2,547	4,701	644	1,260
54"	204"	<b>02R54X204</b>	41,372	43,499	2,547	2,547	4,930	644	1,260
54"	216"	<b>02R54X216</b>	42,743	44,995	2,547	2,547	5,159	644	1,260
54"	228"	<b>02R54X228</b>	44,080	46,455	2,547	2,547	5,388	644	1,260
54"	240"	<b>02R54X240</b>	45,443	47,944	2,547	2,547	5,618	644	1,260

Order Code	Specification Information	Refer To Accessories Section	Pricing Tiers
Example: <b>02R54X96-GE01-PM01-MC01-GM2-MC01-UCO</b>	<b>To order please specify pattern number including:</b>	Please refer to Accessories section, <b>page 213</b> for power details.	Please refer to Materials and Finish <b>page 9</b> for specification details.
<b>02</b> Highline Collection	1. Top finish	<b>Grommet options available in these finishes:</b>	T1 and T2 pricing includes powder coated base finish.
<b>R</b> Rectangular	2. Trim Finish (only applies if trim type is metal or leather)	Powder coated	There is an upcharge for plated base finishes as highlighted above.
<b>54</b> Depth	3. Base finish	Premium (Polished Chrome, Satin Nickel or Oil Rubbed Bronze)	For additional stone options and pricing please contact your sales representative."
<b>96</b> Width	4. Grommet option	<b>Power Box Options</b>	
<b>GE01</b> Top Finish	5. Grommet finish (only applies if grommets are selected)	<b>Code: Description:</b>	
<b>PM01</b> Trim Finish	6. Power box option	NP No Power	
<b>MC01</b> Base Finish	7. Table-top power finish (only applies if table-top power is selected)	UCO Undermount	
<b>GM2</b> Grommet Opt.	<b>Trim Type</b>	ECO Edgemount	
<b>MC01</b> Grommet Finish	N = No trim	T1E Tabletop 1-Sided Lid	
<b>UCO</b> Undermount	M = Metal (available in Premium and Powder Coat finishes)	T2C Tabletop 2-Sided Lid	
	L = Leather	<b>Must select Wire Management Column and Finish:</b>	
		Powder coated	
		Premium (Polished Chrome, Satin Nickel or Oil Rubbed Bronze)	

# Rectangular Conference Tables

**54" Deep Tops**  
**Corian Top**

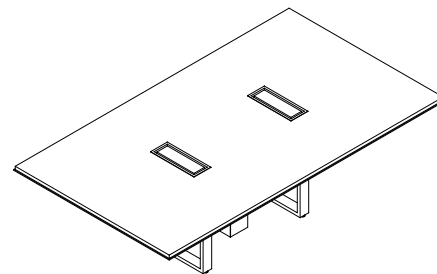

D	W	Pattern No.	CS01 Top	PM01/ PM02 Edge Upcharge	PM03 Edge Upcharge	AU__ Edge Upcharge	PM01/ PM02 Base Upcharge	PM03 Base Upcharge
54"	96"	<b>02R54X96</b>	\$22,614	\$1,499	\$1,499	\$2,866	\$429	\$841
54"	108"	<b>02R54X108</b>	24,790	1,499	1,499	3,095	429	841
54"	120"	<b>02R54X120</b>	26,974	1,499	1,499	3,325	429	841
54"	132"	<b>02R54X132</b>	31,989	1,708	1,708	3,553	429	841
54"	144"	<b>02R54X144</b>	34,028	1,708	1,708	3,782	644	1,260
54"	156"	<b>02R54X156</b>	35,520	1,708	1,708	4,013	644	1,260
54"	168"	<b>02R54X168</b>	37,833	2,547	2,547	4,241	644	1,260
54"	180"	<b>02R54X180</b>	39,397	2,547	2,547	4,470	644	1,260
54"	192"	<b>02R54X192</b>	42,810	2,547	2,547	4,701	644	1,260
54"	204"	<b>02R54X204</b>	44,386	2,547	2,547	4,930	644	1,260
54"	216"	<b>02R54X216</b>	45,980	2,547	2,547	5,159	644	1,260
54"	228"	<b>02R54X228</b>	47,534	2,547	2,547	5,388	644	1,260
54"	240"	<b>02R54X240</b>	49,120	2,547	2,547	5,618	644	1,260

Order Code	Specification Information	Refer To Accessories Section	Pricing Tiers
Example: <b>02R54X96-CS01-PM01-MC01-GM2-MC01-UCO</b>	<b>To order please specify pattern number including:</b>	Please refer to Accessories section, <b>page 213</b> for power details.	Please refer to Materials and Finish <b>page 9</b> for specification details.
<b>02</b> Highline Collection	1. Top finish	<b>Grommet options available in these finishes:</b>	T1 and T2 pricing includes powder coated base finish.
<b>R</b> Rectangular	2. Trim Finish (only applies if trim type is metal or leather)	Powder coated	There is an upcharge for plated base finishes as highlighted above.
<b>54</b> Depth	3. Base finish	Premium (Polished Chrome, Satin Nickel or Oil Rubbed Bronze)	For additional stone options and pricing please contact your sales representative."
<b>96</b> Width	4. Grommet option	<b>Power Box Options</b>	
<b>CS01</b> Top Finish	5. Grommet finish (only applies if grommets are selected)	<b>Code: Description:</b>	
<b>PM01</b> Trim Finish	6. Power box option	NP No Power	
<b>MC01</b> Base Finish	7. Table-top power finish (only applies if table-top power is selected)	UCO Undermount	
<b>GM2</b> Grommet Opt.	<b>Trim Type</b>	ECO Edgemount	
<b>MC01</b> Grommet Finish	N = No trim	T1E Tabletop 1-Sided Lid	
<b>UCO</b> Undermount	M = Metal (available in Premium and Powder Coat finishes)	T2C Tabletop 2-Sided Lid	
	L = Leather	<b>Must select Wire Management Column and Finish:</b>	
		Powder coated	
		Premium (Polished Chrome, Satin Nickel or Oil Rubbed Bronze)	



# Rectangular Conference Tables

## 60" Deep Tops

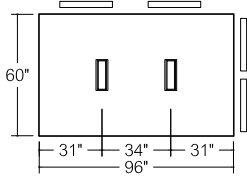
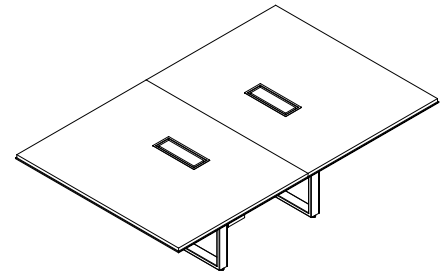

**O2R60X96**  
8 Person Table

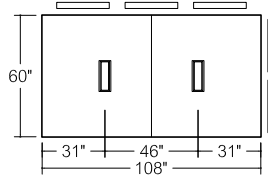

**O2R60X108**  
10 Person Table

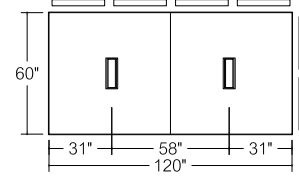

**O2R60X120**  
12 Person Table

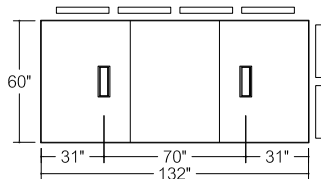

**O2R60X132**  
12 Person Table

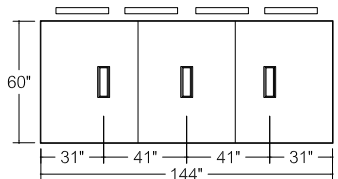

**O2R60X144**  
12 Person Table

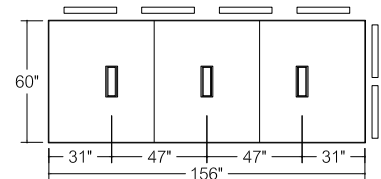

**O2R60X156**  
12 Person Table

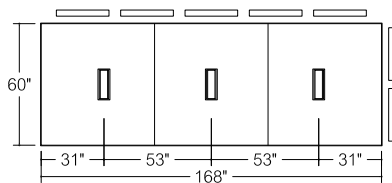

**O2R60X168**  
14 Person Table

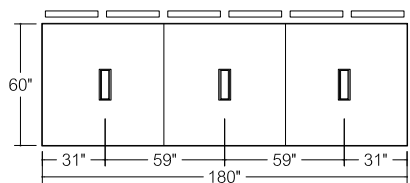

**O2R60X180**  
16 Person Table

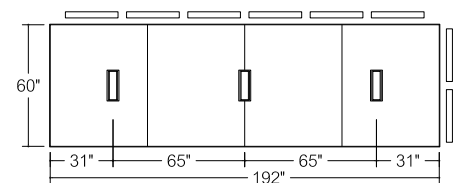

**O2R60X192**  
16 Person Table

# Rectangular Conference Tables

## 60" Deep Tops

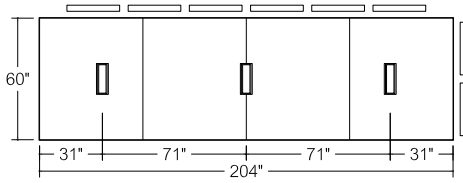
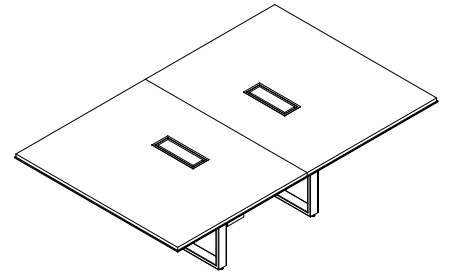

**02R60X204**  
16 Person Table

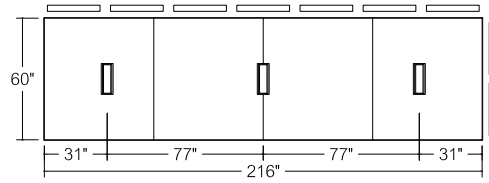

**02R60X216**  
18 Person Table

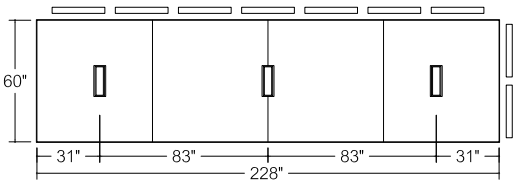

**02R60X228**  
18 Person Table

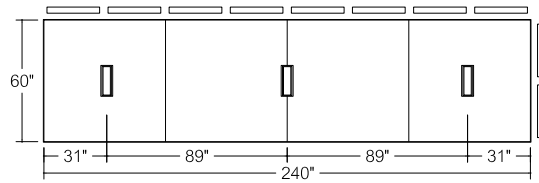

**02R60X240**  
20 Person Table

# Rectangular Conference Tables

**60" Deep Tops**

**Veneer Top**

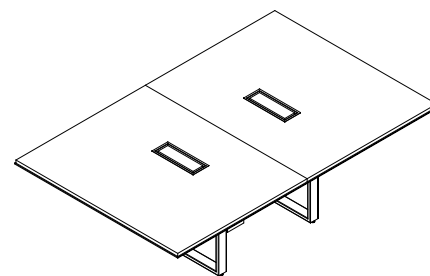

D	W	Pattern No.	T1__ Top	T2__ Top	PM01/ PM02 Edge Upcharge	PM03 Edge Upcharge	AU__ Edge Upcharge	PM01/ PM02 Base Upcharge	PM03 Base Upcharge
60"	96"	<b>02R60X96</b>	\$16,224	\$17,450	\$1,519	\$1,519	\$2,981	\$408	\$1,408
60"	108"	<b>02R60X108</b>	17,479	18,858	1,519	1,519	3,210	408	1,408
60"	120"	<b>02R60X120</b>	18,651	20,182	1,519	1,519	3,439	408	1,408
60"	132"	<b>02R60X132</b>	22,184	23,869	1,731	1,731	3,669	408	1,408
60"	144"	<b>02R60X144</b>	24,482	26,323	1,731	1,731	3,899	611	2,110
60"	156"	<b>02R60X156</b>	25,488	27,481	1,731	1,731	4,128	611	2,110
60"	168"	<b>02R60X168</b>	27,140	29,284	2,560	2,560	4,356	611	2,110
60"	180"	<b>02R60X180</b>	28,256	30,555	2,560	2,560	4,587	611	2,110
60"	192"	<b>02R60X192</b>	29,547	32,000	2,560	2,560	4,816	611	2,110
60"	204"	<b>02R60X204</b>	30,818	33,423	2,560	2,560	5,044	611	2,110
60"	216"	<b>02R60X216</b>	31,909	34,667	2,560	2,560	5,274	611	2,110
60"	228"	<b>02R60X228</b>	33,070	35,983	2,560	2,560	5,503	611	2,110
60"	240"	<b>02R60X240</b>	34,261	37,328	2,560	2,560	5,732	611	2,110

Order Code	Specification Information	Refer To Accessories Section	Pricing Tiers
Example: <b>02R60X96-T003-PM01-MC01-GM2-MC01-UCO</b>	<b>To order please specify pattern number including:</b>	Please refer to Accessories section, <b>page 213</b> for power details.	Please refer to Materials and Finish <b>page 9</b> for specification details.
<b>02</b> Highline Collection	1. Top finish	<b>Grommet options available in these finishes:</b>	T1 and T2 pricing includes powder coated base finish.
<b>R</b> Rectangular	2. Trim Finish (only applies if trim type is metal or leather)	Powder coated	There is an upcharge for plated base finishes as highlighted above.
<b>60</b> Depth	3. Base finish	Premium (Polished Chrome, Satin Nickel or Oil Rubbed Bronze)	For additional stone options and pricing please contact your sales representative."
<b>96</b> Width	4. Grommet option	<b>Power Box Options</b>	
<b>T003</b> Top Finish	5. Grommet finish (only applies if grommets are selected)	<b>Code: Description:</b>	
<b>PM01</b> Trim Finish	6. Power box option	NP No Power	
<b>MC01</b> Base Finish	7. Table-top power finish (only applies if table-top power is selected)	UCO Undermount	
<b>GM2</b> Grommet Opt.	<b>Trim Type</b>	ECO Edgemount	
<b>MC01</b> Grommet Finish	N = No trim	T1E Tabletop 1-Sided Lid	
<b>UCO</b> Undermount	M = Metal (available in Premium and Powder Coat finishes)	T2C Tabletop 2-Sided Lid	
	L = Leather	<b>Must select Wire Management Column and Finish:</b>	
		Powder coated	
		Premium (Polished Chrome, Satin Nickel or Oil Rubbed Bronze)	



# Rectangular Conference Tables

**60" Deep Tops**  
**Glass Top**

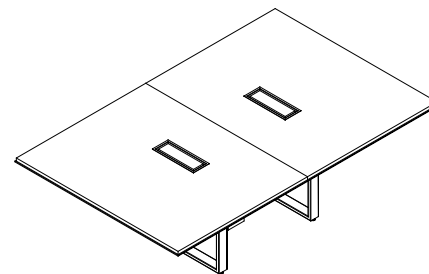

D	W	Pattern No.	GC__ Top	GE__ Top	PM01/ PM02 Edge Upcharge	PM03 Edge Upcharge	AU__ Edge Upcharge	PM01/ PM02 Base Upcharge	PM03 Base Upcharge
60"	96"	<b>02R60X96</b>	\$22,412	\$23,523	\$1,519	\$1,519	\$2,981	\$408	\$1,408
60"	108"	<b>02R60X108</b>	24,405	25,658	1,519	1,519	3,210	408	1,408
60"	120"	<b>02R60X120</b>	26,313	27,703	1,519	1,519	3,439	408	1,408
60"	132"	<b>02R60X132</b>	30,686	32,212	1,731	1,731	3,669	408	1,408
60"	144"	<b>02R60X144</b>	33,771	35,437	1,731	1,731	3,899	611	2,110
60"	156"	<b>02R60X156</b>	35,506	37,313	1,731	1,731	4,128	611	2,110
60"	168"	<b>02R60X168</b>	37,913	39,858	2,560	2,560	4,356	611	2,110
60"	180"	<b>02R60X180</b>	39,766	41,850	2,560	2,560	4,587	611	2,110
60"	192"	<b>02R60X192</b>	41,800	44,023	2,560	2,560	4,816	611	2,110
60"	204"	<b>02R60X204</b>	43,811	46,173	2,560	2,560	5,044	611	2,110
60"	216"	<b>02R60X216</b>	45,634	48,136	2,560	2,560	5,274	611	2,110
60"	228"	<b>02R60X228</b>	47,535	50,175	2,560	2,560	5,503	611	2,110
60"	240"	<b>02R60X240</b>	49,464	52,242	2,560	2,560	5,732	611	2,110

Order Code	Specification Information	Refer To Accessories Section	Pricing Tiers
Example: <b>02R60X96-GE01-PM01-MC01-GM2-MC01-UCO</b>	<b>To order please specify pattern number including:</b>	Please refer to Accessories section, <b>page 213</b> for power details.	Please refer to Materials and Finish <b>page 9</b> for specification details.
<b>02</b> Highline Collection	1. Top finish	<b>Grommet options available in these finishes:</b>	T1 and T2 pricing includes powder coated base finish.
<b>R</b> Rectangular	2. Trim Finish (only applies if trim type is metal or leather)	Powder coated	There is an upcharge for plated base finishes as highlighted above.
<b>60</b> Depth	3. Base finish	Premium (Polished Chrome, Satin Nickel or Oil Rubbed Bronze)	For additional stone options and pricing please contact your sales representative."
<b>96</b> Width	4. Grommet option	<b>Power Box Options</b>	
<b>GE01</b> Top Finish	5. Grommet finish (only applies if grommets are selected)	<b>Code: Description:</b>	
<b>PM01</b> Trim Finish	6. Power box option	NP No Power	
<b>MC01</b> Base Finish	7. Table-top power finish (only applies if table-top power is selected)	UCO Undermount	
<b>GM2</b> Grommet Opt.	<b>Trim Type</b>	ECO Edgemount	
<b>MC01</b> Grommet Finish	N = No trim	T1E Tabletop 1-Sided Lid	
<b>UCO</b> Undermount	M = Metal (available in Premium and Powder Coat finishes)	T2C Tabletop 2-Sided Lid	
	L = Leather	<b>Must select Wire Management Column and Finish:</b>	
		Powder coated	
		Premium (Polished Chrome, Satin Nickel or Oil Rubbed Bronze)	

# Rectangular Conference Tables

**60" Deep Tops**  
**Corian Top**

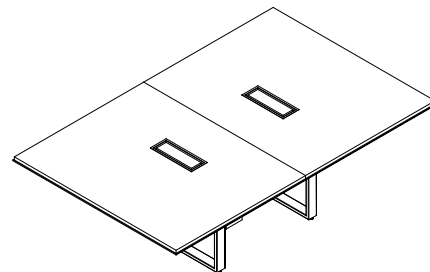

D	W	Pattern No.	CS01 Top	PM01/PM02 Edge Upcharge	PM03 Edge Upcharge	AU__ Edge Upcharge	PM01/PM02 Base Upcharge	PM03 Base Upcharge
60"	96"	<b>02R60X96</b>	\$23,957	\$1,519	\$1,519	\$2,981	\$408	\$1,408
60"	108"	<b>02R60X108</b>	26,176	1,519	1,519	3,210	408	1,408
60"	120"	<b>02R60X120</b>	28,312	1,519	1,519	3,439	408	1,408
60"	132"	<b>02R60X132</b>	32,814	1,731	1,731	3,669	408	1,408
60"	144"	<b>02R60X144</b>	36,081	1,731	1,731	3,899	611	2,110
60"	156"	<b>02R60X156</b>	38,053	1,731	1,731	4,128	611	2,110
60"	168"	<b>02R60X168</b>	40,669	2,560	2,560	4,356	611	2,110
60"	180"	<b>02R60X180</b>	42,752	2,560	2,560	4,587	611	2,110
60"	192"	<b>02R60X192</b>	45,011	2,560	2,560	4,816	611	2,110
60"	204"	<b>02R60X204</b>	47,246	2,560	2,560	5,044	611	2,110
60"	216"	<b>02R60X216</b>	49,305	2,560	2,560	5,274	611	2,110
60"	228"	<b>02R60X228</b>	51,434	2,560	2,560	5,503	611	2,110
60"	240"	<b>02R60X240</b>	53,591	2,560	2,560	5,732	611	2,110

Order Code	Specification Information	Refer To Accessories Section	Pricing Tiers
Example: <b>02R60X96-CS01-PM01-MC01-GM2-MC01-UCO</b>	<b>To order please specify pattern number including:</b>	Please refer to Accessories section, <b>page 213</b> for power details.	Please refer to Materials and Finish <b>page 9</b> for specification details.
<b>02</b> Highline Collection	1. Top finish	<b>Grommet options available in these finishes:</b>	T1 and T2 pricing includes powder coated base finish.
<b>R</b> Rectangular	2. Trim Finish (only applies if trim type is metal or leather)	Powder coated	There is an upcharge for plated base finishes as highlighted above.
<b>60</b> Depth	3. Base finish	Premium (Polished Chrome, Satin Nickel or Oil Rubbed Bronze)	For additional stone options and pricing please contact your sales representative."
<b>96</b> Width	4. Grommet option	<b>Power Box Options</b>	
<b>CS01</b> Top Finish	5. Grommet finish (only applies if grommets are selected)	<b>Code: Description:</b>	
<b>PM01</b> Trim Finish	6. Power box option	NP No Power	
<b>MC01</b> Base Finish	7. Table-top power finish (only applies if table-top power is selected)	UCO Undermount	
<b>GM2</b> Grommet Opt.	<b>Trim Type</b>	ECO Edgemount	
<b>MC01</b> Grommet Finish	N = No trim	T1E Tabletop 1-Sided Lid	
<b>UCO</b> Undermount	M = Metal (available in Premium and Powder Coat finishes)	T2C Tabletop 2-Sided Lid	
	L = Leather	<b>Must select Wire Management Column and Finish:</b>	
		Powder coated	
		Premium (Polished Chrome, Satin Nickel or Oil Rubbed Bronze)	



# Rectangular Conference Tables

## 72" Deep Tops

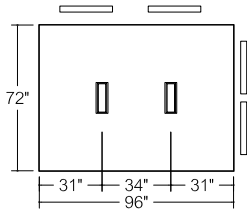
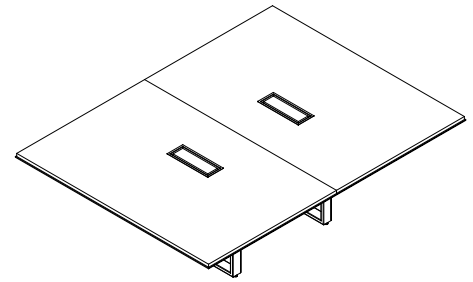

**02R72X96**  
8 Person Table

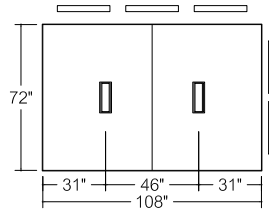

**02R72X108**  
10 Person Table

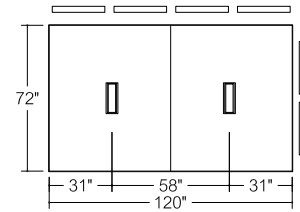

**02R72X120**  
12 Person Table

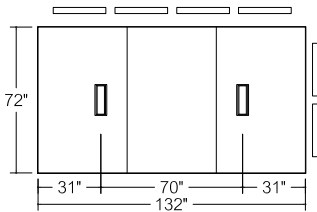

**02R72X132**  
12 Person Table

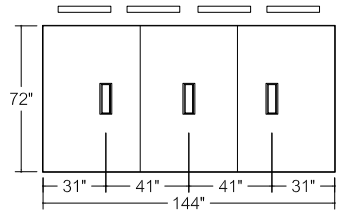

**02R72X144**  
12 Person Table

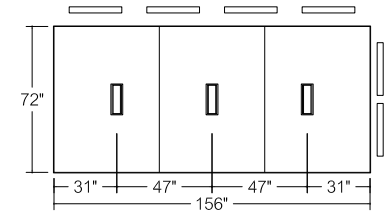

**02R72X156**  
12 Person Table

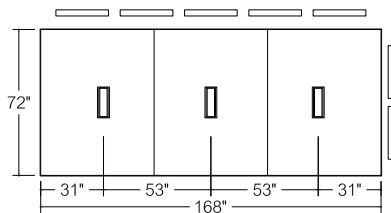

**02R72X168**  
14 Person Table

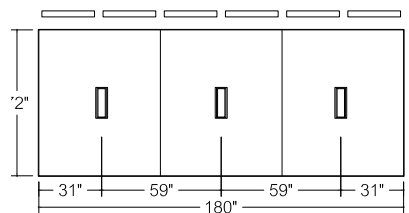

**02R72X180**  
16 Person Table

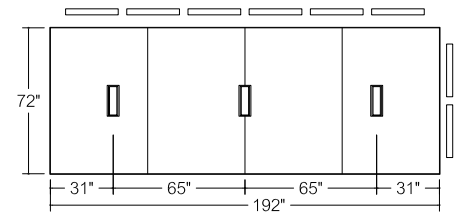

**02R72X192**  
16 Person Table

# Rectangular Conference Tables

**72" Deep Tops**

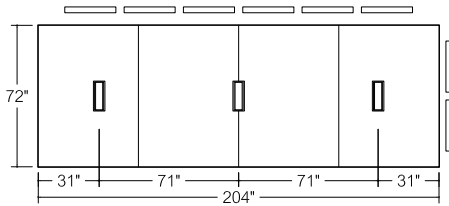
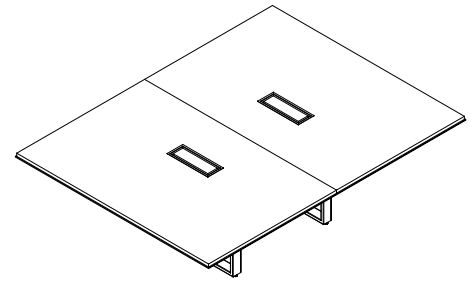

**02R72X204**

16 Person Table

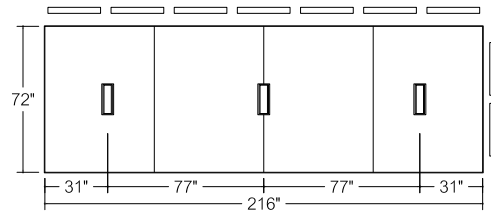

**02R72X216**

18 Person Table

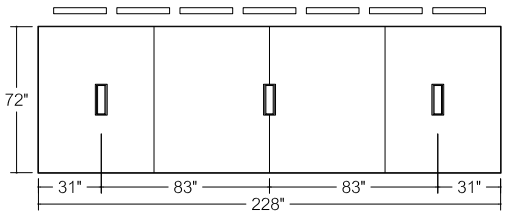

**02R72X228**

18 Person Table

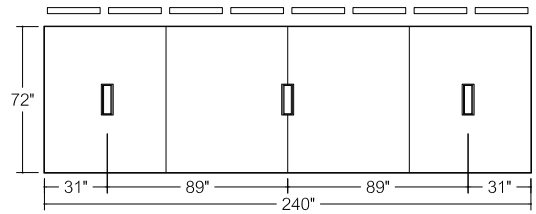

**02R72X240**

20 Person Table

# Rectangular Conference Tables

**72" Deep Tops**  
**Veneer Top**

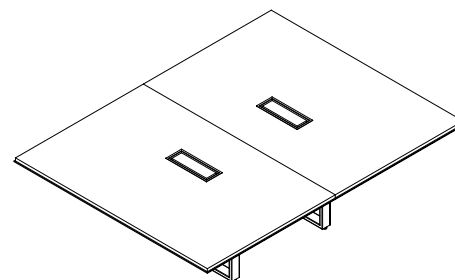

D	W	Pattern No.	T1__ Top	T2__ Top	PM01/ PM02 Edge Upcharge	PM03 Edge Upcharge	AU__ Edge Upcharge	PM01/ PM02 Base Upcharge	PM03 Base Upcharge
72"	96"	<b>02R72X96</b>	\$18,972	\$20,443	\$1,634	\$1,634	\$3,210	\$408	\$1,408
72"	108"	<b>02R72X108</b>	20,456	22,112	1,634	1,634	3,439	408	1,408
72"	120"	<b>02R72X120</b>	21,868	23,708	1,634	1,634	3,669	408	1,408
72"	132"	<b>02R72X132</b>	25,388	27,413	1,731	1,731	3,899	408	1,408
72"	144"	<b>02R72X144</b>	27,246	29,453	1,731	1,731	4,128	611	2,110
72"	156"	<b>02R72X156</b>	28,955	31,346	1,731	1,731	4,356	611	2,110
72"	168"	<b>02R72X168</b>	30,380	32,956	2,560	2,560	4,587	644	3,028
72"	180"	<b>02R72X180</b>	31,748	34,507	2,560	2,560	4,816	644	3,028
72"	192"	<b>02R72X192</b>	33,222	36,165	2,560	2,560	5,044	644	3,028
72"	204"	<b>02R72X204</b>	34,630	37,756	2,560	2,560	5,274	644	3,028
72"	216"	<b>02R72X216</b>	36,047	39,357	2,560	2,560	5,503	644	3,028
72"	228"	<b>02R72X228</b>	37,432	40,928	2,560	2,560	5,732	644	3,028
72"	240"	<b>02R72X240</b>	38,824	42,503	2,560	2,560	5,962	644	3,028

Order Code	Specification Information	Refer To Accessories Section	Pricing Tiers
Example: <b>02R72X96-T003-PM01-MC01-GM2-MC01-UCO</b>	<b>To order please specify pattern number including:</b>	Please refer to Accessories section, <b>page 213</b> for power details.	Please refer to Materials and Finish <b>page 9</b> for specification details.
<b>02</b> Highline Collection	1. Top finish	<b>Grommet options available in these finishes:</b>	T1 and T2 pricing includes powder coated base finish.
<b>R</b> Rectangular	2. Trim Finish (only applies if trim type is metal or leather)	Powder coated	There is an upcharge for plated base finishes as highlighted above.
<b>72</b> Depth	3. Base finish	Premium (Polished Chrome, Satin Nickel or Oil Rubbed Bronze)	For additional stone options and pricing please contact your sales representative."
<b>96</b> Width	4. Grommet option	<b>Power Box Options</b>	
<b>T003</b> Top Finish	5. Grommet finish (only applies if grommets are selected)	<b>Code: Description:</b>	
<b>PM01</b> Trim Finish	6. Power box option	NP No Power	
<b>MC01</b> Base Finish	7. Table-top power finish (only applies if table-top power is selected)	UCO Undermount	
<b>GM2</b> Grommet Opt.	<b>Trim Type</b>	ECO Edgemount	
<b>MC01</b> Grommet Finish	N = No trim	T1E Tabletop 1-Sided Lid	
<b>UCO</b> Undermount	M = Metal (available in Premium and Powder Coat finishes)	T2C Tabletop 2-Sided Lid	
	L = Leather	<b>Must select Wire Management Column and Finish:</b>	
		Powder coated	
		Premium (Polished Chrome, Satin Nickel or Oil Rubbed Bronze)	

# Rectangular Conference Tables

**72" Deep Tops**  
**Glass Top**

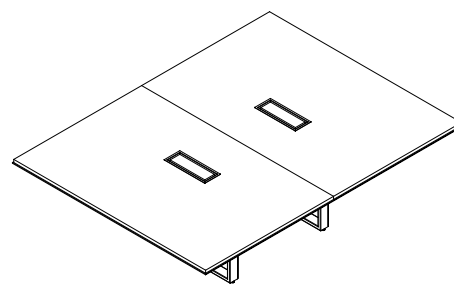

D	W	Pattern No.	GC__ Top	GE__ Top	PM01/ PM02 Edge Upcharge	PM03 Edge Upcharge	AU__ Edge Upcharge	PM01/ PM02 Base Upcharge	PM03 Base Upcharge
72"	96"	<b>02R72X96</b>	\$26,375	\$27,709	\$1,634	\$1,634	\$3,210	\$408	\$1,408
72"	108"	<b>02R72X108</b>	28,748	30,249	1,634	1,634	3,439	408	1,408
72"	120"	<b>02R72X120</b>	31,045	32,711	1,634	1,634	3,669	408	1,408
72"	132"	<b>02R72X132</b>	35,540	37,373	1,731	1,731	3,899	408	1,408
72"	144"	<b>02R72X144</b>	38,299	40,300	1,731	1,731	4,128	611	2,110
72"	156"	<b>02R72X156</b>	40,907	43,075	1,731	1,731	4,356	611	2,110
72"	168"	<b>02R72X168</b>	43,216	45,550	2,560	2,560	4,587	644	3,028
72"	180"	<b>02R72X180</b>	45,468	47,969	2,560	2,560	4,816	644	3,028
72"	192"	<b>02R72X192</b>	47,829	50,498	2,560	2,560	5,044	644	3,028
72"	204"	<b>02R72X204</b>	50,122	52,957	2,560	2,560	5,274	644	3,028
72"	216"	<b>02R72X216</b>	52,424	55,549	2,560	2,560	5,503	644	3,028
72"	228"	<b>02R72X228</b>	54,694	57,863	2,560	2,560	5,732	644	3,028
72"	240"	<b>02R72X240</b>	56,971	60,304	2,560	2,560	5,962	644	3,028

Order Code	Specification Information	Refer To Accessories Section	Pricing Tiers
Example: <b>02R72X96-GE01-PM01-MC01-GM2-MC01-UCO</b>	<b>To order please specify pattern number including:</b>	Please refer to Accessories section, <b>page 213</b> for power details.	Please refer to Materials and Finish <b>page 9</b> for specification details.
<b>02</b> Highline Collection	1. Top finish	<b>Grommet options available in these finishes:</b>	T1 and T2 pricing includes powder coated base finish.
<b>R</b> Rectangular	2. Trim Finish (only applies if trim type is metal or leather)	Powder coated	There is an upcharge for plated base finishes as highlighted above.
<b>72</b> Depth	3. Base finish	Premium (Polished Chrome, Satin Nickel or Oil Rubbed Bronze)	For additional stone options and pricing please contact your sales representative."
<b>96</b> Width	4. Grommet option	<b>Power Box Options</b>	
<b>GE01</b> Top Finish	5. Grommet finish (only applies if grommets are selected)	<b>Code: Description:</b>	
<b>PM01</b> Trim Finish	6. Power box option	NP No Power	
<b>MC01</b> Base Finish	7. Table-top power finish (only applies if table-top power is selected)	UCO Undermount	
<b>GM2</b> Grommet Opt.	<b>Trim Type</b>	ECO Edgemount	
<b>MC01</b> Grommet Finish	N = No trim	T1E Tabletop 1-Sided Lid	
<b>UCO</b> Undermount	M = Metal (available in Premium and Powder Coat finishes)	T2C Tabletop 2-Sided Lid	
	L = Leather	<b>Must select Wire Management Column and Finish:</b>	
		Powder coated	
		Premium (Polished Chrome, Satin Nickel or Oil Rubbed Bronze)	

# Rectangular Conference Tables

**72" Deep Tops**  
**Corian Top**

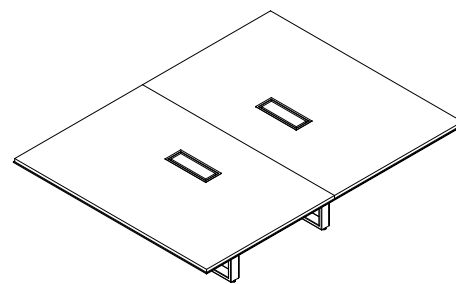

D	W	Pattern No.	CS01 Top	PM01/ PM02 Edge Upcharge	PM03 Edge Upcharge	AU__ Edge Upcharge	PM01/ PM02 Base Upcharge	PM03 Base Upcharge
72"	96"	<b>02R72X96</b>	\$28,250	\$1,634	\$1,634	\$3,210	\$408	\$1,408
72"	108"	<b>02R72X108</b>	30,894	1,634	1,634	3,439	408	1,408
72"	120"	<b>02R72X120</b>	33,465	1,634	1,634	3,669	408	1,408
72"	132"	<b>02R72X132</b>	38,146	1,731	1,731	3,899	408	1,408
72"	144"	<b>02R72X144</b>	41,162	1,731	1,731	4,128	611	2,110
72"	156"	<b>02R72X156</b>	44,032	1,731	1,731	4,356	611	2,110
72"	168"	<b>02R72X168</b>	46,617	2,560	2,560	4,587	644	3,028
72"	180"	<b>02R72X180</b>	49,144	2,560	2,560	4,816	644	3,028
72"	192"	<b>02R72X192</b>	51,778	2,560	2,560	5,044	644	3,028
72"	204"	<b>02R72X204</b>	54,343	2,560	2,560	5,274	644	3,028
72"	216"	<b>02R72X216</b>	56,921	2,560	2,560	5,503	644	3,028
72"	228"	<b>02R72X228</b>	59,469	2,560	2,560	5,732	644	3,028
72"	240"	<b>02R72X240</b>	62,152	2,560	2,560	5,962	644	3,028

Order Code	Specification Information	Refer To Accessories Section	Pricing Tiers
Example: <b>02R72X96-CS01-PM01-MC01-GM2-MC01-UCO</b>	<b>To order please specify pattern number including:</b>	Please refer to Accessories section, <b>page 213</b> for power details.	Please refer to Materials and Finish <b>page 9</b> for specification details.
<b>02</b> Highline Collection	1. Top finish	<b>Grommet options available in these finishes:</b>	T1 and T2 pricing includes powder coated base finish.
<b>R</b> Rectangular	2. Trim Finish (only applies if trim type is metal or leather)	Powder coated	There is an upcharge for plated base finishes as highlighted above.
<b>72</b> Depth	3. Base finish	Premium (Polished Chrome, Satin Nickel or Oil Rubbed Bronze)	For additional stone options and pricing please contact your sales representative."
<b>96</b> Width	4. Grommet option	<b>Power Box Options</b>	
<b>CS01</b> Top Finish	5. Grommet finish (only applies if grommets are selected)	<b>Code: Description:</b>	
<b>PM01</b> Trim Finish	6. Power box option	NP No Power	
<b>MC01</b> Base Finish	7. Table-top power finish (only applies if table-top power is selected)	UCO Undermount	
<b>GM2</b> Grommet Opt.	<b>Trim Type</b>	ECO Edgemount	
<b>MC01</b> Grommet Finish	N = No trim	T1E Tabletop 1-Sided Lid	
<b>UCO</b> Undermount	M = Metal (available in Premium and Powder Coat finishes)	T2C Tabletop 2-Sided Lid	
	L = Leather	<b>Must select Wire Management Column and Finish:</b>	
		Powder coated	
		Premium (Polished Chrome, Satin Nickel or Oil Rubbed Bronze)	





# Elliptical Conference Tables

48"-72" Deep Tops

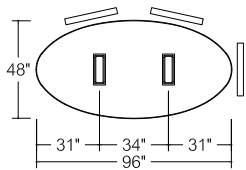
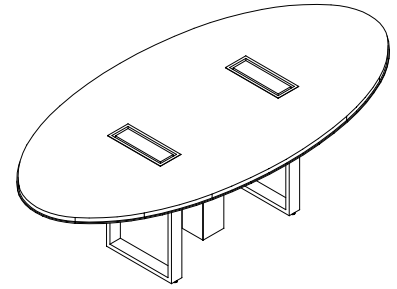

**02E48X96**  
6 Person Table

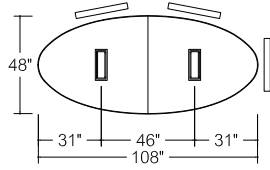

**02E48X108**  
6 Person Table

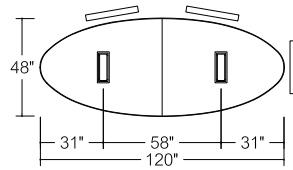

**02E48X120**  
6 Person Table

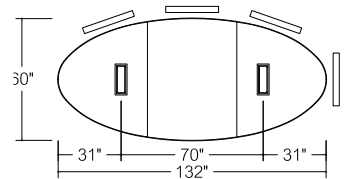

**02E60X132**  
8 Person Table

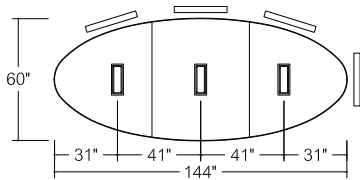

**02E60X144**  
8 Person Table

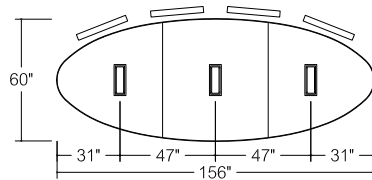

**02E60X156**  
8 Person Table

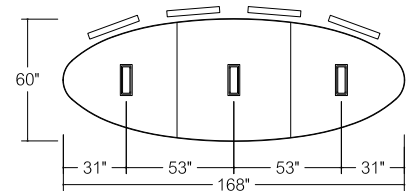

**02E60X168**  
8 Person Table

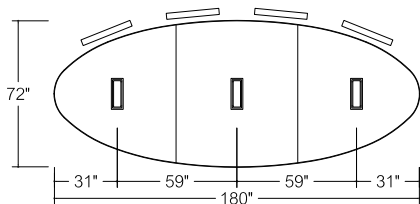

**02E72X180**  
8 Person Table

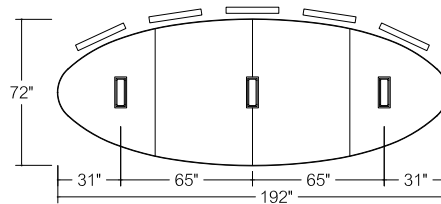

**02E72X192**  
10 Person Table

# Elliptical Conference Tables

**48"-72" Deep Tops**

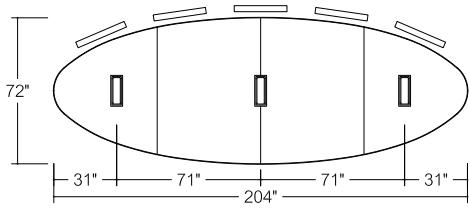
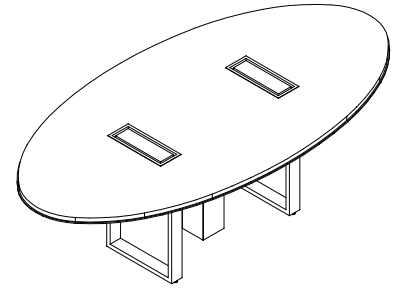

**02E72X204**  
10 Person Table

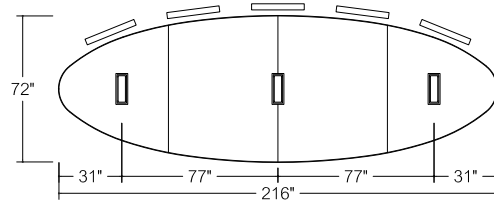

**02E72X216**  
10 Person Table

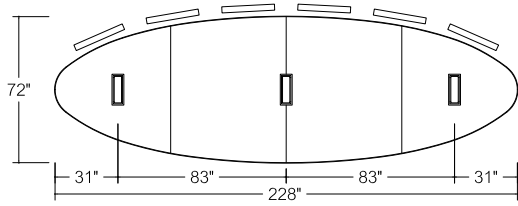

**02E72X228**  
12 Person Table

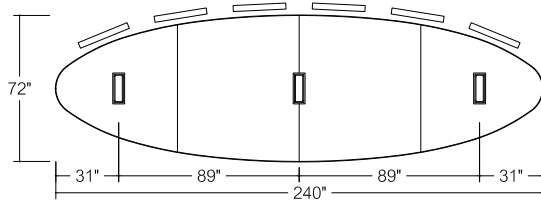

**02E72X240**  
12 Person Table

# Elliptical Conference Tables

## 48"-72" Deep Elliptical Tops

### Veneer Top

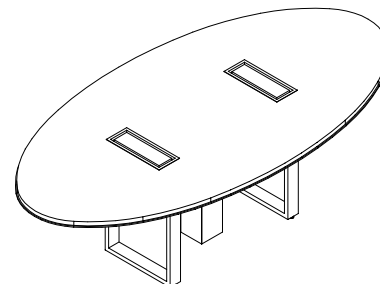

D	W	Pattern No.	T1__Top	T2__Top	PM01/ PM02 Edge Upcharge	PM03 Edge Upcharge	AU__ Edge Upcharge	PM01/ PM02 Base Upcharge	PM03 Base Upcharge
48"	96"	<b>02E48X96</b>	\$19,446	\$20,429	\$1,983	\$4,419	\$2,808	\$429	\$841
48"	108"	<b>02E48X108</b>	20,076	21,180	1,983	5,071	3,068	429	841
48"	120"	<b>02E48X120</b>	21,399	22,625	2,007	5,016	3,331	429	841
60"	132"	<b>02E60X132</b>	25,584	27,271	2,378	6,082	3,764	429	841
60"	144"	<b>02E60X144</b>	28,064	29,905	2,378	6,082	4,028	644	1,260
60"	156"	<b>02E60X156</b>	29,061	31,054	2,379	6,083	4,293	644	1,260
60"	168"	<b>02E60X168</b>	31,091	33,238	2,418	6,083	4,559	644	1,260
72"	180"	<b>02E72X180</b>	36,703	39,460	2,485	6,154	4,986	634	1,544
72"	192"	<b>02E72X192</b>	39,160	42,103	3,015	7,902	5,253	634	1,544
72"	204"	<b>02E72X204</b>	40,468	43,595	3,015	7,902	5,521	634	1,544
72"	216"	<b>02E72X216</b>	42,567	45,878	3,015	7,902	5,788	634	1,544
72"	228"	<b>02E72X228</b>	43,262	46,756	3,068	7,954	6,060	634	1,544
72"	240"	<b>02E72X240</b>	46,040	49,719	3,068	7,954	6,331	634	1,544

Order Code	Specification Information	Refer To Accessories Section	Pricing Tiers
Example: <b>02E48X96-T003-PM01-MC01-GM2-MC01-UCO</b>	<b>To order please specify pattern number including:</b>	Please refer to Accessories section, <b>page 213</b> for power details.	Please refer to Materials and Finish <b>page 9</b> for specification details.
<b>02</b> Highline Collection	1. Top finish	<b>Grommet options available in these finishes:</b>	T1 and T2 pricing includes powder coated base finish.
<b>E</b> Elliptical	2. Trim Finish (only applies if trim type is metal or leather)	Powder coated	There is an upcharge for plated base finishes as highlighted above.
<b>48</b> Depth	3. Base finish	Premium (Polished Chrome, Satin Nickel or Oil Rubbed Bronze)	For additional stone options and pricing please contact your sales representative."
<b>96</b> Width	4. Grommet option	<b>Power Box Options</b>	
<b>T003</b> Top Finish	5. Grommet finish (only applies if grommets are selected)	<b>Code: Description:</b>	
<b>PM01</b> Trim Finish	6. Power box option	NP No Power	
<b>MC01</b> Base Finish	7. Table-top power finish (only applies if table-top power is selected)	UCO Undermount	
<b>GM2</b> Grommet Opt.	<b>Trim Type</b>	ECO Edgemount	
<b>MC01</b> Grommet Finish	N = No trim	T1E Tabletop 1-Sided Lid	
<b>UCO</b> Undermount	M = Metal (available in Premium and Powder Coat finishes)	T2C Tabletop 2-Sided Lid	
	L = Leather	<b>Must select Wire Management Column and Finish:</b>	
		Powder coated	
		Premium (Polished Chrome, Satin Nickel or Oil Rubbed Bronze)	

# Elliptical Conference Tables

## 48"-72" Deep Elliptical Tops

### Glass Top

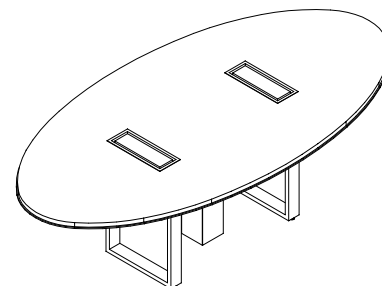

D	W	Pattern No.	GC__ Top	GE__ Top	PM01/ PM02 Edge Upcharge	PM03 Edge Upcharge	AU__ Edge Upcharge	PM01/ PM02 Base Upcharge	PM03 Base Upcharge
48"	96"	<b>02E48X96</b>	\$26,937	\$28,271	\$1,983	\$4,419	\$2,808	\$429	\$841
48"	108"	<b>02E48X108</b>	28,427	29,927	1,983	5,071	3,068	429	841
48"	120"	<b>02E48X120</b>	30,641	32,306	2,007	5,016	3,331	429	841
60"	132"	<b>02E60X132</b>	38,128	40,420	2,378	6,082	3,764	429	841
60"	144"	<b>02E60X144</b>	41,754	44,255	2,378	6,082	4,028	644	1,260
60"	156"	<b>02E60X156</b>	43,834	46,545	2,379	6,083	4,293	644	1,260
60"	168"	<b>02E60X168</b>	46,993	49,911	2,418	6,083	4,559	644	1,260
72"	180"	<b>02E72X180</b>	57,008	60,761	2,485	6,154	4,986	634	1,544
72"	192"	<b>02E72X192</b>	60,822	64,826	3,015	7,902	5,253	634	1,544
72"	204"	<b>02E72X204</b>	63,434	67,687	3,015	7,902	5,521	634	1,544
72"	216"	<b>02E72X216</b>	66,874	71,375	3,015	7,902	5,788	634	1,544
72"	228"	<b>02E72X228</b>	68,847	73,598	3,068	7,954	6,060	634	1,544
72"	240"	<b>02E72X240</b>	72,993	77,995	3,068	7,954	6,331	634	1,544

Order Code	Specification Information	Refer To Accessories Section	Pricing Tiers
Example: <b>02E48X96-GE01-PM01-MC01-GM2-MC01-UCO</b>	<b>To order please specify pattern number including:</b>	Please refer to Accessories section, <b>page 213</b> for power details.	Please refer to Materials and Finish <b>page 9</b> for specification details.
<b>02</b> Highline Collection	1. Top finish	<b>Grommet options available in these finishes:</b>	T1 and T2 pricing includes powder coated base finish.
<b>E</b> Elliptical	2. Trim Finish (only applies if trim type is metal or leather)	Powder coated	There is an upcharge for plated base finishes as highlighted above.
<b>48</b> Depth	3. Base finish	Premium (Polished Chrome, Satin Nickel or Oil Rubbed Bronze)	For additional stone options and pricing please contact your sales representative."
<b>96</b> Width	4. Grommet option	<b>Power Box Options</b>	
<b>GE01</b> Top Finish	5. Grommet finish (only applies if grommets are selected)	<b>Code: Description:</b>	
<b>PM01</b> Trim Finish	6. Power box option	NP No Power	
<b>MC01</b> Base Finish	7. Table-top power finish (only applies if table-top power is selected)	UCO Undermount	
<b>GM2</b> Grommet Opt.	<b>Trim Type</b>	ECO Edgemount	
<b>MC01</b> Grommet Finish	N = No trim	T1E Tabletop 1-Sided Lid	
<b>UCO</b> Undermount	M = Metal (available in Premium and Powder Coat finishes)	T2C Tabletop 2-Sided Lid	
	L = Leather	<b>Must select Wire Management Column and Finish:</b>	
		Powder coated	
		Premium (Polished Chrome, Satin Nickel or Oil Rubbed Bronze)	

# Elliptical Conference Tables

## 48"-72" Deep Elliptical Tops

### Corian Top

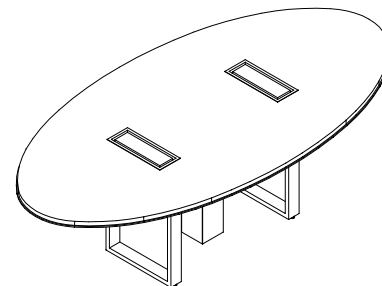

D	W	Pattern No.	CS01 Top	PM01/ PM02 Edge Upcharge	PM03 Edge Upcharge	AU__ Edge Upcharge	PM01/ PM02 Base Upcharge	PM03 Base Upcharge
48"	96"	<b>02E48X96</b>	\$29,685	\$1,983	\$4,419	\$2,808	\$429	\$841
48"	108"	<b>02E48X108</b>	31,593	1,983	5,071	3,068	429	841
48"	120"	<b>02E48X120</b>	34,196	2,007	5,016	3,331	429	841
60"	132"	<b>02E60X132</b>	43,181	2,378	6,082	3,764	429	841
60"	144"	<b>02E60X144</b>	47,260	2,378	6,082	4,028	644	1,260
60"	156"	<b>02E60X156</b>	49,856	2,379	6,083	4,293	644	1,260
60"	168"	<b>02E60X168</b>	53,486	2,418	6,083	4,559	644	1,260
72"	180"	<b>02E72X180</b>	65,496	2,485	6,154	4,986	634	1,544
72"	192"	<b>02E72X192</b>	69,874	3,015	7,902	5,253	634	1,544
72"	204"	<b>02E72X204</b>	73,100	3,015	7,902	5,521	634	1,544
72"	216"	<b>02E72X216</b>	77,119	3,015	7,902	5,788	634	1,544
72"	228"	<b>02E72X228</b>	79,732	3,068	7,954	6,060	634	1,544
72"	240"	<b>02E72X240</b>	84,430	3,068	7,954	6,331	634	1,544

Order Code	Specification Information	Refer To Accessories Section	Pricing Tiers
Example: <b>02E48X96-CS01-PM01-MC01-GM2-MC01-UCO</b>	<b>To order please specify pattern number including:</b>	Please refer to Accessories section, <b>page 213</b> for power details.	Please refer to Materials and Finish <b>page 9</b> for specification details.
<b>02</b> Highline Collection	1. Top finish	<b>Grommet options available in these finishes:</b>	T1 and T2 pricing includes powder coated base finish.
<b>E</b> Elliptical	2. Trim Finish (only applies if trim type is metal or leather)	Powder coated	There is an upcharge for plated base finishes as highlighted above.
<b>48</b> Depth	3. Base finish	Premium (Polished Chrome, Satin Nickel or Oil Rubbed Bronze)	For additional stone options and pricing please contact your sales representative."
<b>96</b> Width	4. Grommet option	<b>Power Box Options</b>	
<b>CS01</b> Top Finish	5. Grommet finish (only applies if grommets are selected)	<b>Code: Description:</b>	
<b>PM01</b> Trim Finish	6. Power box option	NP No Power	
<b>MC01</b> Base Finish	7. Table-top power finish (only applies if table-top power is selected)	UCO Undermount	
<b>GM2</b> Grommet Opt.	<b>Trim Type</b>	ECO Edgemount	
<b>MC01</b> Grommet Finish	N = No trim	T1E Tabletop 1-Sided Lid	
<b>UCO</b> Undermount	M = Metal (available in Premium and Powder Coat finishes)	T2C Tabletop 2-Sided Lid	
	L = Leather	<b>Must select Wire Management Column and Finish:</b>	
		Powder coated	
		Premium (Polished Chrome, Satin Nickel or Oil Rubbed Bronze)	



# Boat Conference Tables

## 48"-72" Deep Tops

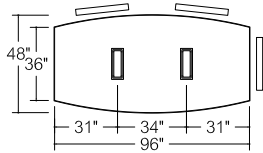
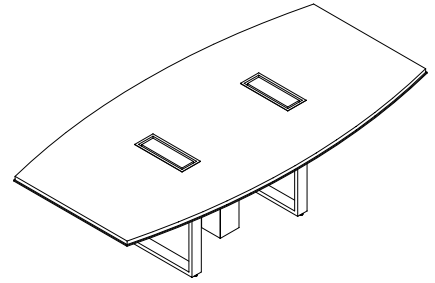

**O2B48X96**  
6 Person Table

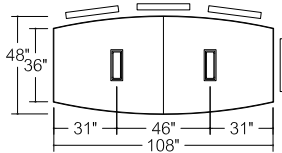

**O2B48X108**  
8 Person Table

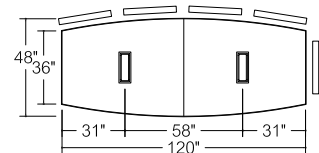

**O2B48X120**  
10 Person Table

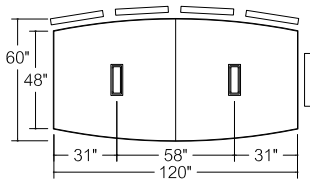

**O2B60X120**  
10 Person Table

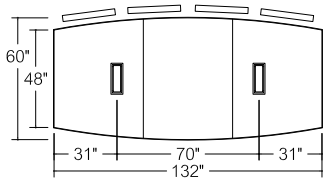

**O2B60X132**  
10 Person Table

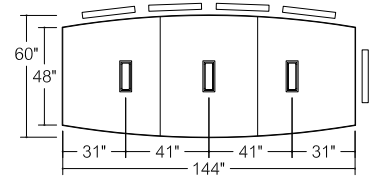

**O2B60X144**  
10 Person Table

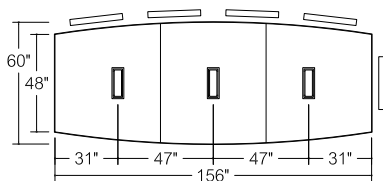

**O2B60X156**  
10 Person Table

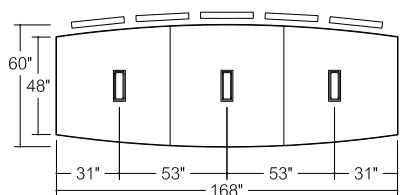

**O2B60X168**  
12 Person Table



# Boat Conference Tables

## 48"-72" Deep Tops

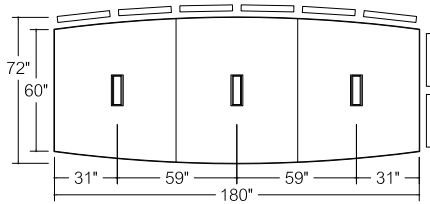
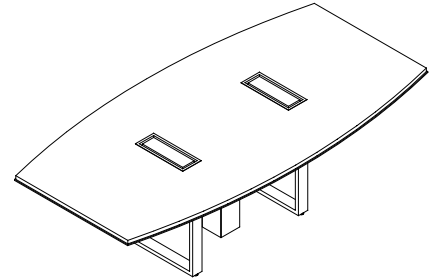

**02B72X180**  
16 Person Table

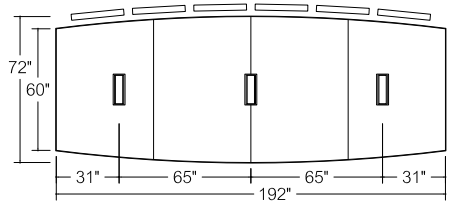

**02B72X192**  
16 Person Table

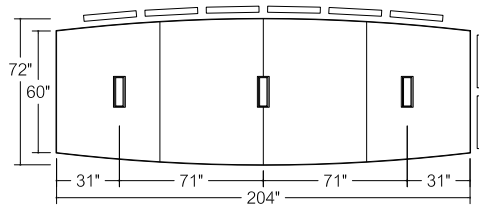

**02B72X204**  
16 Person Table

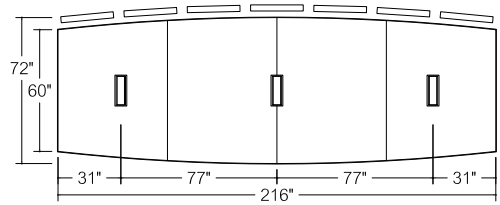

**02B72X216**  
18 Person Table

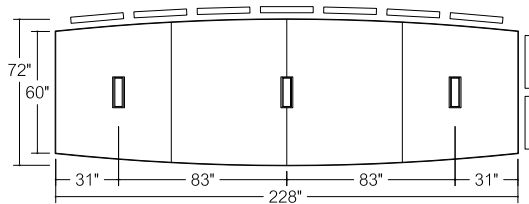

**02B72X228**  
18 Person Table

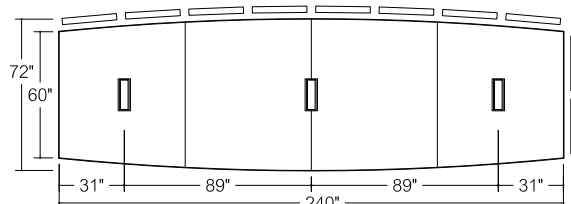

**02B72X240**  
20 Person Table

# Boat Conference Tables

## 48"-72" Deep Boat Tops

### Veneer Top

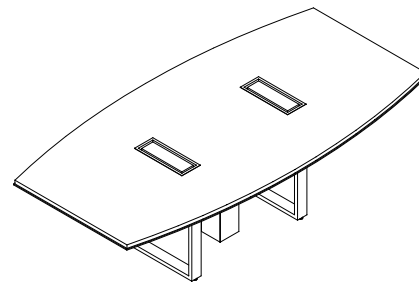

D	W	Pattern No.	T1__ Top	T2__ Top	PM01/ PM02 Edge Upcharge	PM03 Edge Upcharge	AU__ Edge Upcharge	PM01/ PM02 Base Upcharge	PM03 Base Upcharge
48"	96"	<b>02B48X96</b>	\$20,822	\$21,803	\$2,403	\$6,082	\$3,216	\$429	\$841
48"	108"	<b>02B48X108</b>	21,436	22,542	2,403	6,083	3,502	429	841
48"	120"	<b>02B48X120</b>	22,772	23,998	2,413	6,095	3,786	429	841
60"	120"	<b>02B60X120</b>	23,034	24,569	2,413	6,095	4,074	408	1,408
60"	132"	<b>02B60X132</b>	27,056	28,741	3,250	8,110	4,361	408	1,408
60"	144"	<b>02B60X144</b>	30,286	32,125	3,171	8,110	4,647	611	2,110
60"	156"	<b>02B60X156</b>	31,284	33,278	3,170	8,109	4,933	611	2,110
72"	168"	<b>02B60X168</b>	33,314	35,460	3,210	8,110	5,222	611	2,110
72"	180"	<b>02B72X180</b>	39,717	42,476	3,223	8,110	5,794	611	2,110
72"	192"	<b>02B72X192</b>	41,927	44,870	3,782	9,892	6,083	611	2,110
72"	204"	<b>02B72X204</b>	43,222	46,350	3,782	9,892	6,370	611	2,110
72"	216"	<b>02B72X216</b>	45,321	48,631	3,782	9,944	6,657	611	2,110
72"	228"	<b>02B72X228</b>	46,014	49,510	3,835	9,944	6,942	611	2,110
72"	240"	<b>02B72X240</b>	48,793	52,500	3,835	9,944	7,232	611	2,110

Order Code	Specification Information	Refer To Accessories Section	Pricing Tiers
Example: <b>02B48X96-T003-PM01-MC01-GM2-MC01-UCO</b>	<b>To order please specify pattern number including:</b>	Please refer to Accessories section, <b>page 213</b> for power details.	Please refer to Materials and Finish <b>page 9</b> for specification details.
<b>02</b> Highline Collection	1. Top finish	<b>Grommet options available in these finishes:</b>	T1 and T2 pricing includes powder coated base finish.
<b>B</b> Boat Shaped	2. Trim Finish (only applies if trim type is metal or leather)	Powder coated	There is an upcharge for plated base finishes as highlighted above.
<b>48</b> Depth	3. Base finish	Premium (Polished Chrome, Satin Nickel or Oil Rubbed Bronze)	For additional stone options and pricing please contact your sales representative."
<b>96</b> Width	4. Grommet option	<b>Power Box Options</b>	
<b>T003</b> Top Finish	5. Grommet finish (only applies if grommets are selected)	<b>Code: Description:</b>	
<b>PM01</b> Trim Finish	6. Power box option	NP No Power	
<b>MC01</b> Base Finish	7. Table-top power finish (only applies if table-top power is selected)	UCO Undermount	
<b>GM2</b> Grommet Opt.	<b>Trim Type</b>	ECO Edgemount	
<b>MC01</b> Grommet Finish	N = No trim	T1E Tabletop 1-Sided Lid	
<b>UCO</b> Undermount	M = Metal (available in Premium and Powder Coat finishes)	T2C Tabletop 2-Sided Lid	
	L = Leather	<b>Must select Wire Management Column and Finish:</b>	
		Powder coated	
		Premium (Polished Chrome, Satin Nickel or Oil Rubbed Bronze)	

# Boat Conference Tables

## 48"-72" Deep Boat Tops

### Glass Top

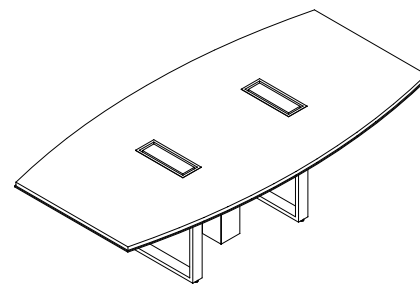

D	W	Pattern No.	GC__ Top	GE__ Top	PM01/ PM02 Edge Upcharge	PM03 Edge Upcharge	AU__ Edge Upcharge	PM01/ PM02 Base Upcharge	PM03 Base Upcharge
48"	96"	<b>02B48X96</b>	\$28,370	\$29,704	\$2,403	\$6,082	\$3,216	\$429	\$841
48"	108"	<b>02B48X108</b>	29,845	31,346	2,403	6,083	3,502	429	841
48"	120"	<b>02B48X120</b>	32,072	33,739	2,413	6,095	3,786	429	841
60"	120"	<b>02B60X120</b>	34,428	36,512	2,413	6,095	4,074	408	1,408
60"	132"	<b>02B60X132</b>	39,660	41,953	3,250	8,110	4,361	408	1,408
60"	144"	<b>02B60X144</b>	44,069	46,571	3,171	8,110	4,647	611	2,110
60"	156"	<b>02B60X156</b>	46,153	48,861	3,170	8,109	4,933	611	2,110
72"	168"	<b>02B60X168</b>	49,309	52,228	3,210	8,110	5,222	611	2,110
72"	180"	<b>02B72X180</b>	60,153	63,903	3,223	8,110	5,794	611	2,110
72"	192"	<b>02B72X192</b>	63,706	67,708	3,782	9,892	6,083	611	2,110
72"	204"	<b>02B72X204</b>	66,305	70,556	3,782	9,892	6,370	611	2,110
72"	216"	<b>02B72X216</b>	69,743	74,246	3,782	9,944	6,657	611	2,110
72"	228"	<b>02B72X228</b>	71,716	76,469	3,835	9,944	6,942	611	2,110
72"	240"	<b>02B72X240</b>	75,864	80,866	3,835	9,944	7,232	611	2,110

Order Code	Specification Information	Refer To Accessories Section	Pricing Tiers
Example: <b>02B48X96-GE01-PM01-MC01-GM2-MC01-UCO</b>	<b>To order please specify pattern number including:</b>	Please refer to Accessories section, <b>page 213</b> for power details.	Please refer to Materials and Finish <b>page 9</b> for specification details.
<b>02</b> Highline Collection	1. Top finish	<b>Grommet options available in these finishes:</b>	T1 and T2 pricing includes powder coated base finish.
<b>B</b> Boat Shaped	2. Trim Finish (only applies if trim type is metal or leather)	Powder coated	There is an upcharge for plated base finishes as highlighted above.
<b>48</b> Depth	3. Base finish	Premium (Polished Chrome, Satin Nickel or Oil Rubbed Bronze)	For additional stone options and pricing please contact your sales representative."
<b>96</b> Width	4. Grommet option	<b>Power Box Options</b>	
<b>GE01</b> Top Finish	5. Grommet finish (only applies if grommets are selected)	<b>Code: Description:</b>	
<b>PM01</b> Trim Finish	6. Power box option	NP No Power	
<b>MC01</b> Base Finish	7. Table-top power finish (only applies if table-top power is selected)	UCO Undermount	
<b>GM2</b> Grommet Opt.	<b>Trim Type</b>	ECO Edgemount	
<b>MC01</b> Grommet Finish	N = No trim	T1E Tabletop 1-Sided Lid	
<b>UCO</b> Undermount	M = Metal (available in Premium and Powder Coat finishes)	T2C Tabletop 2-Sided Lid	
	L = Leather	<b>Must select Wire Management Column and Finish:</b>	
		Powder coated	
		Premium (Polished Chrome, Satin Nickel or Oil Rubbed Bronze)	

# Boat Conference Tables

## 48"-72" Deep Boat Tops

### Corian Top

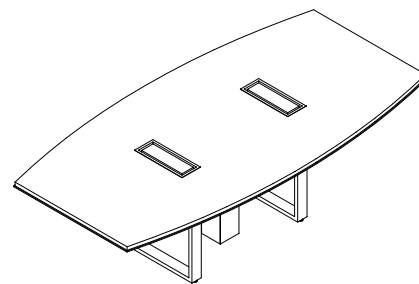

D	W	Pattern No.	CS01 Top	PM01/ PM02 Edge Upcharge	PM03 Edge Upcharge	AU__ Edge Upcharge	PM01/ PM02 Base Upcharge	PM03 Base Upcharge
48"	96"	<b>02B48X96</b>	\$31,059	\$2,403	\$6,082	\$3,216	\$429	\$841
48"	108"	<b>02B48X108</b>	32,956	2,403	6,083	3,502	429	841
48"	120"	<b>02B48X120</b>	35,569	2,413	6,095	3,786	429	841
60"	120"	<b>02B60X120</b>	39,030	2,413	6,095	4,074	408	1,408
60"	132"	<b>02B60X132</b>	44,651	3,250	8,110	4,361	408	1,408
60"	144"	<b>02B60X144</b>	49,482	3,171	8,110	4,647	611	2,110
60"	156"	<b>02B60X156</b>	52,079	3,170	8,109	4,933	611	2,110
72"	168"	<b>02B60X168</b>	55,709	3,210	8,110	5,222	611	2,110
72"	180"	<b>02B72X180</b>	68,511	3,223	8,110	5,794	611	2,110
72"	192"	<b>02B72X192</b>	72,641	3,782	9,892	6,083	611	2,110
72"	204"	<b>02B72X204</b>	75,853	3,782	9,892	6,370	611	2,110
72"	216"	<b>02B72X216</b>	79,873	3,782	9,944	6,657	611	2,110
72"	228"	<b>02B72X228</b>	82,485	3,835	9,944	6,942	611	2,110
72"	240"	<b>02B72X240</b>	87,185	3,835	9,944	7,232	611	2,110

Order Code	Specification Information	Refer To Accessories Section	Pricing Tiers
Example: <b>02B48X96-CS01-PM01-MC01-GM2-MC01-UCO</b>	<b>To order please specify pattern number including:</b>	Please refer to Accessories section, <b>page 213</b> for power details.	Please refer to Materials and Finish <b>page 9</b> for specification details.
<b>02</b> Highline Collection	1. Top finish	<b>Grommet options available in these finishes:</b>	T1 and T2 pricing includes powder coated base finish.
<b>B</b> Boat Shaped	2. Trim Finish (only applies if trim type is metal or leather)	Powder coated	There is an upcharge for plated base finishes as highlighted above.
<b>48</b> Depth	3. Base finish	Premium (Polished Chrome, Satin Nickel or Oil Rubbed Bronze)	For additional stone options and pricing please contact your sales representative."
<b>96</b> Width	4. Grommet option	<b>Power Box Options</b>	
<b>CS01</b> Top Finish	5. Grommet finish (only applies if grommets are selected)	<b>Code: Description:</b>	
<b>PM01</b> Trim Finish	6. Power box option	NP No Power	
<b>MC01</b> Base Finish	7. Table-top power finish (only applies if table-top power is selected)	UCO Undermount	
<b>GM2</b> Grommet Opt.	<b>Trim Type</b>	ECO Edgemount	
<b>MC01</b> Grommet Finish	N = No trim	T1E Tabletop 1-Sided Lid	
<b>UCO</b> Undermount	M = Metal (available in Premium and Powder Coat finishes)	T2C Tabletop 2-Sided Lid	
	L = Leather	<b>Must select Wire Management Column and Finish:</b>	
		Powder coated	
		Premium (Polished Chrome, Satin Nickel or Oil Rubbed Bronze)	



# Trapezoid Conference Tables

**48"-72" Deep Tops**

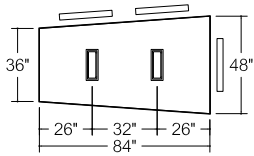
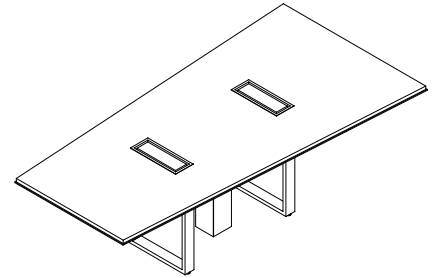

**O2T48X84**  
6 Person Table

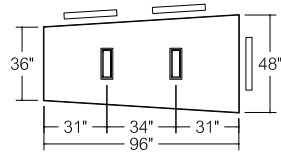

**O2T48X96**  
6 Person Table

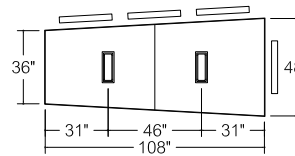

**O2T48X108**  
8 Person Table

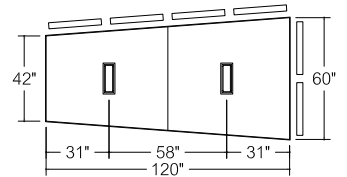

**O2T60X120**  
11 Person Table

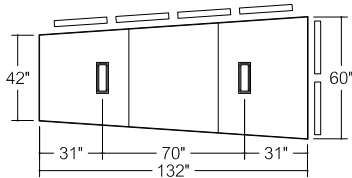

**O2T60X132**  
11 Person Table

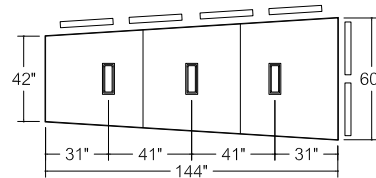

**O2T60X144**  
11 Person Table

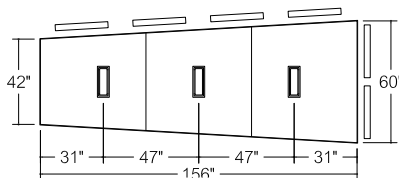

**O2T60X156**  
13 Person Table

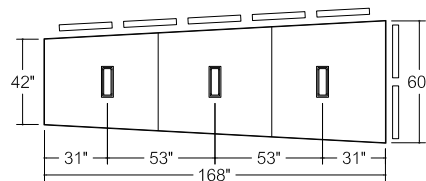

**O2T60X168**  
13 Person Table

# Trapezoid Conference Tables

## 48"-72" Deep Tops

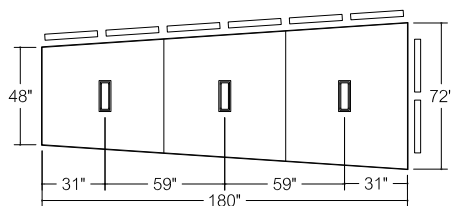
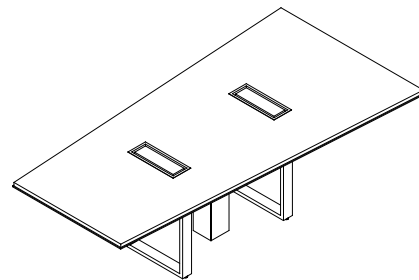

**02T72X180**  
15 Person Table

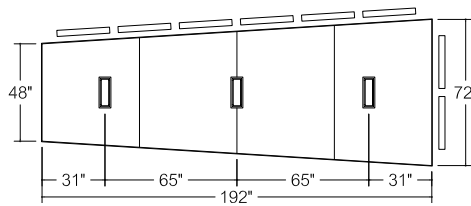

**02T72X192**  
15 Person Table

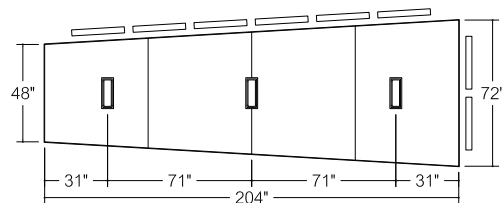

**02T72X204**  
15 Person Table

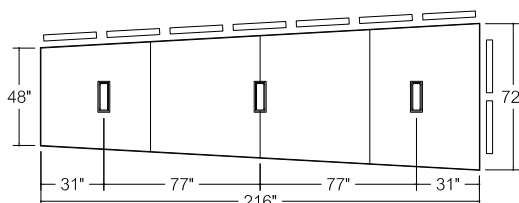

**02T72X216**  
17 Person Table

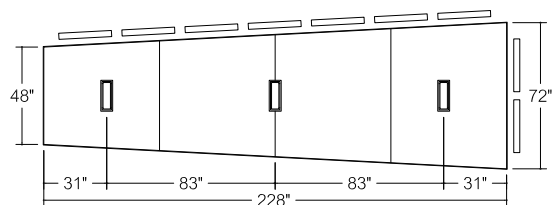

**02T72X228**  
17 Person Table

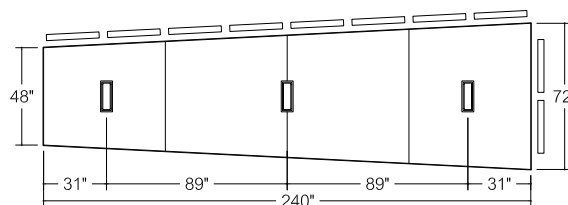

**02T72X240**  
19 Person Table

# Trapezoid Conference Tables

## 48"-72" Deep Trapezoid Tops

### Veneer Top

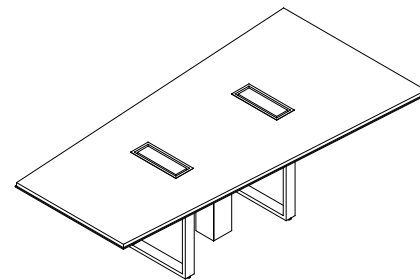

D	W	Pattern No.	T1__ Top	T2__ Top	PM01/ PM02 Edge Upcharge	PM03 Edge Upcharge	AU__ Edge Upcharge	PM01/ PM02 Base Upcharge	PM03 Base Upcharge
48"	84"	<b>02T48X84</b>	\$13,530	\$14,390	\$1,041	\$1,041	\$2,411	\$429	\$841
48"	96"	<b>02T48X96</b>	14,521	15,499	1,041	1,041	2,641	429	841
48"	108"	<b>02T48X108</b>	15,045	16,149	1,041	1,041	2,869	429	841
60"	120"	<b>02T60X120</b>	18,723	20,257	877	877	3,274	429	841
60"	132"	<b>02T60X132</b>	22,562	24,249	1,279	1,279	3,501	429	841
60"	144"	<b>02T60X144</b>	23,678	25,518	1,279	1,279	3,732	644	1,260
60"	156"	<b>02T60X156</b>	24,262	26,255	1,279	1,279	3,961	644	1,260
72"	168"	<b>02T60X168</b>	25,867	28,012	2,086	2,086	4,188	644	1,260
72"	180"	<b>02T72X180</b>	30,765	33,523	2,085	2,085	4,593	644	1,260
72"	192"	<b>02T72X192</b>	31,908	34,851	2,085	2,085	4,821	644	1,260
72"	204"	<b>02T72X204</b>	32,845	35,972	2,085	2,085	5,051	644	1,260
72"	216"	<b>02T72X216</b>	33,795	37,106	2,085	2,085	5,280	644	1,260
72"	228"	<b>02T72X228</b>	34,711	38,207	2,085	2,085	5,509	644	1,260
72"	240"	<b>02T72X240</b>	35,655	39,334	2,085	2,085	5,736	644	1,260

Order Code	Specification Information	Refer To Accessories Section	Pricing Tiers
Example: <b>02T48X96-T003-PM01-MC01-GM2-MC01-UCO</b>	<b>To order please specify pattern number including:</b>	Please refer to Accessories section, <b>page 213</b> for power details.	Please refer to Materials and Finish <b>page 9</b> for specification details.
<b>02</b> Highline Collection	1. Top finish	<b>Grommet options available in these finishes:</b>	T1 and T2 pricing includes powder coated base finish.
<b>T142</b> Trapezoid	2. Trim Finish (only applies if trim type is metal or leather)	Powder coated	There is an upcharge for plated base finishes as highlighted above.
<b>48</b> Depth	3. Base finish	Premium (Polished Chrome, Satin Nickel or Oil Rubbed Bronze)	For additional stone options and pricing please contact your sales representative."
<b>96</b> Width	4. Grommet option	<b>Power Box Options</b>	
<b>T003</b> Top Finish	5. Grommet finish (only applies if grommets are selected)	<b>Code: Description:</b>	
<b>PM01</b> Trim Finish	6. Power box option	NP No Power	
<b>MC01</b> Base Finish	7. Table-top power finish (only applies if table-top power is selected)	UCO Undermount	
<b>GM2</b> Grommet Opt.	<b>Trim Type</b>	ECO Edgemount	
<b>MC01</b> Grommet Finish	N = No trim	T1E Tabletop 1-Sided Lid	
<b>UCO</b> Undermount	M = Metal (available in Premium and Powder Coat finishes)	T2C Tabletop 2-Sided Lid	
	L = Leather	<b>Must select Wire Management Column and Finish:</b>	
		Powder coated	
		Premium (Polished Chrome, Satin Nickel or Oil Rubbed Bronze)	



# Trapezoid Conference Tables

## 48"-72" Deep Trapezoid Tops

### Glass Top

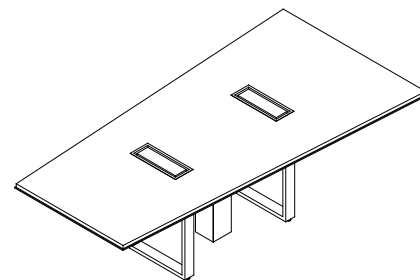

D	W	Pattern No.	GC__ Top	GE__ Top	PM01/	PM01/	PM01/	PM01/	PM01/
					PM02 Edge	PM03 Edge	AU__ Edge	PM02 Base	PM03 Base
					Upcharge	Upcharge	Upcharge	Upcharge	Upcharge
48"	84"	<b>02T48X84</b>	\$19,937	\$21,105	\$1,041	\$1,041	\$2,411	\$429	\$841
48"	96"	<b>02T48X96</b>	21,802	23,134	1,041	1,041	2,641	429	841
48"	108"	<b>02T48X108</b>	23,183	24,684	1,041	1,041	2,869	429	841
60"	120"	<b>02T60X120</b>	29,934	32,019	877	877	3,274	429	841
60"	132"	<b>02T60X132</b>	34,977	37,269	1,279	1,279	3,501	429	841
60"	144"	<b>02T60X144</b>	37,183	39,684	1,279	1,279	3,732	644	1,260
60"	156"	<b>02T60X156</b>	38,834	41,543	1,279	1,279	3,961	644	1,260
72"	168"	<b>02T60X168</b>	41,547	44,463	2,086	2,086	4,188	644	1,260
72"	180"	<b>02T72X180</b>	50,820	54,573	2,085	2,085	4,593	644	1,260
72"	192"	<b>02T72X192</b>	53,262	57,264	2,085	2,085	4,821	644	1,260
72"	204"	<b>02T72X204</b>	55,490	59,741	2,085	2,085	5,051	644	1,260
72"	216"	<b>02T72X216</b>	57,730	62,232	2,085	2,085	5,280	644	1,260
72"	228"	<b>02T72X228</b>	59,937	64,687	2,085	2,085	5,509	644	1,260
72"	240"	<b>02T72X240</b>	62,170	67,170	2,085	2,085	5,736	644	1,260

Order Code	Specification Information	Refer To Accessories Section	Pricing Tiers
Example: <b>02T48X96-GE01-PM01-MC01-GM2-MC01-UCO</b>	<b>To order please specify pattern number including:</b>	Please refer to Accessories section, <b>page 213</b> for power details.	Please refer to Materials and Finish <b>page 9</b> for specification details.
<b>02</b> Highline Collection	1. Top finish	<b>Grommet options available in these finishes:</b>	T1 and T2 pricing includes powder coated base finish.
<b>T</b> Trapezoid	2. Trim Finish (only applies if trim type is metal or leather)	Powder coated	There is an upcharge for plated base finishes as highlighted above.
<b>48</b> Depth	3. Base finish	Premium (Polished Chrome, Satin Nickel or Oil Rubbed Bronze)	For additional stone options and pricing please contact your sales representative."
<b>96</b> Width	4. Grommet option	<b>Power Box Options</b>	
<b>GE01</b> Top Finish	5. Grommet finish (only applies if grommets are selected)	<b>Code: Description:</b>	
<b>PM01</b> Trim Finish	6. Power box option	NP No Power	
<b>MC01</b> Base Finish	7. Table-top power finish (only applies if table-top power is selected)	UCO Undermount	
<b>GM2</b> Grommet Opt.	<b>Trim Type</b>	ECO Edgemount	
<b>MC01</b> Grommet Finish	N = No trim	T1E Tabletop 1-Sided Lid	
<b>UCO</b> Undermount	M = Metal (available in Premium and Powder Coat finishes)	T2C Tabletop 2-Sided Lid	
	L = Leather	<b>Must select Wire Management Column and Finish:</b>	
		Powder coated	
		Premium (Polished Chrome, Satin Nickel or Oil Rubbed Bronze)	

# Trapezoid Conference Tables

## 48"-72" Deep Trapezoid Tops

### Corian Top

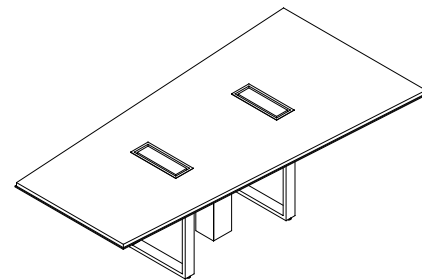

D	W	Pattern No.	CS01 Top	PM01/ PM02 Edge Upcharge	PM03 Edge Upcharge	AU__ Edge Upcharge	PM01/ PM02 Base Upcharge	PM03 Base Upcharge
48"	84"	<b>02T48X84</b>	\$22,489	\$1,041	\$1,041	\$2,411	\$429	\$841
48"	96"	<b>02T48X96</b>	24,757	1,041	1,041	2,641	429	841
48"	108"	<b>02T48X108</b>	26,561	1,041	1,041	2,869	429	841
60"	120"	<b>02T60X120</b>	34,719	877	877	3,274	429	841
60"	132"	<b>02T60X132</b>	40,157	1,279	1,279	3,501	429	841
60"	144"	<b>02T60X144</b>	42,874	1,279	1,279	3,732	644	1,260
60"	156"	<b>02T60X156</b>	45,057	1,279	1,279	3,961	644	1,260
72"	168"	<b>02T60X168</b>	48,260	2,086	2,086	4,188	644	1,260
72"	180"	<b>02T72X180</b>	59,559	2,085	2,085	4,593	644	1,260
72"	192"	<b>02T72X192</b>	62,619	2,085	2,085	4,821	644	1,260
72"	204"	<b>02T72X204</b>	65,477	2,085	2,085	5,051	644	1,260
72"	216"	<b>02T72X216</b>	68,347	2,085	2,085	5,280	644	1,260
72"	228"	<b>02T72X228</b>	71,184	2,085	2,085	5,509	644	1,260
72"	240"	<b>02T72X240</b>	74,046	2,085	2,085	5,736	644	1,260

Order Code	Specification Information	Refer To Accessories Section	Pricing Tiers
Example: <b>02T48X96-CS01-PM01-MC01-GM2-MC01-UCO</b>	<b>To order please specify pattern number including:</b>	Please refer to Accessories section, <a href="#">page 213</a> for power details.	Please refer to Materials and Finish <a href="#">page 9</a> for specification details.
<b>02</b> Highline Collection	1. Top finish	<b>Grommet options available in these finishes:</b>	T1 and T2 pricing includes powder coated base finish.
<b>T</b> Trapezoid	2. Trim Finish (only applies if trim type is metal or leather)	Powder coated	There is an upcharge for plated base finishes as highlighted above.
<b>48</b> Depth	3. Base finish	Premium (Polished Chrome, Satin Nickel or Oil Rubbed Bronze)	For additional stone options and pricing please contact your sales representative."
<b>96</b> Width	4. Grommet option	<b>Power Box Options</b>	
<b>CS01</b> Top Finish	5. Grommet finish (only applies if grommets are selected)	<b>Code: Description:</b>	
<b>PM01</b> Trim Finish	6. Power box option	NP No Power	
<b>MC01</b> Base Finish	7. Table-top power finish (only applies if table-top power is selected)	UCO Undermount	
<b>GM2</b> Grommet Opt.	<b>Trim Type</b>	ECO Edgemount	
<b>MC01</b> Grommet Finish	N = No trim	T1E Tabletop 1-Sided Lid	
<b>UCO</b> Undermount	M = Metal (available in Premium and Powder Coat finishes)	T2C Tabletop 2-Sided Lid	
	L = Leather	<b>Must select Wire Management Column and Finish:</b>	
		Powder coated	
		Premium (Polished Chrome, Satin Nickel or Oil Rubbed Bronze)	

# Highline Collection

## Highline Meeting Tables



**DATESWEISER**

# General Specifications

## Highline Meeting Tables

### Overall Elevations and Clearance

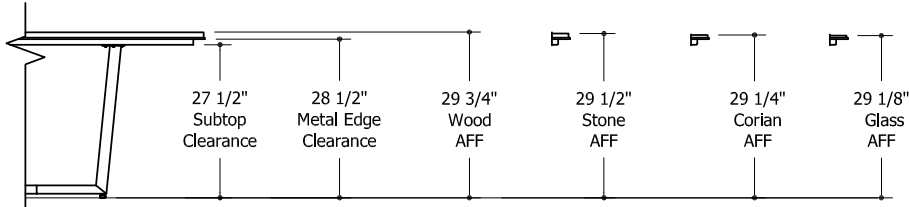

### Round Table Layouts

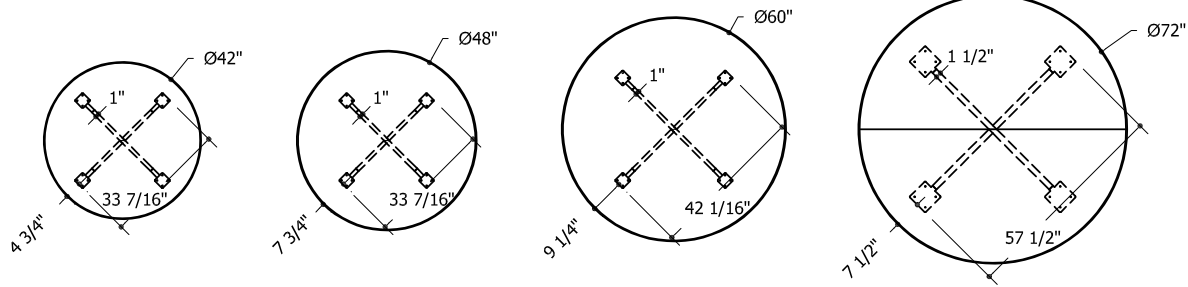

### Square Table Layouts

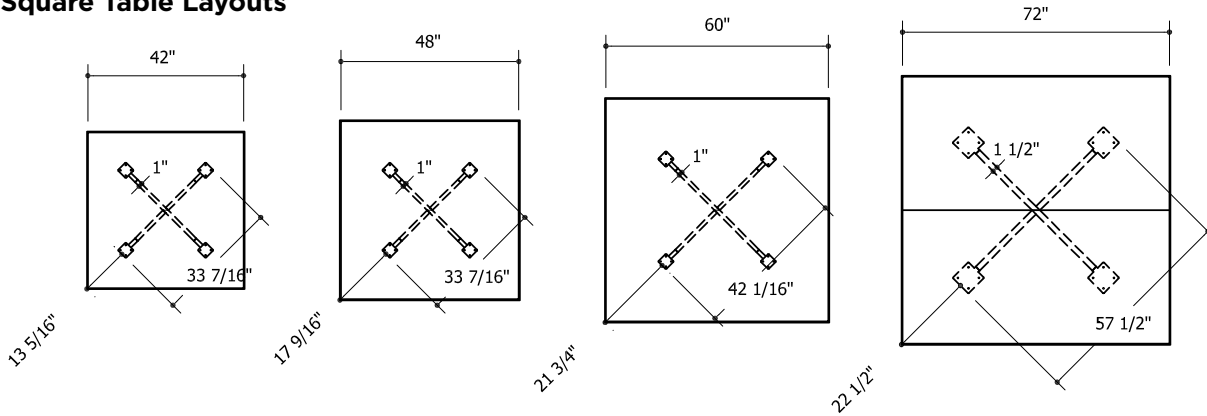

### Elliptical Table Layouts

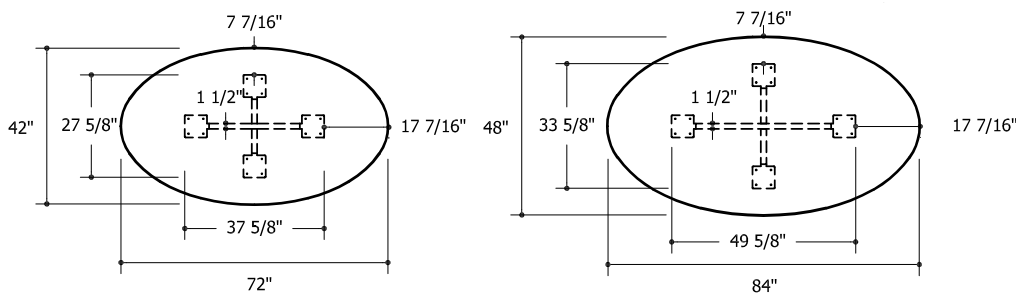

# General Specifications

## Highline Meeting Tables

### Top Construction

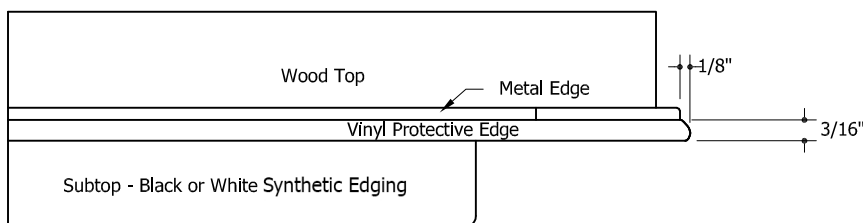
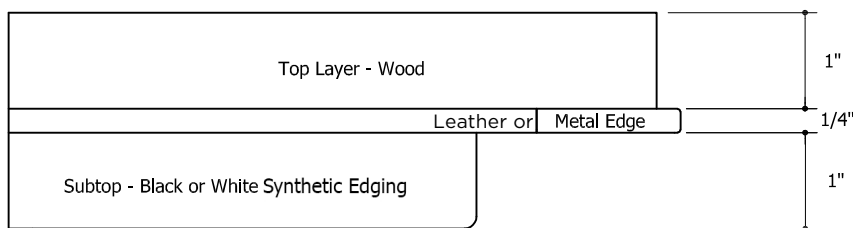
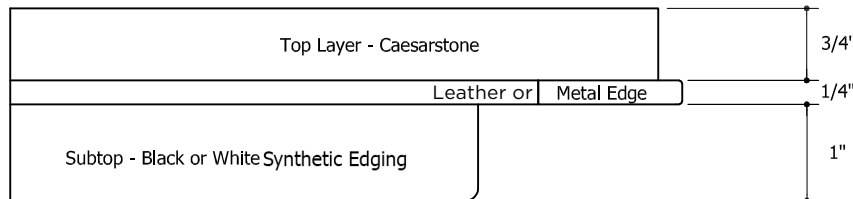
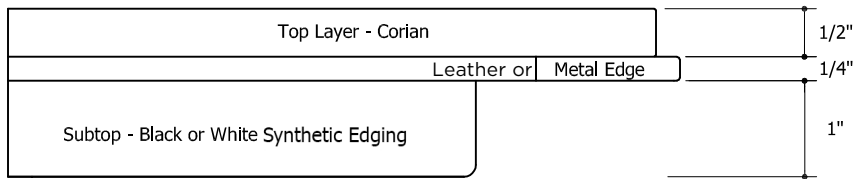
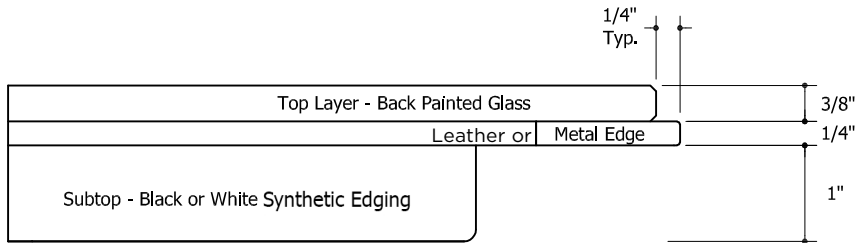

# General Specifications

## Highline Meeting Tables

### Base Construction

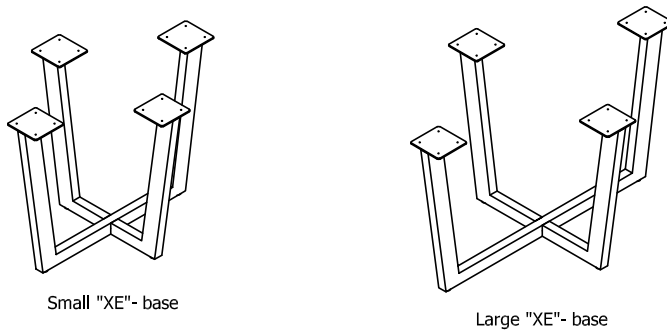
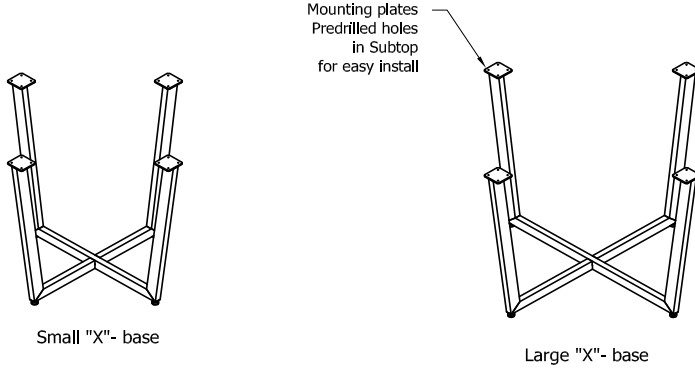

#### Construction

- Tubular steel "X" base
- Small "X" base: 42" / 48" Round and Square meeting tables
- Large "X" base: 60" / 72" Round and Square meeting tables

- Small "XE" base: 42" Elliptical meeting tables
- Large "XE" base: 48" Elliptical meeting tables

- "XP" Wire Management base is automatically included when power and connectivity are specified on Square and Round meeting tables
- "XEP" Wire Management base is automatically included used when power and connectivity are specified on Elliptical meeting tables

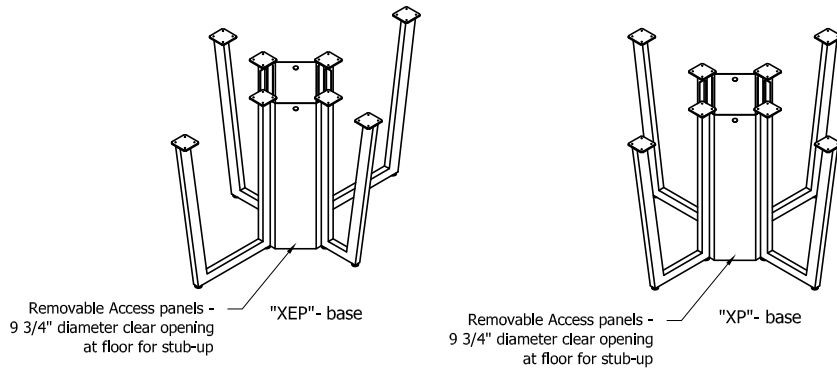

# General Specifications

## Highline Meeting Tables

### Dual Flip Table Top Power & Connectivity Layout

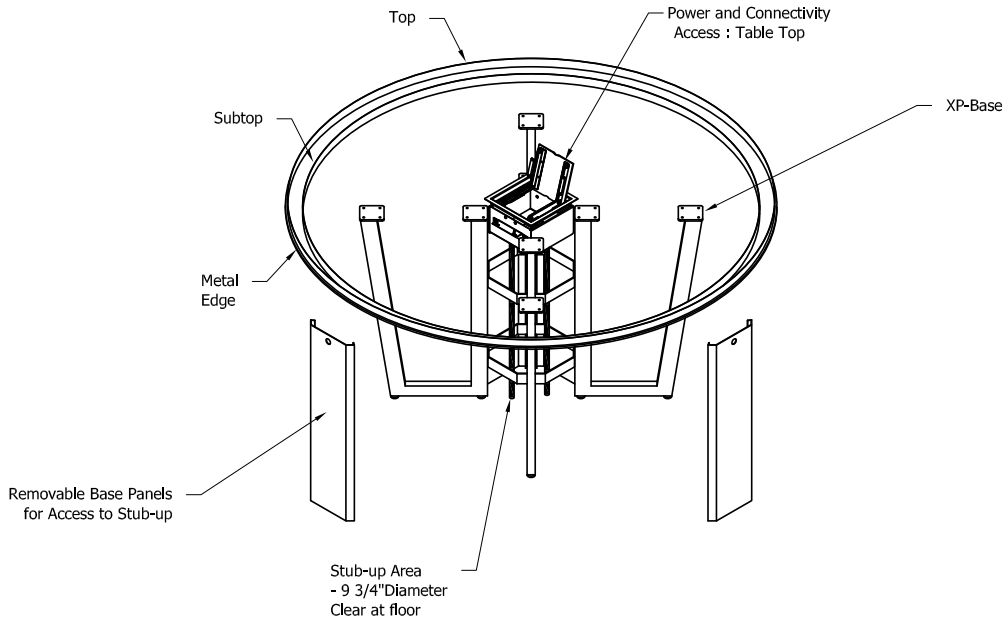

#### For Meeting Tables

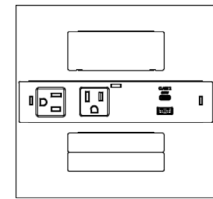
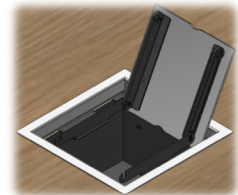

Double-Sided Meeting Table Topmount

### Undermount/edgemount Power & Connectivity Layout

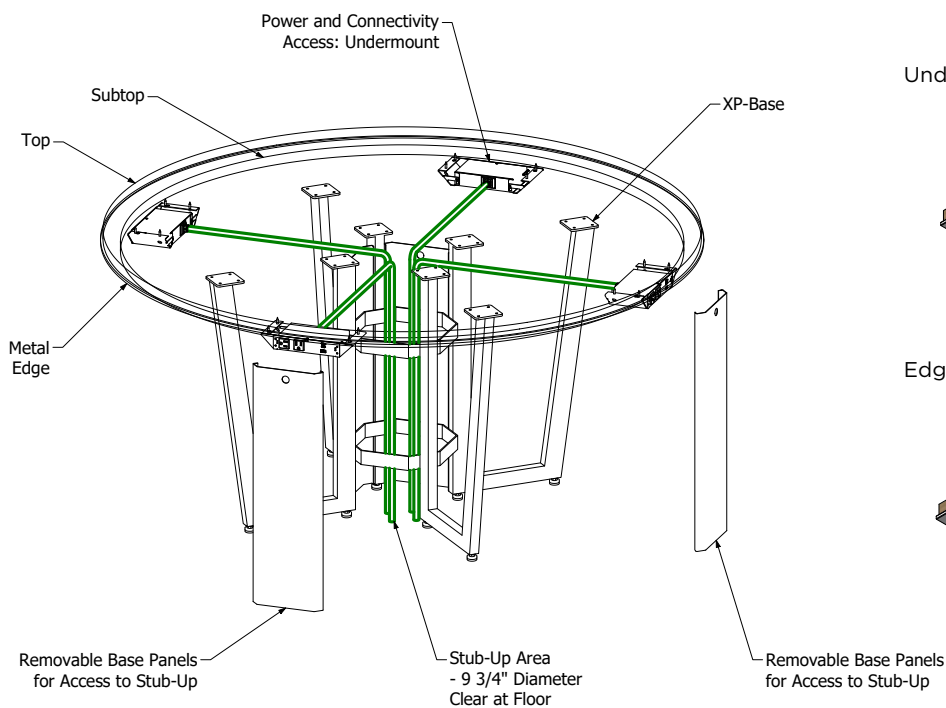

#### Undermount Power

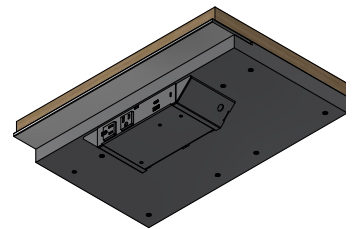

#### Edgemount Power

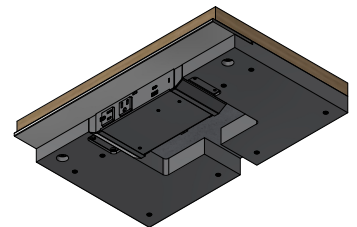

# Highline Meeting Tables

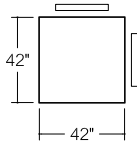
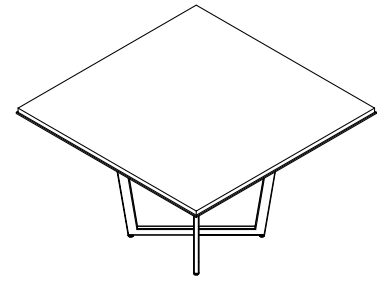

**02M42S**  
4 Person Table

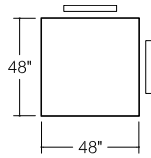

**02M48S**  
4 Person Table

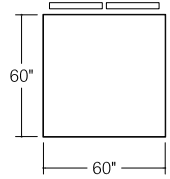

**02M60S**  
8 Person Table

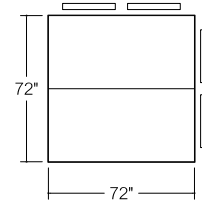

**02M72S**  
8 Person Table

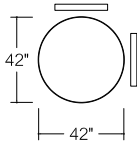

**02M42C**  
4 Person Table

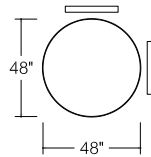

**02M48C**  
4 Person Table

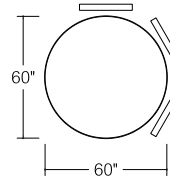

**02M60C**  
6 Person Table

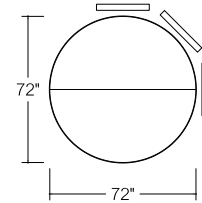

**02M72C**  
8 Person Table

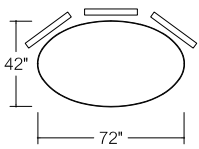

**02M42E**  
6 Person Table

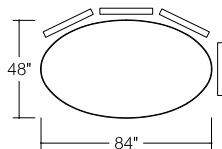

**02M48E**  
8 Person Table



# Highline Meeting Tables

## Square, Round & Elliptical Meeting Tables

### Veneer Top

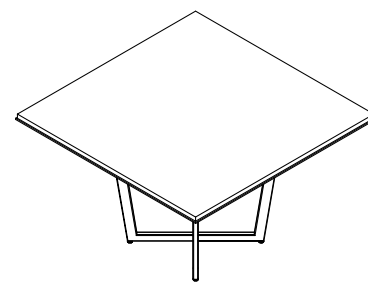

Dimension	Pattern No.	T1__ Top	T2__ Top	PM01/ PM02 Edge Upcharge	PM03 Edge Upcharge	AU__ Edge Upcharge	PM01/ PM02 Base Upcharge	PM03 Base Upcharge
42"x42"	<b>O2M42S</b>	\$15,956	\$16,087	\$390	\$779	\$1,604	\$390	\$2,077
48"x48"	<b>O2M48S</b>	17,009	17,149	390	779	1,834	390	2,077
60"x60"	<b>O2M60S</b>	18,132	18,280	390	779	2,292	506	2,077
72"x72"	<b>O2M72S</b>	19,328	19,487	390	779	2,751	506	2,077
42"D	<b>O2M42C</b>	16,440	16,605	790	1,576	1,583	453	2,077
48"D	<b>O2M48C</b>	17,591	17,767	790	1,576	1,809	453	2,077
60"D	<b>O2M60C</b>	22,693	22,920	790	1,576	2,262	634	2,077
72"D	<b>O2M72C</b>	27,004	27,274	790	1,576	2,715	634	2,077
42"x72"	<b>O2M42E</b>	29,497	29,731	790	1,576	2,204	730	2,324
48"x84"	<b>O2M48E</b>	31,857	32,109	790	1,576	2,553	730	2,324

### Power X Base Upcharges

Pattern No.	Size	Description	MC__	PM01/PM02	PM03
WM	48"D, 60"D, SM Ellipical	Small/LRG Power X Base	\$7,509	\$9,064	\$14,389
WM	72"D and LRG Ellipical	Extra Large Power X Base	\$8,540	\$9,800	\$15,972

**Note: 42"x42" square and 42" diameter tables are not available with power.**

Order Code	Specification Information	Refer To Accessories Section	Pricing Tiers
Example: <b>O2M48S-T003-PM01-MC01-GM1-MC01-UCO</b>	<b>To order please specify pattern number including:</b>	Please refer to Accessories section, <b>page 213</b> for power details.	Please refer to Materials and Finish <b>page 9</b> for specification details.
<b>O2</b> Highline Collection	1. Top finish	<b>Grommet options available in these finishes:</b>	T1 and T2 pricing includes powder coated base finish.
<b>M</b> Meeting	2. Trim Finish (only applies if trim type is metal or leather)	Powder coated	There is an upcharge for plated base finishes as highlighted above.
<b>48</b> Depth	3. Base finish	Premium (Polished Chrome, Satin Nickel or Oil Rubbed Bronze)	For additional stone options and pricing please contact your sales representative."
<b>S</b> Square	4. Grommet option	<b>Power Box Options</b>	
<b>T003</b> Top Finish	5. Grommet finish (only applies if grommets are selected)	<b>Code: Description:</b>	
<b>PM01</b> Trim Finish	6. Power box option	NP No Power	
<b>MC01</b> Base Finish	7. Table-top power finish (only applies if table-top power is selected)	UCO Undermount	
<b>GM1</b> Grommet Opt.	Trim Type	ECO Edgemount	
<b>MC01</b> Grommet Finish	N = No trim	T1E Tabletop 1-Sided Lid	
<b>UCO</b> Undermount	M = Metal (available in Premium and Powder Coat finishes)	T2C Tabletop 2-Sided Lid	
	L = Leather	<b>Must select Wire Management Column and Finish:</b>	
		Powder coated	
		Premium (Polished Chrome, Satin Nickel or Oil Rubbed Bronze)	

# Highline Meeting Tables

## Square, Round & Elliptical Meeting Tables Glass Top

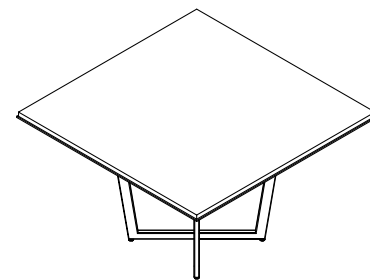

Dimension	Pattern No.	GC__ Top	GE__ Top	PM01/			PM01/	
				PM02 Edge Upcharge	PM03 Edge Upcharge	AU__ Edge Upcharge	PM02 Base Upcharge	PM03 Base Upcharge
42"x42"	<b>02M42S</b>	\$19,147	\$19,626	\$390	\$779	\$1,604	\$390	\$2,077
48"x48"	<b>02M48S</b>	20,411	20,921	390	779	1,834	390	2,077
60"x60"	<b>02M60S</b>	21,758	22,302	390	779	2,292	506	2,077
72"x72"	<b>02M72S</b>	23,194	23,774	390	779	2,751	506	2,077
42"D	<b>02M42C</b>	19,728	20,222	790	1,576	1,583	453	2,077
48"D	<b>02M48C</b>	21,109	21,638	790	1,576	1,809	453	2,077
60"D	<b>02M60C</b>	27,231	27,912	790	1,576	2,262	634	2,077
72"D	<b>02M72C</b>	32,405	33,215	790	1,576	2,715	634	2,077
42"x72"	<b>02M42E</b>	35,396	36,281	790	1,576	2,204	730	2,324
48"x84"	<b>02M48E</b>	38,228	39,185	790	1,576	2,553	730	2,324

### Power X Base Upcharges

Pattern No.	Size	Description	MC__	PM01/PM02	PM03
WM	48"D, 60"D, SM Ellipical	Small/LRG Power X Base	\$7,509	\$9,064	\$14,389
WM	72"D and LRG Ellipical	Extra Large Power X Base	\$8,540	\$9,800	\$15,972

**Note: 42"x42" square and 42" diameter tables are not available with power.**

Order Code	Specification Information	Refer To Accessories Section	Pricing Tiers
Example: <b>02M48S-GE01-PM01-MC01-GM1-MC01-UCO</b>	<b>To order please specify pattern number including:</b>	Please refer to Accessories section, <a href="#">page 213</a> for power details.	Please refer to Materials and Finish <a href="#">page 9</a> for specification details.
<b>02</b> Highline Collection	1. Top finish	<b>Grommet options available in these finishes:</b>	T1 and T2 pricing includes powder coated base finish.
<b>M</b> Meeting	2. Trim Finish (only applies if trim type is metal or leather)	Powder coated	There is an upcharge for plated base finishes as highlighted above.
<b>48</b> Depth	3. Base finish	Premium (Polished Chrome, Satin Nickel or Oil Rubbed Bronze)	For additional stone options and pricing please contact your sales representative."
<b>S</b> Square	4. Grommet option	<b>Power Box Options</b>	
<b>GE01</b> Top Finish	5. Grommet finish (only applies if grommets are selected)	<b>Code: Description:</b>	
<b>PM01</b> Trim Finish	6. Power box option	NP No Power	
<b>MC01</b> Base Finish	7. Table-top power finish (only applies if table-top power is selected)	UCO Undermount	
<b>GM1</b> Grommet Opt.	<b>Trim Type</b>	ECO Edgemount	
<b>MC01</b> Grommet Finish	N = No trim	T1E Tabletop 1-Sided Lid	
<b>UCO</b> Undermount	M = Metal (available in Premium and Powder Coat finishes)	T2C Tabletop 2-Sided Lid	
	L = Leather	<b>Must select Wire Management Column and Finish:</b>	
		Powder coated	
		Premium (Polished Chrome, Satin Nickel or Oil Rubbed Bronze)	

# Highline Meeting Tables

## Square, Round & Elliptical Meeting Tables Corian Top

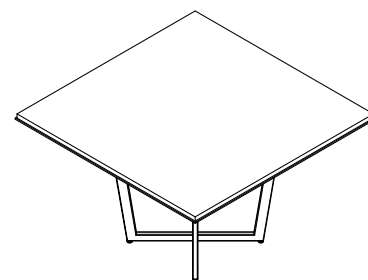

Dimension	Pattern No.	CS01 Top	PM01/ PM02 Edge Upcharge	PM03 Edge Upcharge	AU__ Edge Upcharge	PM01/ PM02 Base Upcharge	PM03 Base Upcharge
42"x42"	<b>02M42S</b>	\$19,233	\$390	\$779	\$1,604	\$390	\$2,077
48"x48"	<b>02M48S</b>	20,502	390	779	1,834	390	2,077
60"x60"	<b>02M60S</b>	21,856	390	779	2,292	506	2,077
72"x72"	<b>02M72S</b>	23,298	390	779	2,751	506	2,077
42"D	<b>02M42C</b>	19,818	790	1,576	1,583	453	2,077
48"D	<b>02M48C</b>	21,204	790	1,576	1,809	453	2,077
60"D	<b>02M60C</b>	27,353	790	1,576	2,262	634	2,077
72"D	<b>02M72C</b>	32,551	790	1,576	2,715	634	2,077
42"x72"	<b>02M42E</b>	35,556	790	1,576	2,204	730	2,324
48"x84"	<b>02M48E</b>	38,401	790	1,576	2,553	730	2,324

### Power X Base Upcharges

Pattern No.	Size	Description	MC__	PM01/PM02	PM03
WM	48"D, 60"D, SM Ellipical	Small/LRG Power X Base	\$7,509	\$9,064	\$14,389
WM	72"D and LRG Ellipical	Extra Large Power X Base	\$8,540	\$9,800	\$15,972

**Note: 42"x42" square and 42" diameter tables are not available with power.**

Order Code	Specification Information	Refer To Accessories Section	Pricing Tiers
Example: <b>02M48S-CS01-PM01-MC01-GM1-MC01-UCO</b>	<b>To order please specify pattern number including:</b>	Please refer to Accessories section, <b>page 213</b> for power details.	Please refer to Materials and Finish <b>page 9</b> for specification details.
<b>02</b> Highline Collection	1. Top finish	<b>Grommet options available in these finishes:</b>	T1 and T2 pricing includes powder coated base finish.
<b>M</b> Meeting	2. Trim Finish (only applies if trim type is metal or leather)	Powder coated	There is an upcharge for plated base finishes as highlighted above.
<b>48</b> Depth	3. Base finish	Premium (Polished Chrome, Satin Nickel or Oil Rubbed Bronze)	For additional stone options and pricing please contact your sales representative."
<b>S</b> Square	4. Grommet option	<b>Power Box Options</b>	
<b>CS01</b> Top Finish	5. Grommet finish (only applies if grommets are selected)	<b>Code: Description:</b>	
<b>PM01</b> Trim Finish	6. Power box option	NP No Power	
<b>MC01</b> Base Finish	7. Table-top power finish (only applies if table-top power is selected)	UCO Undermount	
<b>GM1</b> Grommet Opt.	Trim Type	ECO Edgemount	
<b>MC01</b> Grommet Finish	N = No trim	T1E Tabletop 1-Sided Lid	
<b>UCO</b> Undermount	M = Metal (available in Premium and Powder Coat finishes)	T2C Tabletop 2-Sided Lid	
	L = Leather	<b>Must select Wire Management Column and Finish:</b>	
		Powder coated	
		Premium (Polished Chrome, Satin Nickel or Oil Rubbed Bronze)	



# Highline Collection

## Highline Credenzas



**DATESWEISER**

# General Specifications

## Highline Credenzas

### Credenza Optional Tops

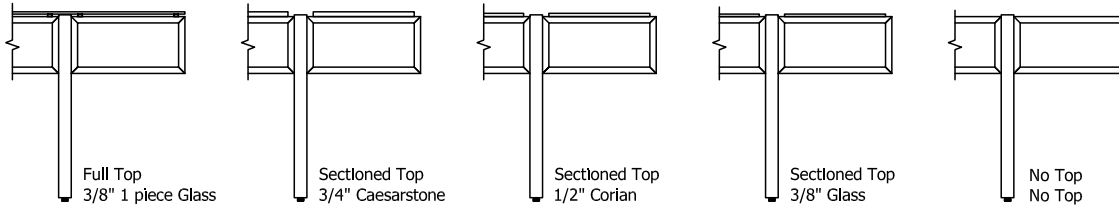

### Sectioned Top Plan

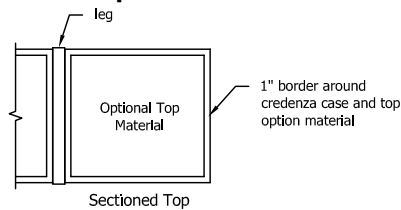

### Credenza Elevations

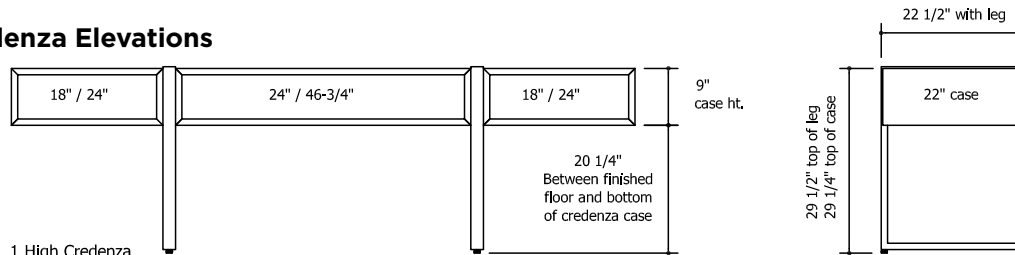

1 High Credenza

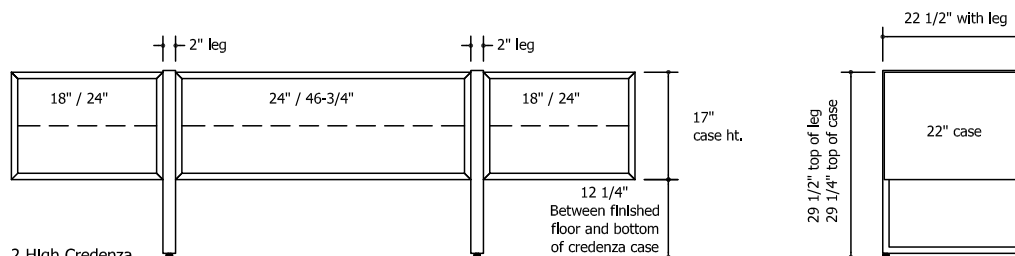

2 High Credenza

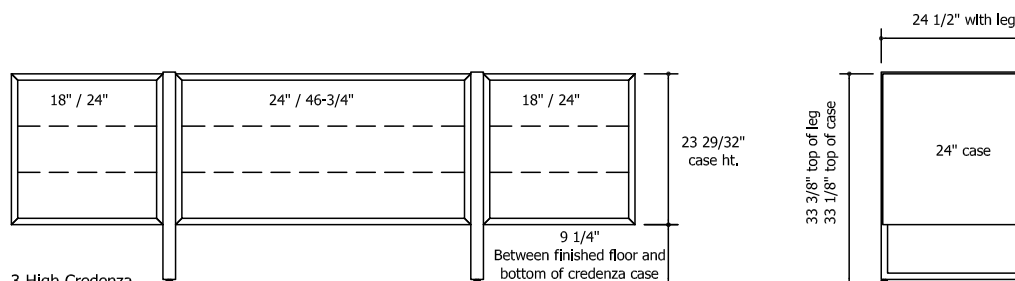

3 High Credenza

# General Specifications

## Highline Credenzas

### Credenza Leg and Case Details

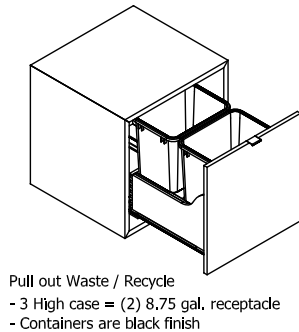
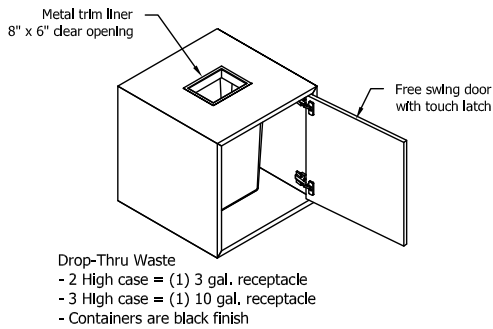
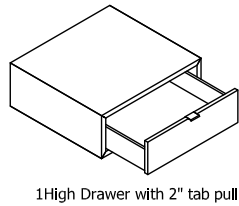
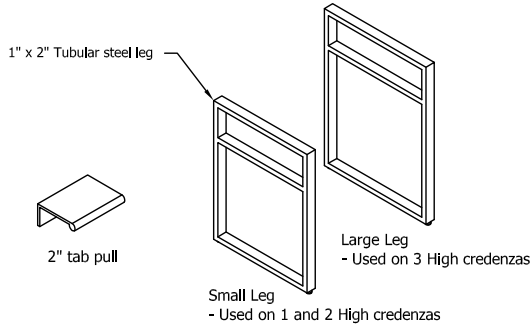

#### Credenza Notes

- Pulls and trash liners come in the specified metal finish
- All drawers have a 2" tab pull located in the center of the top edge of each drawer front
- All drawers use partial extension, self-closing undermount slides
- Pull-out trash units use full extension side mount slides
- Pull-out trash units are a Rev-A-Shelf product
- All doors use free swing hinges and touch latches
- All credenza top material finishes are secured to the case with silicone except for tops finished with full clear glass
- Full clear glass (FG GC00) rests atop of 3/8" bumpers located on top of case
- Drop-through trash option is available with all top options except with full clear glass (FG GC00)

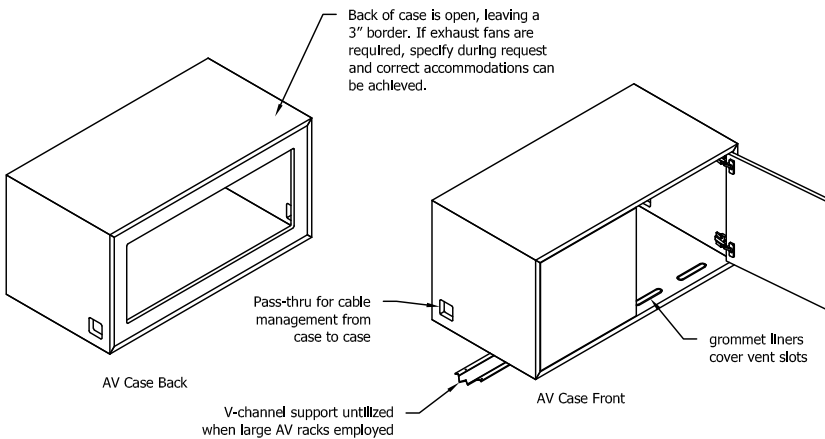

#### AV CASE

- All AV cases have an open back with a 3" border
- Coordinate AV requirements with the interior clearance dimensions provided below to ensure fit

#### 18" Case

14.25" wide x 22.18" deep x 21.15" high

#### 24" Case

20.25" wide x 22.18" deep x 21.15" high

#### 47" Case

41.25" wide x 22.18" deep x 21.15" high

# General Specifications

## Highline 1 High Credenzas

### 1 High - Positional Configurations

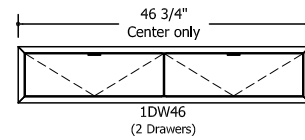
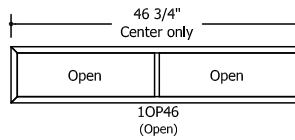
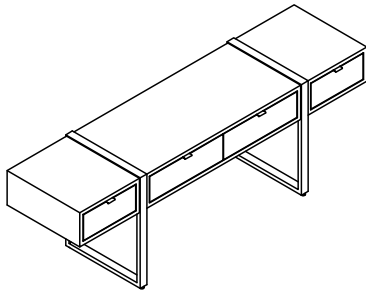
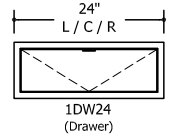
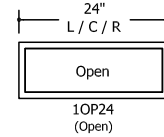
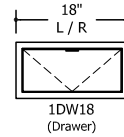
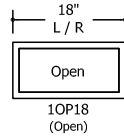
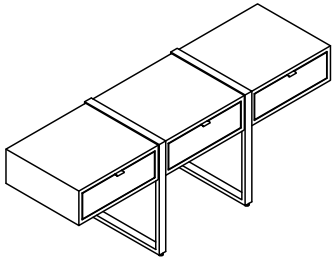



# General Specifications

## Highline 2 High Credenzas

### 2 High - Positional Configurations

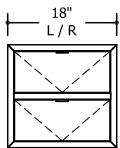
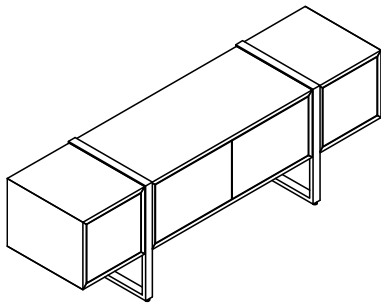

2DW18  
(2 Drawers)

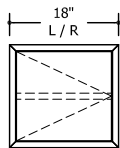

2DR18  
(Door w/adj. Shelf)

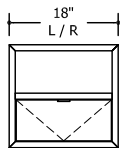

2OW18  
(Open over Drawer)

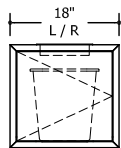

2TT18  
(Trash thru Top  
w/1 single can only)

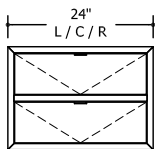

2DW24  
(2 Drawers)

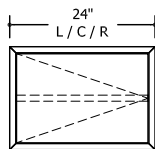

2DR24  
(Door w/adj. Shelf)

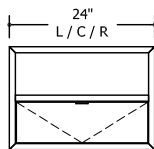

2OW24  
(Open over Drawer)

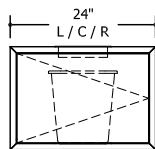

2TT24  
(Trash thru Top  
w/1 single can only)

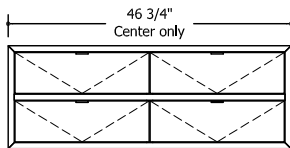

2DW46  
(4 Drawers)

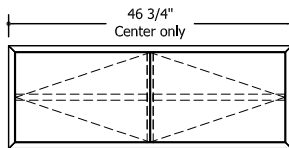

2DR46  
(2 Doors w/2 adj. Shelves)

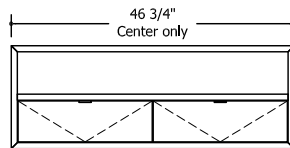

2OW46  
(Open over 2 Drawers)

# General Specifications

## Highline 3 High Credenzas

### 3 High - Positional Configurations

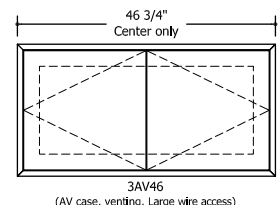
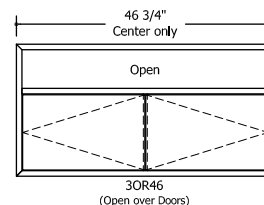
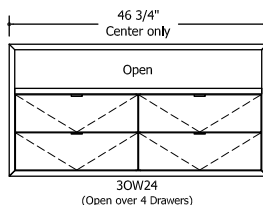
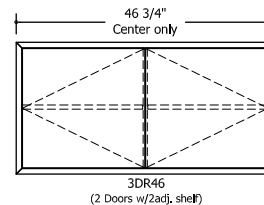
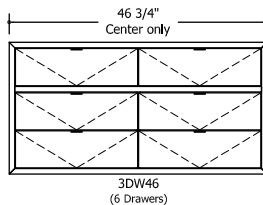
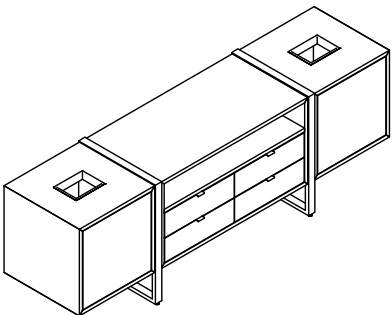
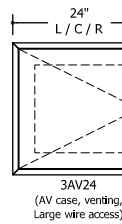
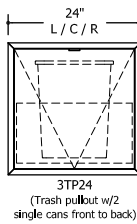
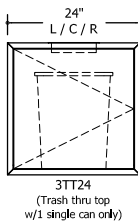
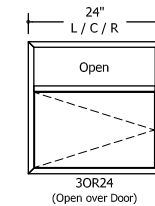
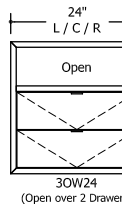
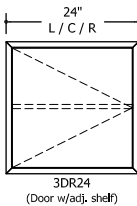
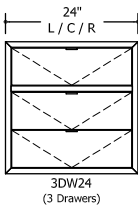
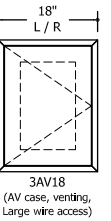
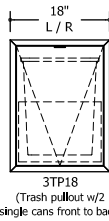
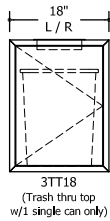
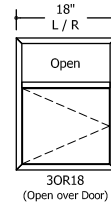
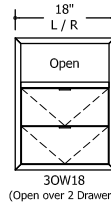
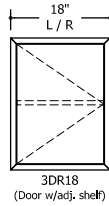
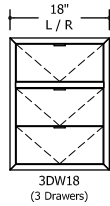
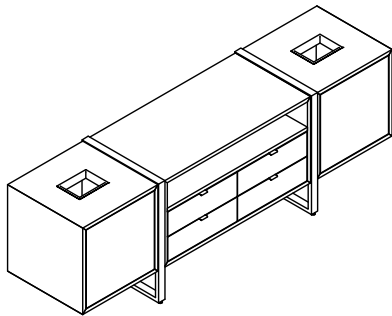



# Highline Credenzas

## Highline 1 High Credenzas

22" Deep, 29" High

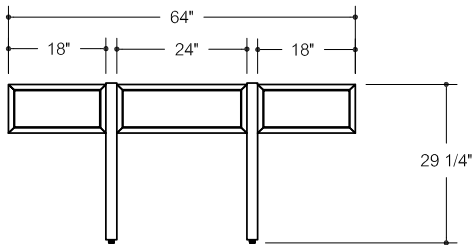

02C1H64

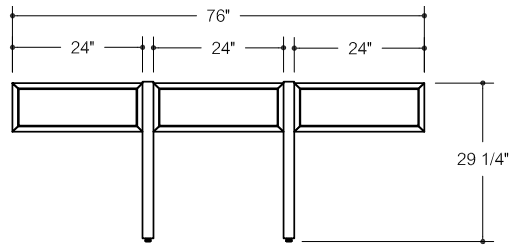

02C1H76

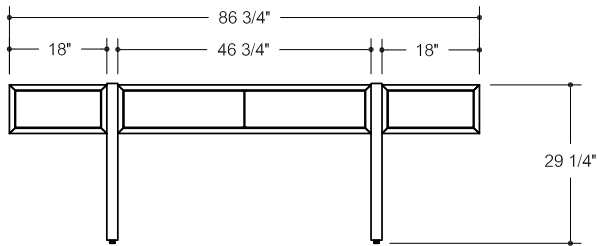

02C1H87

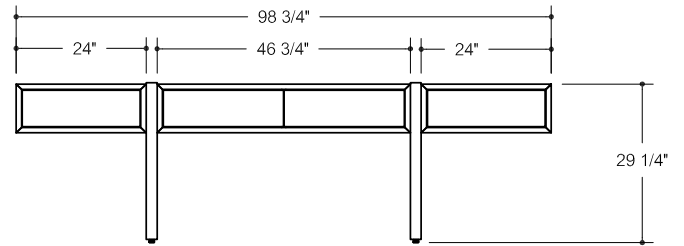

02C1H99

# Highline Credenzas

## Highline 1 High Credenzas

22" Deep, 29" High

Starting price in SL finish and MC base

Pattern No.	Starting Price	T1__ Shell	T2__ Shell	HG__ Shell	PM01/ PM02 Base	PM03 Base	T1__ Face	T2__ Face	HG__ Face
<b>02C1H64</b>	\$10,905	\$1,423	\$2,780	\$4,659	\$466	\$871	\$473	\$926	\$1,553
<b>02C1H76</b>	11,621	1,620	3,169	5,338	466	871	541	1,058	1,778
<b>02C1H87</b>	12,936	1,801	3,531	5,946	466	871	600	1,176	1,983
<b>02C1H99</b>	13,987	1,994	3,920	6,629	466	871	665	1,307	2,211

### Top Upcharges

GC00 Full Top	GC__ Section Top	GC__ Center Top	GE__ Section Top	GE__ Center Top	CS01 Section Top	CS01 Center Top
\$1,209	\$1,463	\$568	\$2,011	\$821	\$2,492	\$1,016
1,439	1,705	568	2,460	821	3,049	1,016
1,639	2,204	1,310	2,906	1,715	3,811	2,335
1,870	2,447	1,310	3,354	1,715	4,367	2,335

### Configuration Upcharges

L	Pattern No.	Description	Price
18"	<b>02OP18H1</b>	Open	\$-
24"	<b>02OP24H1</b>	Open	-
46"	<b>02OP46H1</b>	Open	-
18"	<b>02DW18H1</b>	Drawer	804
24"	<b>02DW24H1</b>	Drawer	818
46"	<b>02DW46H1</b>	Drawer	1,610

# Highline Credenzas

## Highline 2 High Credenzas

22" Deep, 29" High

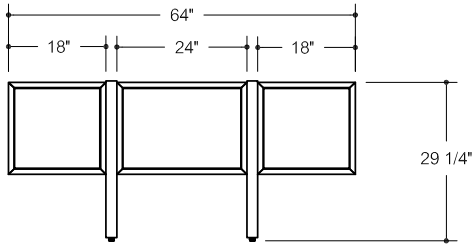

**02C2H64**

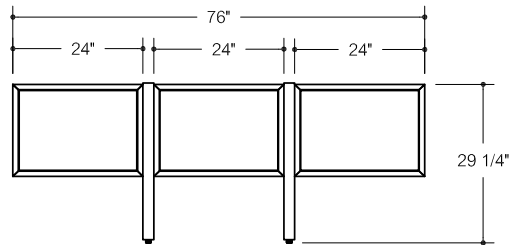

**02C2H76**

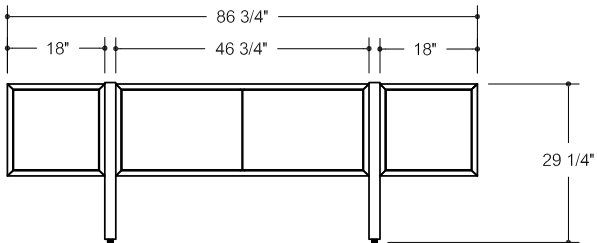

**02C2H87**

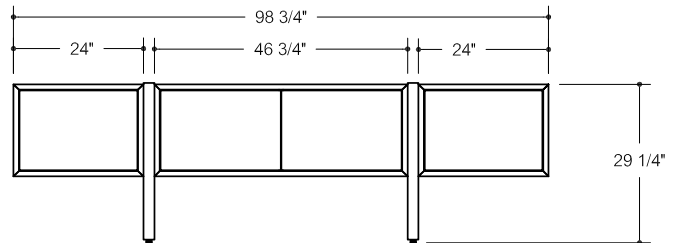

**02C2H99**

# Highline Credenzas

## Highline 2 High Credenzas

22" Deep, 29" High

Starting price in SL finish and MC base

Pattern No.	Starting Price	T1__ Shell	T2__ Shell	HG__ Shell	PM01/ PM02 Base	PM03 Base T1__ Face	T2__ Face	HG__ Face	
<b>02C2H64</b>	\$13,738	\$2,063	\$4,553	\$8,564	\$466	\$871	\$687	\$1,517	\$2,855
<b>02C2H76</b>	14,564	2,267	5,031	9,570	466	871	756	1,677	3,190
<b>02C2H87</b>	16,418	2,530	5,568	10,478	466	871	843	1,855	3,493
<b>02C2H99</b>	17,435	2,787	6,104	11,486	466	871	929	2,036	3,828

### Top Upcharges

GC00 Full Top	GC__ Section Top	GC__ Center Top	GE__ Section Top	GE__ Center Top	CS01 Section Top	CS01 Center Top
\$1,209	\$1,463	\$568	\$2,011	\$821	\$2,492	\$1,016
1,439	1,705	568	2,460	821	3,049	1,016
1,639	2,204	1,310	2,906	1,715	3,811	2,335
1,870	2,447	1,310	3,354	1,715	4,367	2,335

### Configuration Upcharges

L	Pattern No.	Description	Price
18"	<b>02DW18H2</b>	Drawers	\$661
24"	<b>02DW24H2</b>	Drawers	993
46"	<b>02DW46H2</b>	Drawers	1,560
18"	<b>02DR18H2</b>	Door	-
24"	<b>02DR24H2</b>	Door	-
46"	<b>02DR46H2</b>	Door	-
18"	<b>02OW18H2</b>	Open Over Drawer	547
24"	<b>02OW24H2</b>	Open Over Drawer	765
46"	<b>02OW46H2</b>	Open Over Drawer	1,099
18"	<b>02TT18H2</b>	Trash Thru Top	1,112
24"	<b>02TT24H2</b>	Trash Thru Top	1,122

# Highline Credenzas

## Highline 3 High Credenzas

24" Deep, 33" High

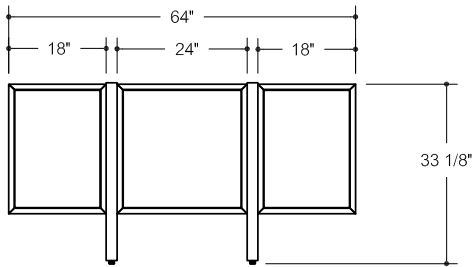

**02C3H64**

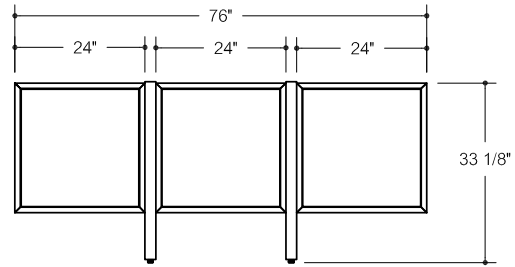

**02C3H76**

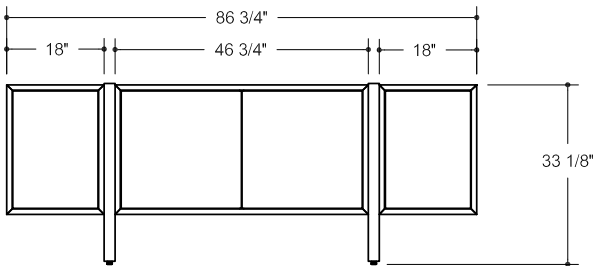

**02C3H87**

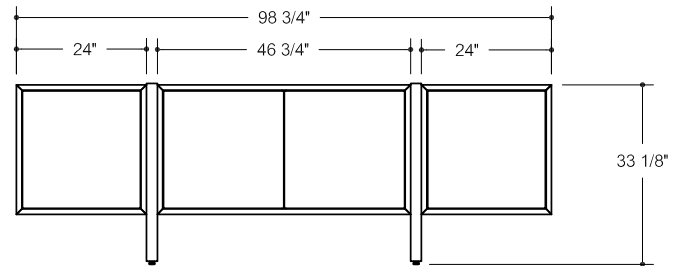

**02C3H99**



# Highline Credenzas

## Highline 3 High Credenzas

24" Deep, 33" High

Starting price in SL finish and MC base

L	Pattern No.	Starting Price	T1__ Shell	T2__ Shell	HG__ Shell	PM01/ PM02 Base	PM03 Base	T1__ Face	T2__ Face	HG__ Face
64"	<b>02C3H64</b>	\$15,070	\$2,569	\$5,946	\$11,665	\$466	\$871	\$855	\$1,983	\$3,890
76"	<b>02C3H76</b>	16,679	2,787	6,509	12,761	466	871	929	2,171	4,254
87"	<b>02C3H87</b>	17,876	3,174	7,209	14,030	466	871	1,059	2,402	4,676
99"	<b>02C3H99</b>	20,035	4,088	8,495	16,040	466	871	1,362	2,832	5,347

### Top Upcharges

GC00 Full Top	GC__ Section Top	GC__ Center Top	GE__ Section Top	GE__ Center Top	CS01 Section Top	CS01 Center Top
\$1,209	\$1,463	\$568	\$2,011	\$821	\$2,492	\$1,016
1,439	1,705	568	2,460	821	3,049	1,016
1,639	2,204	1,310	2,906	1,715	3,811	2,335
1,870	2,447	1,310	3,354	1,715	4,367	2,335

### Configuration Upcharges

L	Pattern No.	Description	Price	L	Pattern No.	Description	Price
18"	<b>02DW18H3</b>	Drawers	\$1,285	18"	<b>02TP18H3</b>	Trash Pull-Out	1,858
24"	<b>02DW24H3</b>	Drawers	1,671	24"	<b>02TP24H3</b>	Trash Pull-Out	1,856
46"	<b>02DW46H3</b>	Drawers	2,156	18"	<b>02AV18H3</b>	AV Case	677
18"	<b>02DR18H3</b>	Door	-	24"	<b>02AV24H3</b>	AV Case	681
24"	<b>02DR24H3</b>	Door	-	46"	<b>02AV46H3</b>	AV Case	559
46"	<b>02DR46H3</b>	Door	-				
18"	<b>02OW18H3</b>	Open Over Drawer	1,046				
24"	<b>02OW24H3</b>	Open Over Drawer	975				
46"	<b>02OW46H3</b>	Open Over Drawer	1,723				
18"	<b>02OR18H3</b>	Open Over Door	914				
24"	<b>02OR24H3</b>	Open Over Door	939				
46"	<b>02OR46H3</b>	Open Over Door	693				
18"	<b>02TT18H3</b>	Trash Thru Top	1,122				
24"	<b>02TT24H3</b>	Trash Thru Top	1,123				



# Highline Fifty Collection

## Highline Fifty Conference Tables



**DATESWEISER**

# General Specifications

## Highline Fifty Conference Tables

### Overall Elevations and Clearance

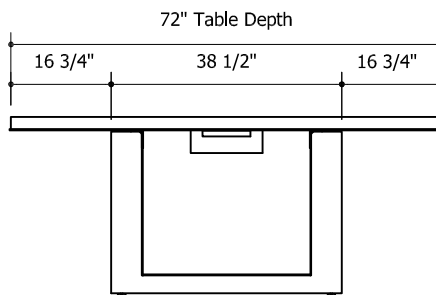
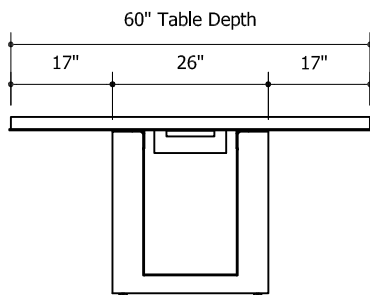
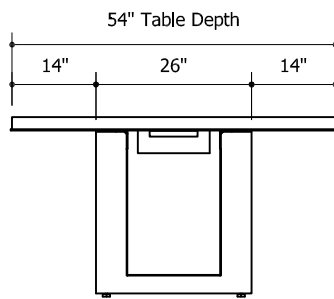
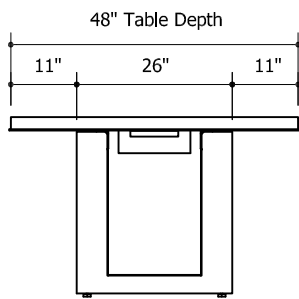
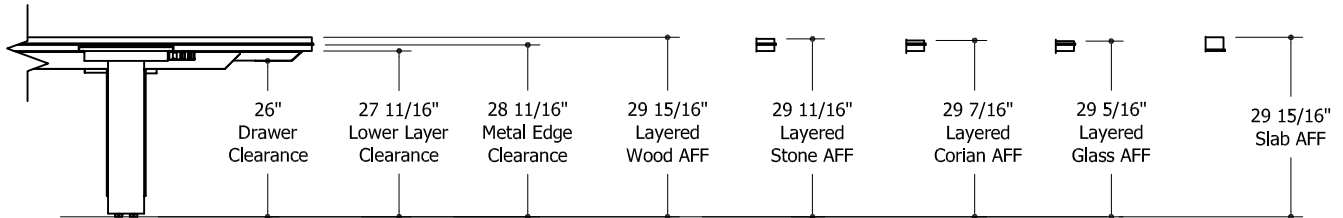

# General Specifications

## Highline Fifty Conference Tables

### Top Construction

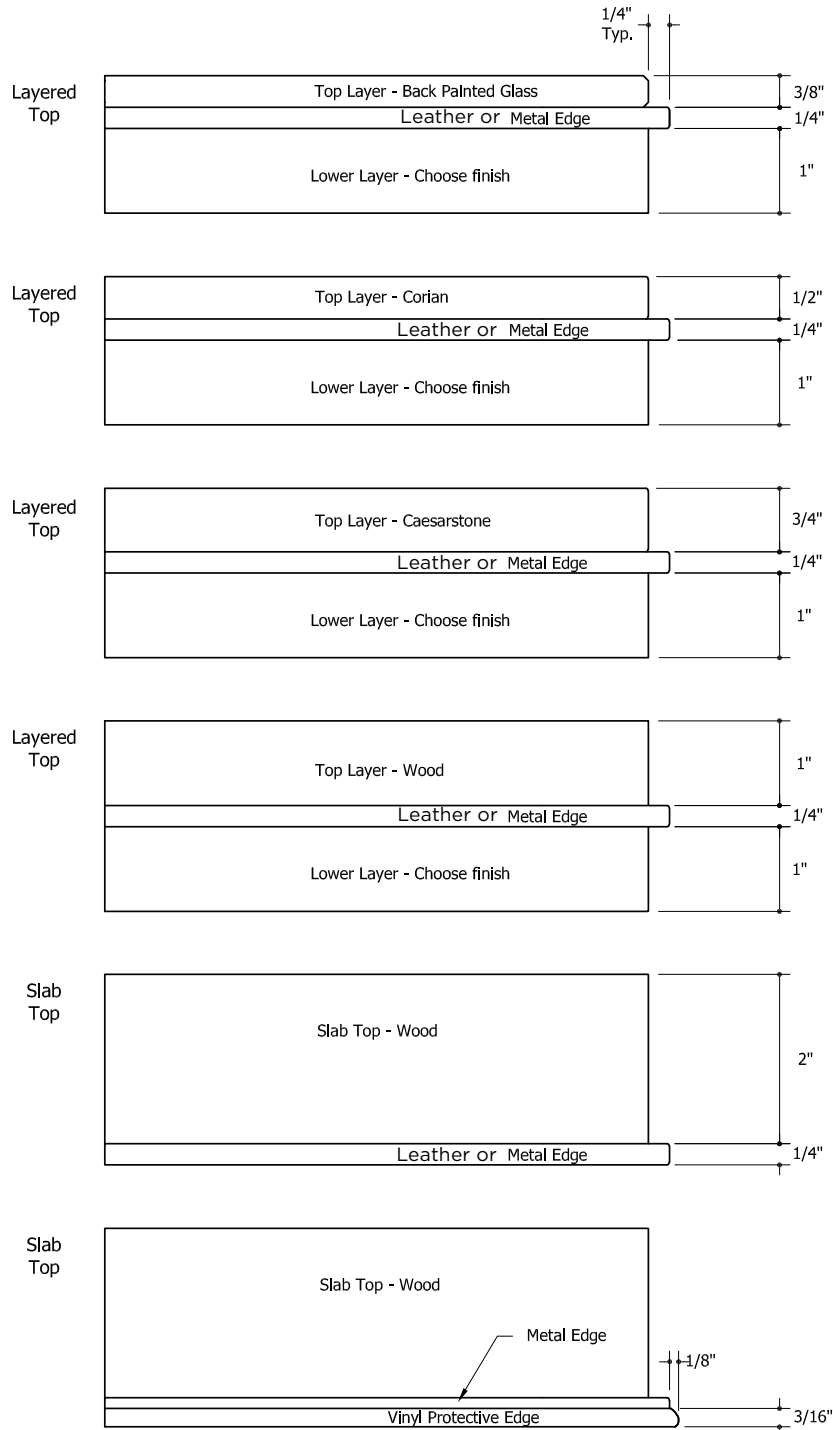

# General Specifications

## Highline Fifty Conference Tables

### Base Construction / Wire Management

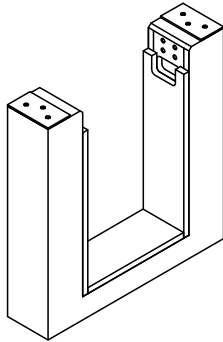

Small base : 42" / 48" / 54" / 60" Deep Tables  
"ON" Open Base, no metal trim

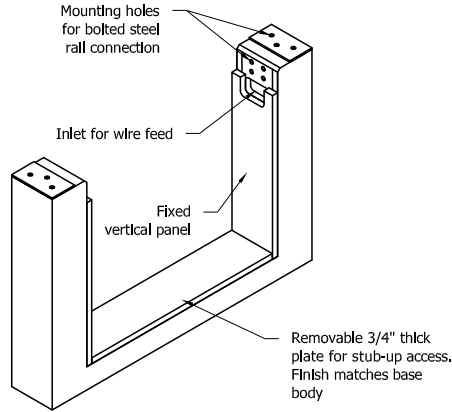

Large base : 72" Deep Tables  
"ON" Open Base, no metal trim

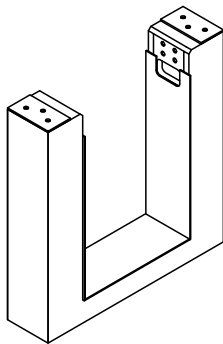

Small base : 42" / 48" / 54" / 60" Deep Tables  
"OT" Open Base, with metal trim

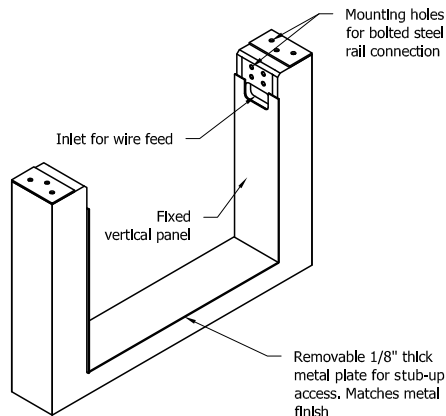

Large base : 72" Deep Tables  
"OT" Open Base, with metal trim

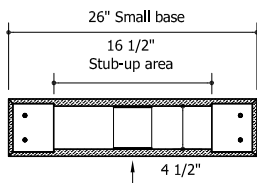

Horizontal section of Small Base

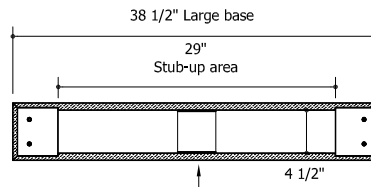

Horizontal section of Large base

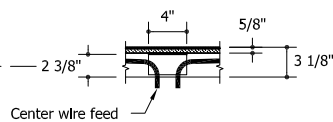

Vertical section at center of Base

# General Specifications

## Highline Fifty Conference Tables

### Power Drawer / Connectivity Layout

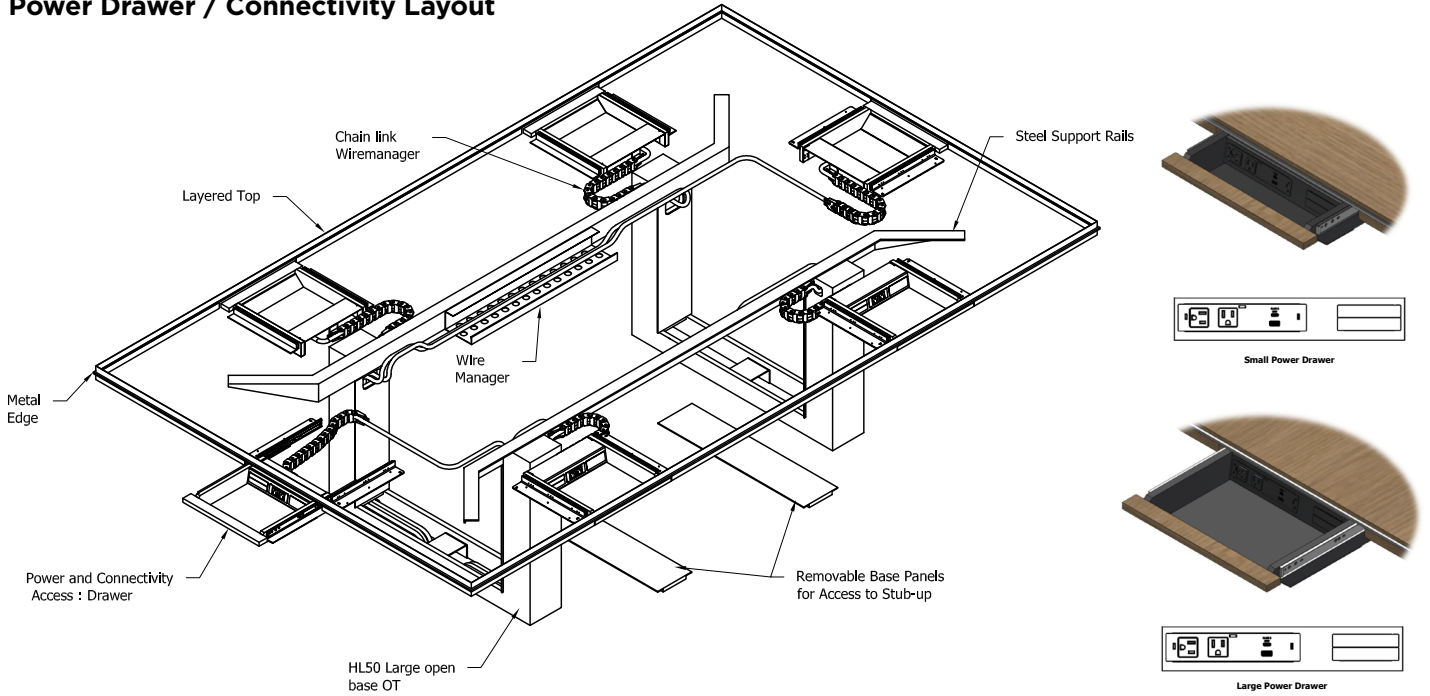

### Table Top Power / Connectivity Layout

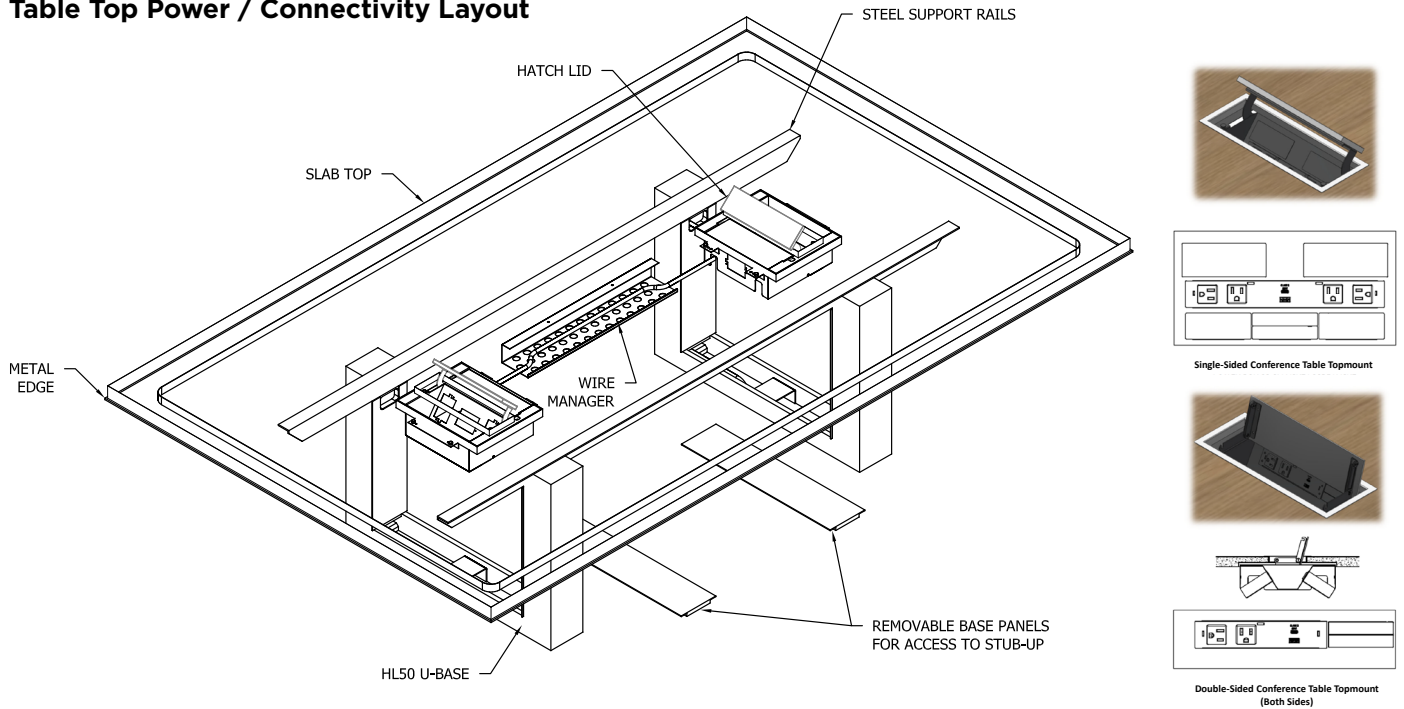

# General Specifications

## Highline Fifty Conference Tables

### Undermount Power / Connectivity Layout

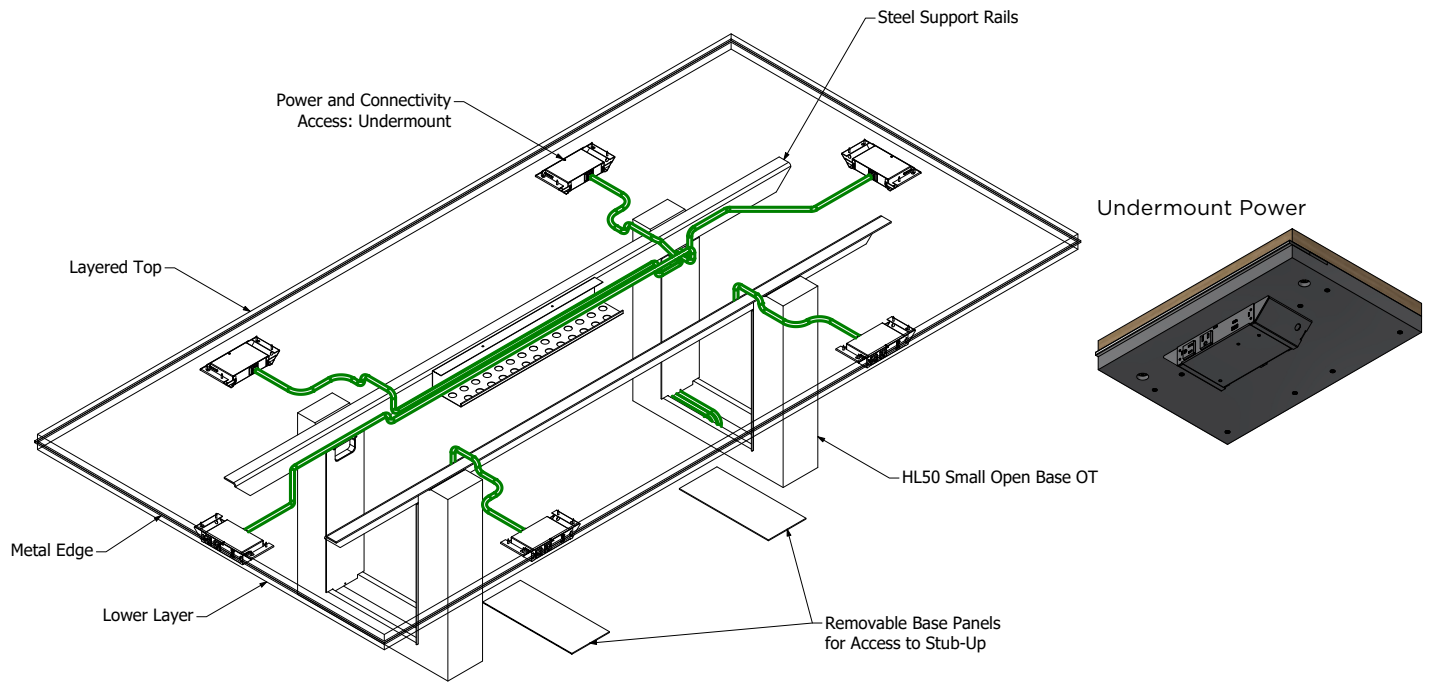



# General Specifications

## Highline Fifty Conference Tables

---

### Undermount Power / Connectivity Layout

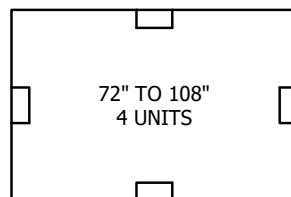
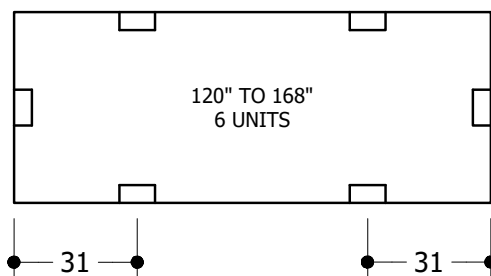
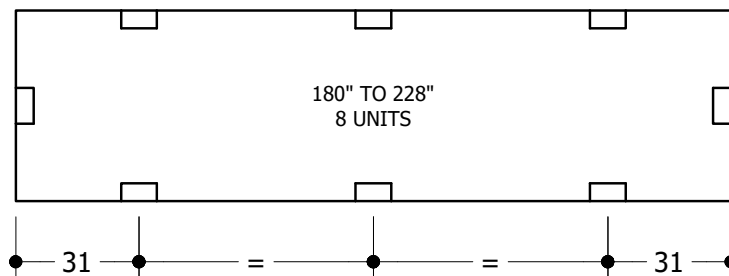
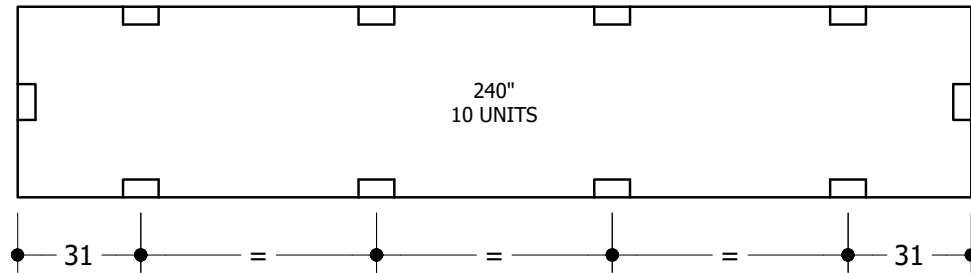

POWER LOCATIONS & QUANTITY BY TABLE LENGTH

# Rectangular Conference Tables

## 48" Deep Tops

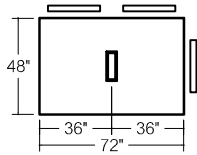
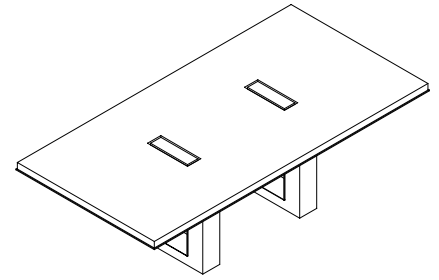

**03R48X72**  
6 Person Table

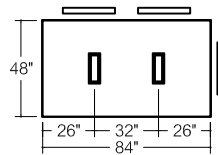

**03R48X84**  
6 Person Table

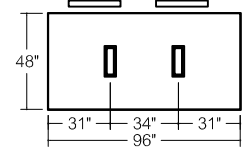

**03R48X96**  
6 Person Table

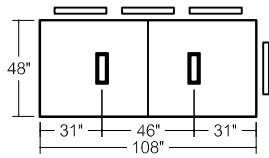

**03R48X108**  
8 Person Table

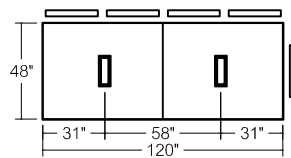

**03R48X120**  
10 Person Table

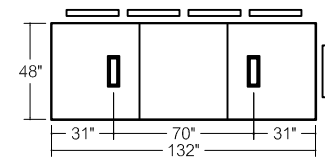

**03R48X132**  
10 Person Table

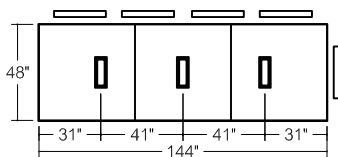

**03R48X144**  
10 Person Table

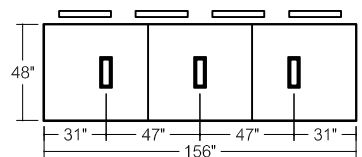

**03R48X156**  
10 Person Table

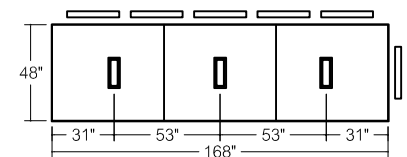

**03R48X168**  
12 Person Table

# Rectangular Conference Tables

## 48" Deep Tops

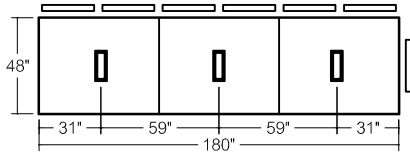
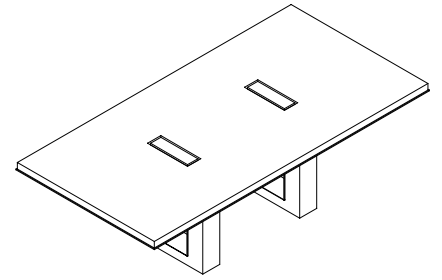

**03R48X180**  
14 Person Table

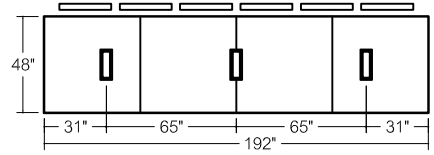

**03R48X192**  
14 Person Table

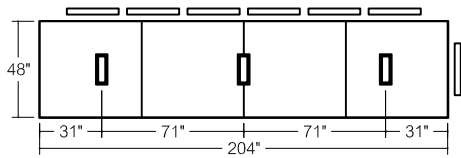

**03R48X204**  
14 Person Table

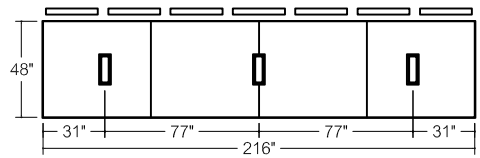

**03R48X216**  
16 Person Table

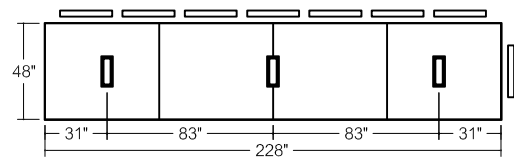

**03R48X228**  
16 Person Table

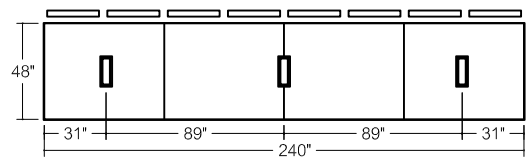

**03R48X240**  
18 Person Table

# Rectangular Conference Tables

## 48" Deep Tops Veneer Top

Base price includes "ON" - open leg, no metal trim, SL finish on leg and trim. "OT" - open leg, w/ metal trim is an upcharge listed below.

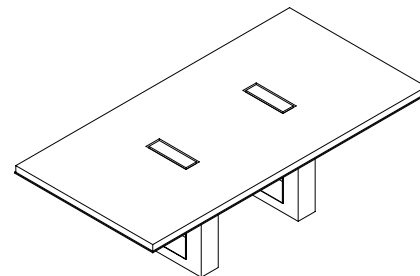

D	W	Pattern No.	T1__ Top	T2__ Top	PM01/ PM02 Edge Upcharge	PM03 Edge Upcharge	AU__ Edge Upcharge	SL__ Lower Layer	T__ Lower Layer	HG__ Lower Layer
48"	72"	<b>03R48X72</b>	\$17,355	\$18,092	\$940	\$940	\$2,292	\$369	\$588	\$646
48"	84"	<b>03R48X84</b>	18,631	19,489	1,465	1,465	2,523	442	669	737
48"	96"	<b>03R48X96</b>	19,596	20,576	1,465	1,465	2,751	462	696	769
48"	108"	<b>03R48X108</b>	21,300	22,402	1,465	1,465	2,981	506	771	850
48"	120"	<b>03R48X120</b>	22,504	23,731	1,527	1,527	3,210	662	881	968
48"	132"	<b>03R48X132</b>	28,118	29,467	1,528	1,528	3,439	669	941	1,036
48"	144"	<b>03R48X144</b>	29,520	30,991	1,527	1,527	3,669	684	1,000	1,098
48"	156"	<b>03R48X156</b>	30,437	32,031	1,527	1,527	3,899	706	1,007	1,109
48"	168"	<b>03R48X168</b>	32,071	33,787	2,513	2,513	4,128	771	1,110	1,222
48"	180"	<b>03R48X180</b>	33,076	34,556	2,513	2,513	4,356	816	1,226	1,350
48"	192"	<b>03R48X192</b>	38,232	40,195	2,513	2,513	4,587	888	1,255	1,381
48"	204"	<b>03R48X204</b>	39,275	41,361	2,513	2,513	4,816	933	1,322	1,454
48"	216"	<b>03R48X216</b>	40,310	42,517	2,513	2,513	5,044	979	1,397	1,537
48"	228"	<b>03R48X228</b>	41,380	43,711	2,513	2,513	5,274	991	1,469	1,617
48"	240"	<b>03R48X240</b>	42,397	44,849	2,513	2,513	5,503	1,043	1,579	1,737

### Base and Base Trim Upcharges

# of bases	T1__ Base	T2__ Base	HG__ Base	OT (for MC Base Metal)	PM01/PM02 Base Metal	PM03 Base Metal
2 base	\$1,001	\$2,098	\$4,581	\$3,975	\$5,347	\$6,682
3 base	1,502	3,147	6,872	5,960	8,021	10,025

Order Code	Specification Information	Refer To Accessories Section	Pricing Tiers
Example: <b>03R48X72-T003-PM01-MC01-SL01-SL01-UCO</b>	<b>To order please specify pattern number including:</b>	Please refer to Accessories section, <a href="#">page 213</a> for power details.	Please refer to Materials and Finish <a href="#">page 9</a> for specification details.
<b>03</b> Highline 50 Collection	1. Top finish	<b>Grommet options available in these finishes:</b>	T1 and T2 pricing includes powder coated base finish.
<b>R</b> Rectangular	2. Base Option	Powder coated	There is an upcharge for plated base finishes as highlighted above.
<b>48</b> Depth	3. Edge Opt./Finish (only applies if trim type is metal or leather)	Premium (Polished Chrome, Satin Nickel or Oil Rubbed Bronze)	For additional stone options and pricing please contact your sales representative."
<b>72</b> Width	4. Lower Layer Finish	<b>Power Box Options</b>	
<b>T003</b> Top Finish	5. Base Finish	<b>Code: Description:</b>	
<b>PM01</b> Base Option	6. Power box option	NP No Power	
<b>MC01</b> Edge Option/Finish	7. Table-top power finish (only applies if table-top power is selected)	UCO Undermount	
<b>SL01</b> Lower Layer Finish	Trim Type	T1E Tabletop 1-Sided Lid	
<b>SL01</b> Base Finish	N = No trim	T2C Tabletop 2-Sided Lid	
<b>UCO</b> Undermount	M = Metal (available in Premium and Powder Coat finishes)	<b>Must select Wire Management Column and Finish:</b>	
	L = Leather	Powder coated	
		Premium (Polished Chrome, Satin Nickel or Oil Rubbed Bronze)	

# Rectangular Conference Tables

## 48" Deep Tops Glass Top

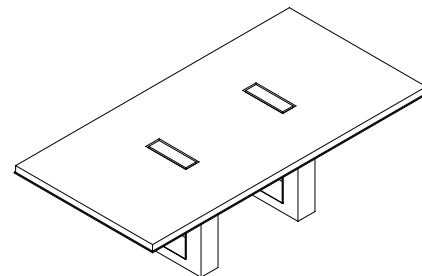

Base price includes "ON" - open leg, no metal trim, SL finish on leg and trim. "OT" - open leg, w/ metal trim is an upcharge listed below.

D	W	Pattern No.	GC__ Top	GE__ Top	PM01/ PM02 Edge Upcharge	PM03 Edge Upcharge	AU__ Edge Upcharge	SL__ Lower Layer	T__ Lower Layer	HG__ Lower Layer
48"	72"	<b>03R48X72</b>	\$21,389	\$22,056	\$940	\$940	\$2,292	\$369	\$588	\$646
48"	84"	<b>03R48X84</b>	23,267	24,047	1,465	1,465	2,523	442	669	737
48"	96"	<b>03R48X96</b>	24,825	25,715	1,465	1,465	2,751	462	696	769
48"	108"	<b>03R48X108</b>	27,152	28,152	1,465	1,465	2,981	506	771	850
48"	120"	<b>03R48X120</b>	28,957	30,068	1,527	1,527	3,210	662	881	968
48"	132"	<b>03R48X132</b>	35,357	36,580	1,528	1,528	3,439	669	941	1,036
48"	144"	<b>03R48X144</b>	37,369	38,703	1,527	1,527	3,669	684	1,000	1,098
48"	156"	<b>03R48X156</b>	38,875	40,321	1,527	1,527	3,899	706	1,007	1,109
48"	168"	<b>03R48X168</b>	41,129	42,685	2,513	2,513	4,128	771	1,110	1,222
48"	180"	<b>03R48X180</b>	42,728	44,395	2,513	2,513	4,356	816	1,226	1,350
48"	192"	<b>03R48X192</b>	48,650	50,430	2,513	2,513	4,587	888	1,255	1,381
48"	204"	<b>03R48X204</b>	50,288	52,179	2,513	2,513	4,816	933	1,322	1,454
48"	216"	<b>03R48X216</b>	51,915	53,915	2,513	2,513	5,044	979	1,397	1,537
48"	228"	<b>03R48X228</b>	53,581	55,692	2,513	2,513	5,274	991	1,469	1,617
48"	240"	<b>03R48X240</b>	55,192	57,415	2,513	2,513	5,503	1,043	1,579	1,737

### Base and Base Trim Upcharges

# of bases	T1__ Base	T2__ Base	HG__ Base	OT (for MC Base Metal)	PM01/PM02 Base Metal	PM03 Base Metal
2 base	\$1,001	\$2,098	\$4,581	\$3,975	\$5,347	\$6,682
3 base	1,502	3,147	6,872	5,960	8,021	10,025

Order Code	Specification Information	Refer To Accessories Section	Pricing Tiers
Example: <b>03R48X72-GE01-PM01-MC01-SL01-SL01-UCO</b>	<b>To order please specify pattern number including:</b>	Please refer to Accessories section, <a href="#">page 213</a> for power details.	Please refer to Materials and Finish <a href="#">page 9</a> for specification details.
<b>03</b> Highline 50 Collection	1. Top finish	<b>Grommet options available in these finishes:</b>	T1 and T2 pricing includes powder coated base finish.
<b>R</b> Rectangular	2. Base Option	Powder coated	There is an upcharge for plated base finishes as highlighted above.
<b>48</b> Depth	3. Edge Opt./Finish (only applies if trim type is metal or leather)	Premium (Polished Chrome, Satin Nickel or Oil Rubbed Bronze)	For additional stone options and pricing please contact your sales representative."
<b>72</b> Width	4. Lower Layer Finish	<b>Power Box Options</b>	
<b>GE01</b> Top Finish	5. Base Finish	<b>Code: Description:</b>	
<b>PM01</b> Base Option	6. Power box option	NP No Power	
<b>MC01</b> Edge Option/Finish	7. Table-top power finish (only applies if table-top power is selected)	UCO Undermount	
<b>SL01</b> Lower Layer Finish	Trim Type	T1E Tabletop 1-Sided Lid	
<b>SL01</b> Base Finish	N = No trim	T2C Tabletop 2-Sided Lid	
<b>UCO</b> Undermount	M = Metal (available in Premium and Powder Coat finishes)	<b>Must select Wire Management Column and Finish:</b>	
	L = Leather	Powder coated	
		Premium (Polished Chrome, Satin Nickel or Oil Rubbed Bronze)	

# Rectangular Conference Tables

## 48" Deep Tops Corian Top

Base price includes "ON" - open leg, no metal trim, SL finish on leg and trim. "OT" - open leg, w/ metal trim is an upcharge listed below.

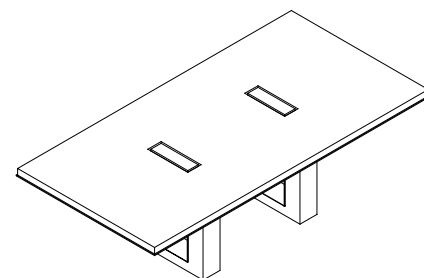

D	W	Pattern No.	CS01 Top	PM01/ PM02 Edge Upcharge	PM03 Edge Upcharge	AU__ Edge Upcharge	SL__ Lower Layer	T__ Lower Layer	HG__ Lower Layer
48"	72"	<b>03R48X72</b>	\$21,993	\$940	\$940	\$2,292	\$369	\$588	\$646
48"	84"	<b>03R48X84</b>	24,043	1,465	1,465	2,523	442	669	737
48"	96"	<b>03R48X96</b>	25,780	1,465	1,465	2,751	462	696	769
48"	108"	<b>03R48X108</b>	28,258	1,465	1,465	2,981	506	771	850
48"	120"	<b>03R48X120</b>	30,235	1,527	1,527	3,210	662	881	968
48"	132"	<b>03R48X132</b>	36,622	1,528	1,528	3,439	669	941	1,036
48"	144"	<b>03R48X144</b>	38,797	1,527	1,527	3,669	684	1,000	1,098
48"	156"	<b>03R48X156</b>	40,489	1,527	1,527	3,899	706	1,007	1,109
48"	168"	<b>03R48X168</b>	42,895	2,513	2,513	4,128	771	1,110	1,222
48"	180"	<b>03R48X180</b>	44,674	2,513	2,513	4,356	816	1,226	1,350
48"	192"	<b>03R48X192</b>	50,602	2,513	2,513	4,587	888	1,255	1,381
48"	204"	<b>03R48X204</b>	52,419	2,513	2,513	4,816	933	1,322	1,454
48"	216"	<b>03R48X216</b>	54,226	2,513	2,513	5,044	979	1,397	1,537
48"	228"	<b>03R48X228</b>	56,069	2,513	2,513	5,274	991	1,469	1,617
48"	240"	<b>03R48X240</b>	57,860	2,513	2,513	5,503	1,043	1,579	1,737

### Base and Base Trim Upcharges

# of bases	T1__ Base	T2__ Base	HG__ Base	OT (for MC Base Metal)	PM01/PM02 Base Metal	PM03 Base Metal
2 base	\$1,001	\$2,098	\$4,581	\$3,975	\$5,347	\$6,682
3 base	1,502	3,147	6,872	5,960	8,021	10,025

Order Code	Specification Information	Refer To Accessories Section	Pricing Tiers
Example: <b>03R48X72-CS01-PM01-MC01-SL01-SL01-UCO</b>	<b>To order please specify pattern number including:</b>	Please refer to Accessories section, <a href="#">page 213</a> for power details.	Please refer to Materials and Finish <a href="#">page 9</a> for specification details.
<b>03</b> Highline 50 Collection	1. Top finish	<b>Grommet options available in these finishes:</b>	T1 and T2 pricing includes powder coated base finish.
<b>R</b> Rectangular	2. Base Option	Powder coated	There is an upcharge for plated base finishes as highlighted above.
<b>48</b> Depth	3. Edge Opt./Finish (only applies if trim type is metal or leather)	Premium (Polished Chrome, Satin Nickel or Oil Rubbed Bronze)	For additional stone options and pricing please contact your sales representative."
<b>72</b> Width	4. Lower Layer Finish	<b>Power Box Options</b>	
<b>CS01</b> Top Finish	5. Base Finish	<b>Code: Description:</b>	
<b>PM01</b> Base Option	6. Power box option	NP No Power	
<b>MC01</b> Edge Option/Finish	7. Table-top power finish (only applies if table-top power is selected)	UCO Undermount	
<b>SL01</b> Lower Layer Finish	Trim Type	T1E Tabletop 1-Sided Lid	
<b>SL01</b> Base Finish	N = No trim	T2C Tabletop 2-Sided Lid	
<b>UCO</b> Undermount	M = Metal (available in Premium and Powder Coat finishes)	<b>Must select Wire Management Column and Finish:</b>	
	L = Leather	Powder coated	
		Premium (Polished Chrome, Satin Nickel or Oil Rubbed Bronze)	



# Rectangular Conference Tables

## 54" Deep Tops

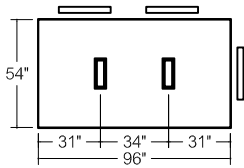
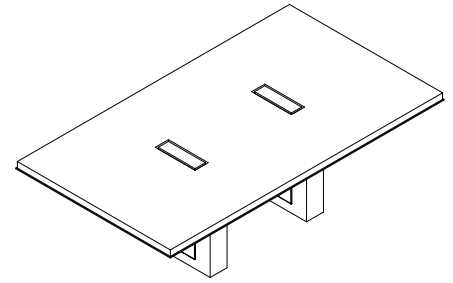

**03R54X96**

6 Person Table

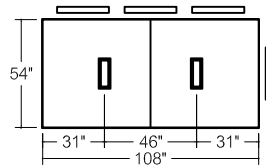

**03R54X108**

8 Person Table

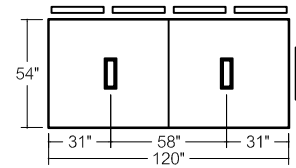

**03R54X120**

10 Person Table

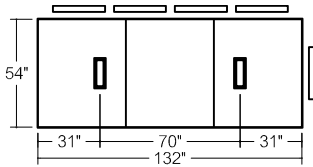

**03R54X132**

10 Person Table

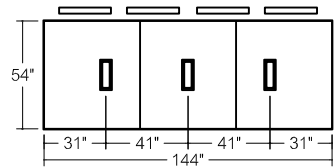

**03R54X144**

10 Person Table

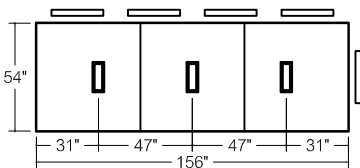

**03R54X156**

10 Person Table

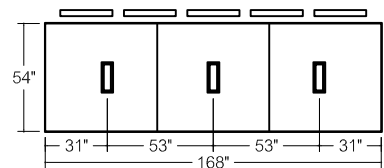

**03R54X168**

12 Person Table



# Rectangular Conference Tables

## 54" Deep Tops

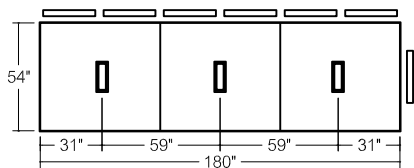
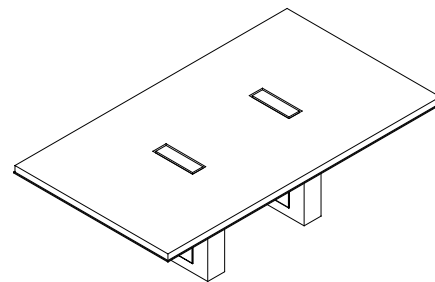

**03R54X180**  
14 Person Table

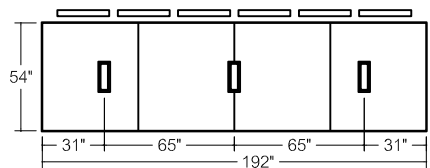

**03R54X192**  
14 Person Table

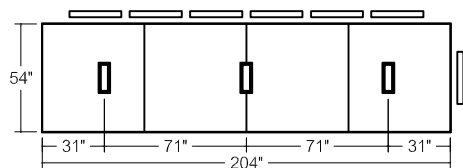

**03R54X204**  
14 Person Table

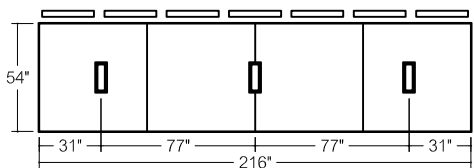

**03R54X216**  
16 Person Table

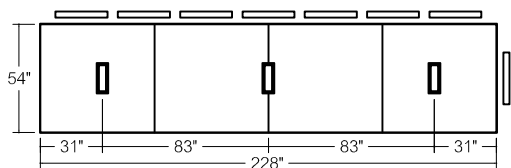

**03R54X228**  
16 Person Table

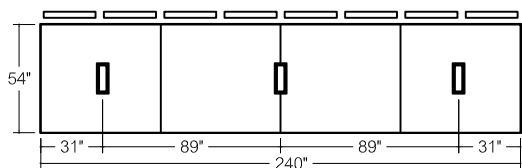

**03R54X240**  
18 Person Table

# Rectangular Conference Tables

## 54" Deep Tops Veneer Top

Base price includes "ON" - open leg, no metal trim, SL finish on leg and trim. "OT" - open leg, w/ metal trim is an upcharge listed below.

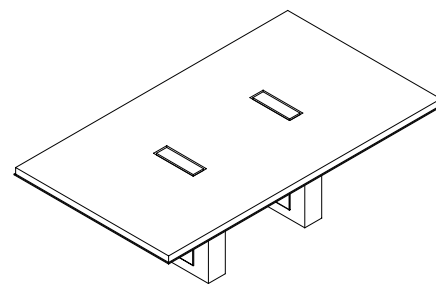

D	W	Pattern No.	T1__ Top	T2__ Top	PM01/ PM02 Edge Upcharge	PM03 Edge Upcharge	AU__ Edge Upcharge	SL__ Lower Layer	T__ Lower Layer	HG__ Lower Layer
54"	96"	<b>03R54X96</b>	\$22,101	\$23,204	\$940	\$940	\$2,292	\$369	\$588	\$646
54"	108"	<b>03R54X108</b>	24,022	25,264	1,465	1,465	2,523	442	669	737
54"	120"	<b>03R54X120</b>	25,288	26,667	1,465	1,465	2,751	462	696	769
54"	132"	<b>03R54X132</b>	31,693	33,210	1,465	1,465	2,981	506	771	850
54"	144"	<b>03R54X144</b>	33,271	34,927	1,527	1,527	3,210	662	881	968
54"	156"	<b>03R54X156</b>	34,322	36,116	1,528	1,528	3,439	669	941	1,036
54"	168"	<b>03R54X168</b>	36,161	38,094	1,527	1,527	3,669	684	1,000	1,098
54"	180"	<b>03R54X180</b>	37,307	39,364	1,527	1,527	3,899	706	1,007	1,109
54"	192"	<b>03R54X192</b>	43,099	45,306	2,513	2,513	4,128	771	1,110	1,222
54"	204"	<b>03R54X204</b>	44,275	46,621	2,513	2,513	4,356	816	1,226	1,350
54"	216"	<b>03R54X216</b>	45,436	47,918	2,513	2,513	4,587	888	1,255	1,381
54"	228"	<b>03R54X228</b>	46,643	49,263	2,513	2,513	4,816	933	1,322	1,454
54"	240"	<b>03R54X240</b>	47,789	50,548	2,513	2,513	5,044	979	1,397	1,537

### Base and Base Trim Upcharges

# of bases	T1__ Base	T2__ Base	HG__ Base	OT (for MC Base Metal)	PM01/PM02 Base Metal	PM03 Base Metal
2 base	\$1,001	\$2,098	\$4,581	\$3,975	\$5,347	\$6,682
3 base	1,502	3,147	6,872	5,960	8,021	10,025

Order Code	Specification Information	Refer To Accessories Section	Pricing Tiers
Example: <b>03R54X96-T003-PM01-MC01-SL01-SL01-UCO</b>	<b>To order please specify pattern number including:</b>	Please refer to Accessories section, <a href="#">page 213</a> for power details.	Please refer to Materials and Finish <a href="#">page 9</a> for specification details.
<b>03</b> Highline 50 Collection	1. Top finish	<b>Grommet options available in these finishes:</b>	T1 and T2 pricing includes powder coated base finish.
<b>R</b> Rectangular	2. Base Option	Powder coated	There is an upcharge for plated base finishes as highlighted above.
<b>54</b> Depth	3. Edge Opt./Finish (only applies if trim type is metal or leather)	Premium (Polished Chrome, Satin Nickel or Oil Rubbed Bronze)	For additional stone options and pricing please contact your sales representative."
<b>96</b> Width	4. Lower Layer Finish	<b>Power Box Options</b>	
<b>T003</b> Top Finish	5. Base Finish	<b>Code: Description:</b>	
<b>PM01</b> Base Option	6. Power box option	NP No Power	
<b>MC01</b> Edge Option/Finish	7. Table-top power finish (only applies if table-top power is selected)	UCO Undermount	
<b>SL01</b> Lower Layer Finish	Trim Type	T1E Tabletop 1-Sided Lid	
<b>SL01</b> Base Finish	N = No trim	T2C Tabletop 2-Sided Lid	
<b>UCO</b> Undermount	M = Metal (available in Premium and Powder Coat finishes)	<b>Must select Wire Management Column and Finish:</b>	
	L = Leather	Powder coated	
		Premium (Polished Chrome, Satin Nickel or Oil Rubbed Bronze)	

# Rectangular Conference Tables

## 54" Deep Tops Glass Top

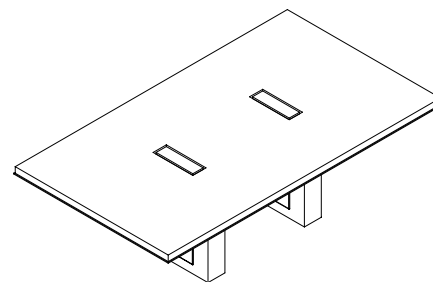

Base price includes "ON" - open leg, no metal trim, SL finish on leg and trim. "OT" - open leg, w/ metal trim is an upcharge listed below.

D	W	Pattern No.	GC__ Top	GE__ Top	PM01/ PM02 Edge Upcharge	PM03 Edge Upcharge	AU__ Edge Upcharge	SL__ Lower Layer	T__ Lower Layer	HG__ Lower Layer
54"	96"	<b>03R54X96</b>	\$27,987	\$28,986	\$940	\$940	\$2,292	\$369	\$588	\$646
54"	108"	<b>03R54X108</b>	30,610	31,734	1,465	1,465	2,523	442	669	737
54"	120"	<b>03R54X120</b>	32,546	33,795	1,465	1,465	2,751	462	696	769
54"	132"	<b>03R54X132</b>	39,839	41,215	1,465	1,465	2,981	506	771	850
54"	144"	<b>03R54X144</b>	42,103	42,103	1,527	1,527	3,210	662	881	968
54"	156"	<b>03R54X156</b>	43,819	45,444	1,528	1,528	3,439	669	941	1,036
54"	168"	<b>03R54X168</b>	46,355	48,105	1,527	1,527	3,669	684	1,000	1,098
54"	180"	<b>03R54X180</b>	48,154	50,031	1,527	1,527	3,899	706	1,007	1,109
54"	192"	<b>03R54X192</b>	54,824	56,823	2,513	2,513	4,128	771	1,110	1,222
54"	204"	<b>03R54X204</b>	56,667	58,795	2,513	2,513	4,356	816	1,226	1,350
54"	216"	<b>03R54X216</b>	58,496	60,749	2,513	2,513	4,587	888	1,255	1,381
54"	228"	<b>03R54X228</b>	60,373	62,749	2,513	2,513	4,816	933	1,322	1,454
54"	240"	<b>03R54X240</b>	62,186	64,687	2,513	2,513	5,044	979	1,397	1,537

### Base and Base Trim Upcharges

# of bases	T1__ Base	T2__ Base	HG__ Base	OT (for MC Base Metal)	PM01/PM02 Base Metal	PM03 Base Metal
2 base	\$1,001	\$2,098	\$4,581	\$3,975	\$5,347	\$6,682
3 base	1,502	3,147	6,872	5,960	8,021	10,025

Order Code	Specification Information	Refer To Accessories Section	Pricing Tiers
Example: <b>03R54X96-GE01-PM01-MC01-SL01-SL01-UCO</b>	<b>To order please specify pattern number including:</b>	Please refer to Accessories section, <a href="#">page 213</a> for power details.	Please refer to Materials and Finish <a href="#">page 9</a> for specification details.
<b>03</b> Highline 50 Collection	1. Top finish	<b>Grommet options available in these finishes:</b>	T1 and T2 pricing includes powder coated base finish.
<b>R</b> Rectangular	2. Base Option	Powder coated	There is an upcharge for plated base finishes as highlighted above.
<b>54</b> Depth	3. Edge Opt./Finish (only applies if trim type is metal or leather)	Premium (Polished Chrome, Satin Nickel or Oil Rubbed Bronze)	For additional stone options and pricing please contact your sales representative."
<b>96</b> Width	4. Lower Layer Finish	<b>Power Box Options</b>	
<b>GE01</b> Top Finish	5. Base Finish	<b>Code: Description:</b>	
<b>PM01</b> Base Option	6. Power box option	NP No Power	
<b>MC01</b> Edge Option/Finish	7. Table-top power finish (only applies if table-top power is selected)	UCO Undermount	
<b>SL01</b> Lower Layer Finish	Trim Type	T1E Tabletop 1-Sided Lid	
<b>SL01</b> Base Finish	N = No trim	T2C Tabletop 2-Sided Lid	
<b>UCO</b> Undermount	M = Metal (available in Premium and Powder Coat finishes)	<b>Must select Wire Management</b>	
	L = Leather	<b>Column and Finish:</b>	
		Powder coated	
		Premium (Polished Chrome, Satin Nickel or Oil Rubbed Bronze)	

# Rectangular Conference Tables

## 54" Deep Tops Corian Top

Base price includes "ON" - open leg, no metal trim, SL finish on leg and trim. "OT" - open leg, w/ metal trim is an upcharge listed below.

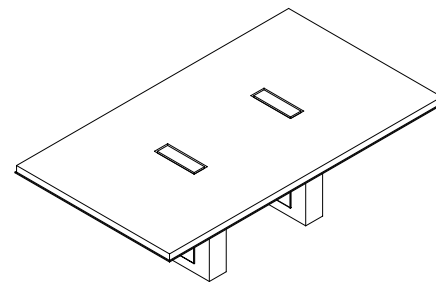

D	W	Pattern No.	CS01 Top	PM01/ PM02 Edge Upcharge	PM03 Edge Upcharge	AU__ Edge Upcharge	SL__ Lower Layer	T__ Lower Layer	HG__ Lower Layer
54"	96"	<b>03R54X96</b>	\$29,060	\$1,499	\$940	\$940	\$521	\$783	\$863
54"	108"	<b>03R54X108</b>	31,850	1,499	1,465	1,465	569	868	956
54"	120"	<b>03R54X120</b>	33,986	1,499	1,465	1,465	742	991	1,092
54"	132"	<b>03R54X132</b>	41,260	1,708	1,465	1,465	752	1,058	1,164
54"	144"	<b>03R54X144</b>	43,707	1,708	1,527	1,527	769	1,124	1,236
54"	156"	<b>03R54X156</b>	46,109	1,708	1,528	1,528	793	1,134	1,245
54"	168"	<b>03R54X168</b>	48,339	2,547	1,527	1,527	867	1,246	1,371
54"	180"	<b>03R54X180</b>	50,342	2,547	1,527	1,527	891	1,379	1,517
54"	192"	<b>03R54X192</b>	57,018	2,547	2,513	2,513	954	1,413	1,554
54"	204"	<b>03R54X204</b>	59,062	2,547	2,513	2,513	1,048	1,490	1,636
54"	216"	<b>03R54X216</b>	61,092	2,547	2,513	2,513	1,098	1,571	1,728
54"	228"	<b>03R54X228</b>	63,168	2,547	2,513	2,513	1,115	1,653	1,820
54"	240"	<b>03R54X240</b>	65,183	2,547	2,513	2,513	1,174	1,778	1,954

### Base and Base Trim Upcharges

# of bases	T1__ Base	T2__ Base	HG__ Base	OT (for MC Base Metal)	PM01/PM02 Base Metal	PM03 Base Metal
2 base	\$1,001	\$2,098	\$4,581	\$3,975	\$5,347	\$6,682
3 base	1,502	3,147	6,872	5,960	8,021	10,025

Order Code	Specification Information	Refer To Accessories Section	Pricing Tiers
Example: <b>03R54X96-CS01-PM01-MC01-SL01-SLO1-UCO</b>	<b>To order please specify pattern number including:</b>	Please refer to Accessories section, <b>page 213</b> for power details.	Please refer to Materials and Finish <b>page 9</b> for specification details.
<b>03</b> Highline 50 Collection	1. Top finish	<b>Grommet options available in these finishes:</b>	T1 and T2 pricing includes powder coated base finish.
<b>R</b> Rectangular	2. Base Option	Powder coated	There is an upcharge for plated base finishes as highlighted above.
<b>54</b> Depth	3. Edge Opt./Finish (only applies if trim type is metal or leather)	Premium (Polished Chrome, Satin Nickel or Oil Rubbed Bronze)	For additional stone options and pricing please contact your sales representative."
<b>96</b> Width	4. Lower Layer Finish	<b>Power Box Options</b>	
<b>CS01</b> Top Finish	5. Base Finish	<b>Code: Description:</b>	
<b>PM01</b> Base Option	6. Power box option	NP No Power	
<b>MC01</b> Edge Option/Finish	7. Table-top power finish (only applies if table-top power is selected)	UCO Undermount	
<b>SLO1</b> Lower Layer Finish	Trim Type	T1E Tabletop 1-Sided Lid	
<b>SLO1</b> Base Finish	N = No trim	T2C Tabletop 2-Sided Lid	
<b>UCO</b> Undermount	M = Metal (available in Premium and Powder Coat finishes)	<b>Must select Wire Management Column and Finish:</b>	
	L = Leather	Powder coated	
		Premium (Polished Chrome, Satin Nickel or Oil Rubbed Bronze)	



# Rectangular Conference Tables

## 60" Deep Tops

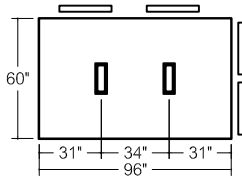
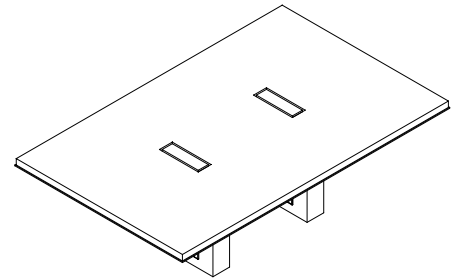

**03R60X96**  
8 Person Table

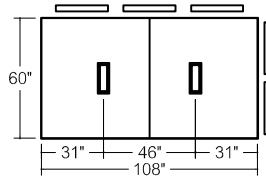

**03R60X108**  
10 Person Table

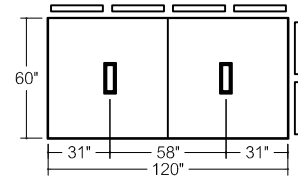

**03R60X120**  
12 Person Table

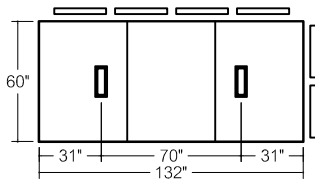

**03R60X132**  
12 Person Table

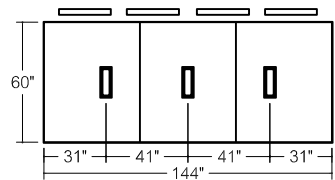

**03R60X144**  
12 Person Table

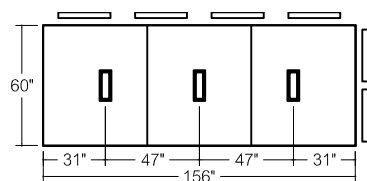

**03R60X156**  
12 Person Table

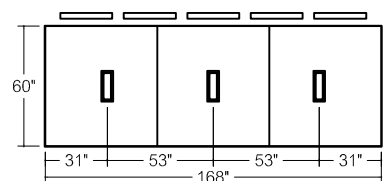

**03R60X168**  
14 Person Table

# Rectangular Conference Tables

60" Deep Tops

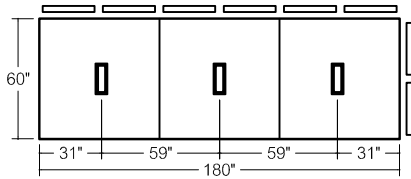
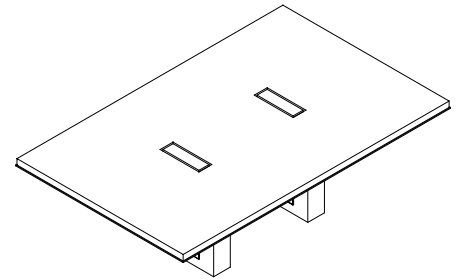

**03R60X180**

16 Person Table

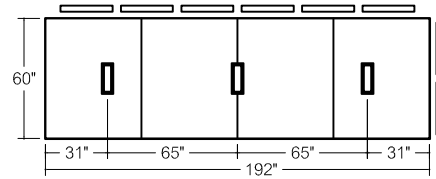

**03R60X192**

16 Person Table

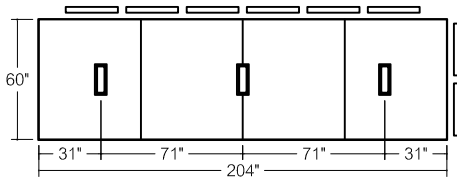

**03R60X204**

16 Person Table

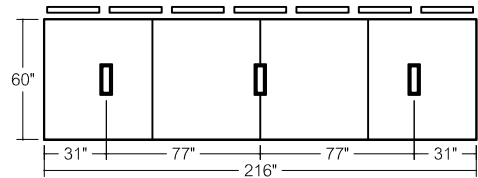

**03R60X216**

18 Person Table

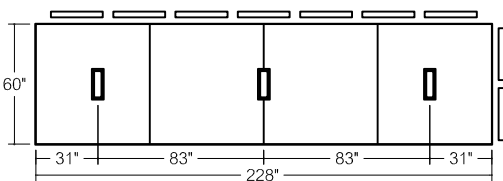

**03R60X228**

18 Person Table

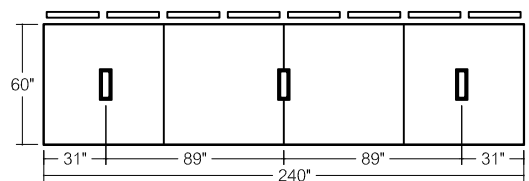

**03R60X240**

20 Person Table

# Rectangular Conference Tables

## 60" Deep Tops Veneer Top

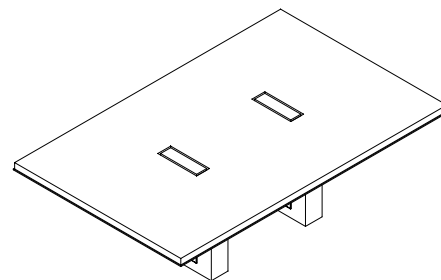

Base price includes "ON" - open leg, no metal trim, SL finish on leg and trim. "OT" - open leg, w/ metal trim is an upcharge listed below.

D	W	Pattern No.	T1__ Top	T2__ Top	PM01/ PM02 Edge Upcharge	PM03 Edge Upcharge	AU__ Edge Upcharge	SL__ Lower Layer	T__ Lower Layer	HG__ Lower Layer
60"	96"	<b>03R60X96</b>	\$22,922	\$24,148	\$1,519	\$1,519	\$2,981	\$514	\$801	\$881
60"	108"	<b>03R60X108</b>	24,182	25,562	1,519	1,519	3,210	609	925	1,018
60"	120"	<b>03R60X120</b>	25,630	27,164	1,519	1,519	3,439	646	963	1,059
60"	132"	<b>03R60X132</b>	31,852	33,539	1,709	1,709	3,669	741	1,072	1,178
60"	144"	<b>03R60X144</b>	33,472	35,313	1,709	1,709	3,899	822	1,139	1,253
60"	156"	<b>03R60X156</b>	34,782	36,773	1,709	1,709	4,128	859	1,221	1,341
60"	168"	<b>03R60X168</b>	36,526	38,673	2,560	2,560	4,356	925	1,285	1,414
60"	180"	<b>03R60X180</b>	37,856	40,154	2,560	2,560	4,587	948	1,328	1,464
60"	192"	<b>03R60X192</b>	43,461	45,913	2,560	2,560	4,816	1,020	1,448	1,594
60"	204"	<b>03R60X204</b>	44,743	47,351	2,560	2,560	5,044	1,081	1,527	1,680
60"	216"	<b>03R60X216</b>	46,079	48,841	2,560	2,560	5,274	1,132	1,552	1,723
60"	228"	<b>03R60X228</b>	47,362	50,275	2,560	2,560	5,503	1,191	1,690	1,860
60"	240"	<b>03R60X240</b>	48,650	51,717	2,560	2,560	5,732	1,249	1,770	1,949

### Base and Base Trim Upcharges

# of bases	T1__ Base	T2__ Base	HG__ Base	OT (for MC Base Metal)	PM01/PM02 Base Metal	PM03 Base Metal
2 base	\$1,001	\$2,098	\$4,581	\$3,975	\$5,347	\$6,682
3 base	1,502	3,147	6,872	5,960	8,021	10,025

Order Code	Specification Information	Refer To Accessories Section	Pricing Tiers
Example: <b>03R60X96-T003-PM01-MC01-SL01-SL01-UCO</b>	<b>To order please specify pattern number including:</b>	Please refer to Accessories section, <b>page 213</b> for power details.	Please refer to Materials and Finish <b>page 9</b> for specification details.
<b>03</b> Highline 50 Collection	1. Top finish	<b>Grommet options available in these finishes:</b>	T1 and T2 pricing includes powder coated base finish.
<b>R</b> Rectangular	2. Base Option	Powder coated	There is an upcharge for plated base finishes as highlighted above.
<b>60</b> Depth	3. Edge Opt./Finish (only applies if trim type is metal or leather)	Premium (Polished Chrome, Satin Nickel or Oil Rubbed Bronze)	For additional stone options and pricing please contact your sales representative."
<b>96</b> Width	4. Lower Layer Finish	<b>Power Box Options</b>	
<b>T003</b> Top Finish	5. Base Finish	<b>Code: Description:</b>	
<b>PM01</b> Base Option	6. Power box option	NP No Power	
<b>MC01</b> Edge Option/Finish	7. Table-top power finish (only applies if table-top power is selected)	UCO Undermount	
<b>SL01</b> Lower Layer Finish	Trim Type	T1E Tabletop 1-Sided Lid	
<b>SL01</b> Base Finish	N = No trim	T2C Tabletop 2-Sided Lid	
<b>UCO</b> Undermount	M = Metal (available in Premium and Powder Coat finishes)	<b>Must select Wire Management Column and Finish:</b>	
	L = Leather	Powder coated	
		Premium (Polished Chrome, Satin Nickel or Oil Rubbed Bronze)	



# Rectangular Conference Tables

## 60" Deep Tops Glass Top

Base price includes "ON" - open leg, no metal trim, SL finish on leg and trim. "OT" - open leg, w/ metal trim is an upcharge listed below.

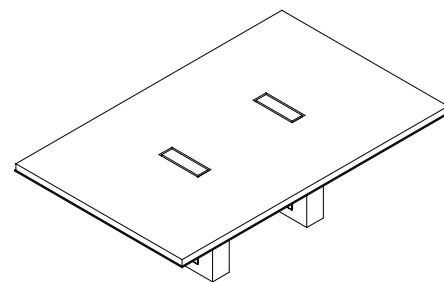

D	W	Pattern No.	GC__ Top	GE__ Top	PM01/ PM02 Edge Upcharge	PM03 Edge Upcharge	AU__ Edge Upcharge	SL__ Lower Layer	T__ Lower Layer	HG__ Lower Layer
60"	96"	<b>03R60X96</b>	\$29,392	\$30,504	\$1,519	\$1,519	\$2,981	\$514	\$801	\$881
60"	108"	<b>03R60X108</b>	31,393	32,645	1,519	1,519	3,210	609	925	1,018
60"	120"	<b>03R60X120</b>	33,591	34,980	1,519	1,519	3,439	646	963	1,059
60"	132"	<b>03R60X132</b>	40,763	42,291	1,709	1,709	3,669	741	1,072	1,178
60"	144"	<b>03R60X144</b>	43,140	44,807	1,709	1,709	3,899	822	1,139	1,253
60"	156"	<b>03R60X156</b>	45,191	46,997	1,709	1,709	4,128	859	1,221	1,341
60"	168"	<b>03R60X168</b>	47,698	49,643	2,560	2,560	4,356	925	1,285	1,414
60"	180"	<b>03R60X180</b>	49,770	51,853	2,560	2,560	4,587	948	1,328	1,464
60"	192"	<b>03R60X192</b>	56,303	58,526	2,560	2,560	4,816	1,020	1,448	1,594
60"	204"	<b>03R60X204</b>	58,325	60,687	2,560	2,560	5,044	1,081	1,527	1,680
60"	216"	<b>03R60X216</b>	60,406	62,906	2,560	2,560	5,274	1,132	1,552	1,723
60"	228"	<b>03R60X228</b>	62,431	65,070	2,560	2,560	5,503	1,191	1,690	1,860
60"	240"	<b>03R60X240</b>	64,462	67,240	2,560	2,560	5,732	1,249	1,770	1,949

### Base and Base Trim Upcharges

# of bases	T1__ Base	T2__ Base	HG__ Base	OT (for MC Base Metal)	PM01/PM02 Base Metal	PM03 Base Metal
2 base	\$1,001	\$2,098	\$4,581	\$3,975	\$5,347	\$6,682
3 base	1,502	3,147	6,872	5,960	8,021	10,025

Order Code	Specification Information	Refer To Accessories Section	Pricing Tiers
Example: <b>03R60X96-GE01-PM01-MC01-SL01-SL01-UCO</b>	<b>To order please specify pattern number including:</b>	Please refer to Accessories section, <a href="#">page 213</a> for power details.	Please refer to Materials and Finish <a href="#">page 9</a> for specification details.
<b>03</b> Highline 50 Collection	1. Top finish	<b>Grommet options available in these finishes:</b>	T1 and T2 pricing includes powder coated base finish.
<b>R</b> Rectangular	2. Base Option	Powder coated	There is an upcharge for plated base finishes as highlighted above.
<b>60</b> Depth	3. Edge Opt./Finish (only applies if trim type is metal or leather)	Premium (Polished Chrome, Satin Nickel or Oil Rubbed Bronze)	For additional stone options and pricing please contact your sales representative."
<b>96</b> Width	4. Lower Layer Finish	<b>Power Box Options</b>	
<b>GE01</b> Top Finish	5. Base Finish	<b>Code: Description:</b>	
<b>PM01</b> Base Option	6. Power box option	NP No Power	
<b>MC01</b> Edge Option/Finish	7. Table-top power finish (only applies if table-top power is selected)	UCO Undermount	
<b>SL01</b> Lower Layer Finish	Trim Type	T1E Tabletop 1-Sided Lid	
<b>SL01</b> Base Finish	N = No trim	T2C Tabletop 2-Sided Lid	
<b>UCO</b> Undermount	M = Metal (available in Premium and Powder Coat finishes)	<b>Must select Wire Management Column and Finish:</b>	
	L = Leather	Powder coated	
		Premium (Polished Chrome, Satin Nickel or Oil Rubbed Bronze)	

# Rectangular Conference Tables

## 60" Deep Tops Corian Top

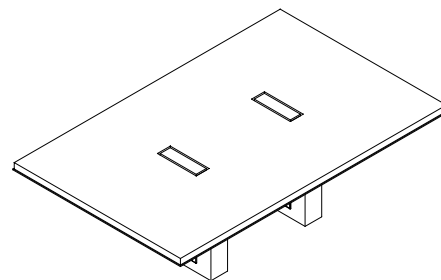

Base price includes "ON" - open leg, no metal trim, SL finish on leg and trim. "OT" - open leg, w/ metal trim is an upcharge listed below.

D	W	Pattern No.	CS01 Top	PM01/ PM02 Edge Upcharge	PM03 Edge Upcharge	AU__ Edge Upcharge	SL__ Lower Layer	T__ Lower Layer	HG__ Lower Layer
60"	96"	<b>03R60X96</b>	\$30,653	\$1,519	\$1,519	\$2,981	\$514	\$801	\$881
60"	108"	<b>03R60X108</b>	32,880	1,519	1,519	3,210	609	925	1,018
60"	120"	<b>03R60X120</b>	35,295	1,519	1,519	3,439	646	963	1,059
60"	132"	<b>03R60X132</b>	42,484	1,709	1,709	3,669	741	1,072	1,178
60"	144"	<b>03R60X144</b>	45,069	1,709	1,709	3,899	822	1,139	1,253
60"	156"	<b>03R60X156</b>	47,345	1,709	1,709	4,128	859	1,221	1,341
60"	168"	<b>03R60X168</b>	50,056	2,560	2,560	4,356	925	1,285	1,414
60"	180"	<b>03R60X180</b>	52,352	2,560	2,560	4,587	948	1,328	1,464
60"	192"	<b>03R60X192</b>	58,925	2,560	2,560	4,816	1,020	1,448	1,594
60"	204"	<b>03R60X204</b>	61,174	2,560	2,560	5,044	1,081	1,527	1,680
60"	216"	<b>03R60X216</b>	63,475	2,560	2,560	5,274	1,132	1,552	1,723
60"	228"	<b>03R60X228</b>	65,724	2,560	2,560	5,503	1,191	1,690	1,860
60"	240"	<b>03R60X240</b>	67,980	2,560	2,560	5,732	1,249	1,770	1,949

### Base and Base Trim Upcharges

# of bases	T1__ Base	T2__ Base	HG__ Base	OT (for MC Base Metal)	PM01/PM02 Base Metal	PM03 Base Metal
2 base	\$1,001	\$2,098	\$4,581	\$3,975	\$5,347	\$6,682
3 base	1,502	3,147	6,872	5,960	8,021	10,025

Order Code	Specification Information	Refer To Accessories Section	Pricing Tiers
Example: <b>03R60X96-CS01-PM01-MC01-SL01-SL01-UCO</b>	<b>To order please specify pattern number including:</b>	Please refer to Accessories section, <a href="#">page 213</a> for power details.	Please refer to Materials and Finish <a href="#">page 9</a> for specification details.
<b>03</b> Highline 50 Collection	1. Top finish	<b>Grommet options available in these finishes:</b>	T1 and T2 pricing includes powder coated base finish.
<b>R</b> Rectangular	2. Base Option	Powder coated	There is an upcharge for plated base finishes as highlighted above.
<b>60</b> Depth	3. Edge Opt./Finish (only applies if trim type is metal or leather)	Premium (Polished Chrome, Satin Nickel or Oil Rubbed Bronze)	For additional stone options and pricing please contact your sales representative."
<b>96</b> Width	4. Lower Layer Finish	<b>Power Box Options</b>	
<b>CS01</b> Top Finish	5. Base Finish	<b>Code: Description:</b>	
<b>PM01</b> Base Option	6. Power box option	NP No Power	
<b>MC01</b> Edge Option/Finish	7. Table-top power finish (only applies if table-top power is selected)	UCO Undermount	
<b>SL01</b> Lower Layer Finish	Trim Type	T1E Tabletop 1-Sided Lid	
<b>SL01</b> Base Finish	N = No trim	T2C Tabletop 2-Sided Lid	
<b>UCO</b> Undermount	M = Metal (available in Premium and Powder Coat finishes)	<b>Must select Wire Management Column and Finish:</b>	
	L = Leather	Powder coated	
		Premium (Polished Chrome, Satin Nickel or Oil Rubbed Bronze)	



# Rectangular Conference Tables

72" Deep Tops

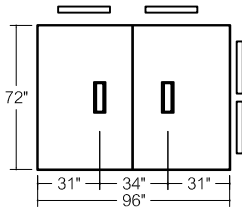
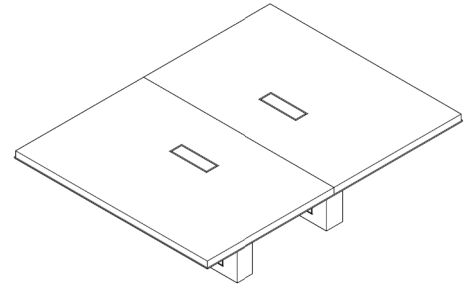

**03R72X96**

8 Person Table

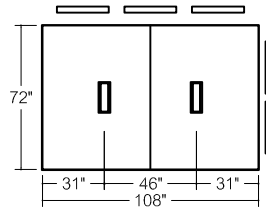

**03R72X108**

10 Person Table

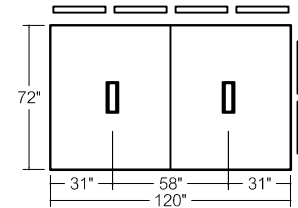

**03R72X120**

12 Person Table

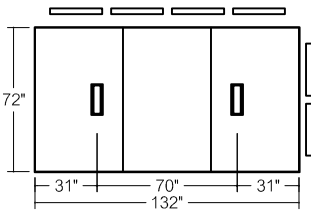

**03R72X132**

12 Person Table

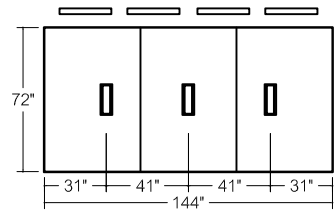

**03R72X144**

12 Person Table

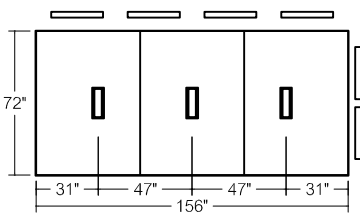

**03R72X156**

12 Person Table

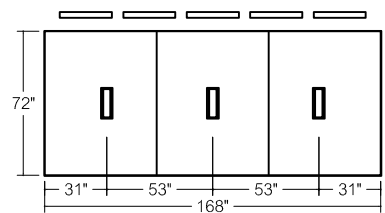

**03R72X168**

14 Person Table

# Rectangular Conference Tables

## 72" Deep Tops

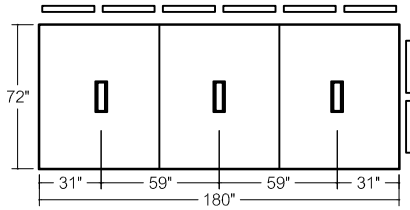
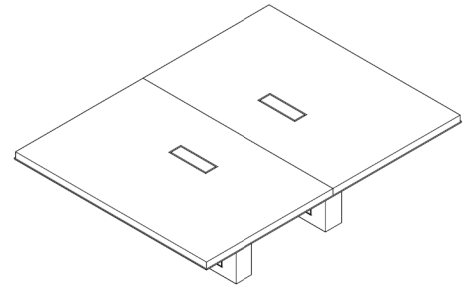

**03R72X180**  
16 Person Table

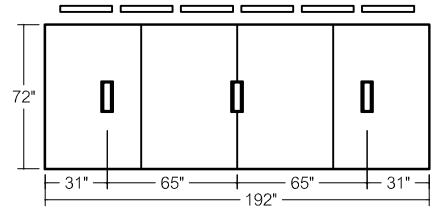

**03R72X192**  
16 Person Table

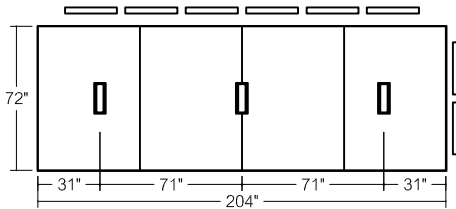

**03R72X204**  
16 Person Table

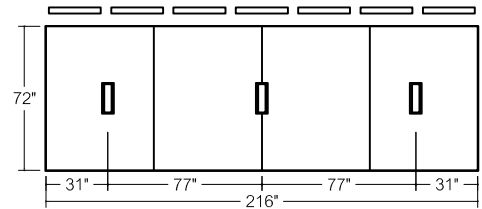

**03R72X216**  
18 Person Table

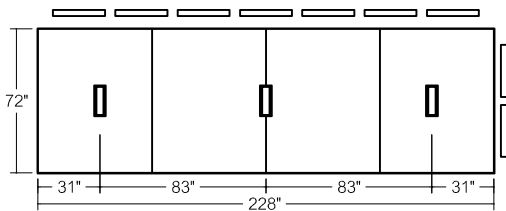

**03R72X228**  
18 Person Table

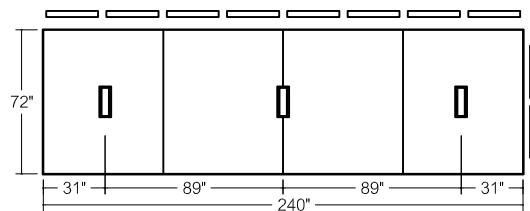

**03R72X240**  
20 Person Table

# Rectangular Conference Tables

## 72" Deep Tops Veneer Top

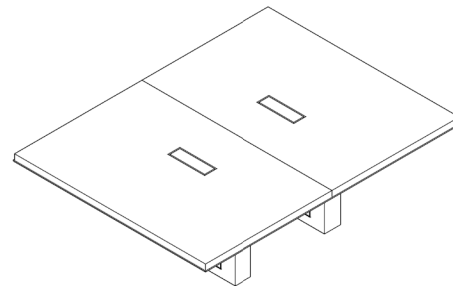

Base price includes "ON" - open leg, no metal trim, SL finish on leg and trim. "OT" - open leg, w/ metal trim is an upcharge listed below.

D	W	Pattern No.	T1__ Top	T2__ Top	PM01/ PM02 Edge Upcharge	PM03 Edge Upcharge	AU__ Edge Upcharge	SL__ Lower Layer	T__ Lower Layer	HG__ Lower Layer
72"	96"	<b>03R72X96</b>	\$25,052	\$26,523	\$1,634	\$1,634	\$3,210	\$607	\$862	\$950
72"	108"	<b>03R72X108</b>	26,589	28,244	1,634	1,634	3,439	690	1,020	1,124
72"	120"	<b>03R72X120</b>	28,269	30,109	1,634	1,634	3,669	758	1,116	1,228
72"	132"	<b>03R72X132</b>	34,788	36,812	1,731	1,731	3,764	831	1,152	1,269
72"	144"	<b>03R72X144</b>	36,705	38,913	1,731	1,731	4,128	847	1,173	1,290
72"	156"	<b>03R72X156</b>	38,211	40,604	1,731	1,731	4,356	986	1,344	1,478
72"	168"	<b>03R72X168</b>	40,229	42,805	2,560	2,560	4,587	1,043	1,448	1,594
72"	180"	<b>03R72X180</b>	41,782	44,542	2,560	2,560	4,816	1,072	1,537	1,690
72"	192"	<b>03R72X192</b>	47,660	50,602	2,560	2,560	5,044	1,152	1,623	1,785
72"	204"	<b>03R72X204</b>	49,274	52,269	2,560	2,560	5,274	1,255	1,711	1,883
72"	216"	<b>03R72X216</b>	50,786	54,097	2,560	2,560	5,503	1,316	1,801	1,979
72"	228"	<b>03R72X228</b>	52,332	55,827	2,560	2,560	5,732	1,373	1,881	2,070
72"	240"	<b>03R72X240</b>	55,672	59,352	2,560	2,560	5,962	1,527	1,976	2,176

### Base and Base Trim Upcharges

# of bases	T1__ Base	T2__ Base	HG__ Base	OT (for MC Base Metal)	PM01/PM02 Base Metal	PM03 Base Metal
2 base	\$1,116	\$2,674	\$4,581	\$3,975	\$5,347	\$6,682
3 base	1,675	4,011	7,739	5,960	8,021	10,025

Order Code	Specification Information	Refer To Accessories Section	Pricing Tiers
Example: <b>03R72X96-T003-PM01-MC01-SL01-SL01-UC0</b>	<b>To order please specify pattern number including:</b>	Please refer to Accessories section, <a href="#">page 213</a> for power details.	Please refer to Materials and Finish <a href="#">page 9</a> for specification details.
<b>03</b> Highline 50 Collection	1. Top finish	<b>Grommet options available in these finishes:</b>	T1 and T2 pricing includes powder coated base finish.
<b>R</b> Rectangular	2. Base Option	Powder coated	There is an upcharge for plated base finishes as highlighted above.
<b>72</b> Depth	3. Edge Opt./Finish (only applies if trim type is metal or leather)	Premium (Polished Chrome, Satin Nickel or Oil Rubbed Bronze)	For additional stone options and pricing please contact your sales representative."
<b>96</b> Width	4. Lower Layer Finish	<b>Power Box Options</b>	
<b>T003</b> Top Finish	5. Base Finish	<b>Code: Description:</b>	
<b>PM01</b> Base Option	6. Power box option	NP No Power	
<b>MC01</b> Edge Option/Finish	7. Table-top power finish (only applies if table-top power is selected)	UC0 Undermount	
<b>SL01</b> Lower Layer Finish	Trim Type	T1E Tabletop 1-Sided Lid	
<b>SL01</b> Base Finish	N = No trim	T2C Tabletop 2-Sided Lid	
<b>UC0</b> Undermount	M = Metal (available in Premium and Powder Coat finishes)	<b>Must select Wire Management Column and Finish:</b>	
	L = Leather	Powder coated	
		Premium (Polished Chrome, Satin Nickel or Oil Rubbed Bronze)	

# Rectangular Conference Tables

## 72" Deep Tops Glass Top

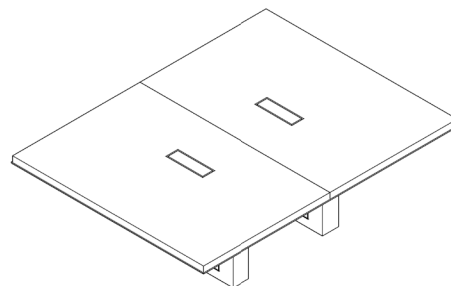

Base price includes "ON" - open leg, no metal trim, SL finish on leg and trim. "OT" - open leg, w/ metal trim is an upcharge listed below.

D	W	Pattern No.	GC__ Top	GE__ Top	PM01/ PM02 Edge Upcharge	PM03 Edge Upcharge	AU__ Edge Upcharge	SL__ Lower Layer	T__ Lower Layer	HG__ Lower Layer
72"	96"	<b>03R72X96</b>	\$32,710	\$34,044	\$1,634	\$1,634	\$3,210	\$607	\$862	\$950
72"	108"	<b>03R72X108</b>	35,141	36,642	1,634	1,634	3,439	690	1,020	1,124
72"	120"	<b>03R72X120</b>	37,716	39,383	1,634	1,634	3,669	758	1,116	1,228
72"	132"	<b>03R72X132</b>	45,335	47,169	1,731	1,731	3,764	831	1,152	1,269
72"	144"	<b>03R72X144</b>	48,160	50,159	1,731	1,731	4,128	847	1,173	1,290
72"	156"	<b>03R72X156</b>	50,554	52,722	1,731	1,731	4,356	986	1,344	1,478
72"	168"	<b>03R72X168</b>	53,484	55,816	2,560	2,560	4,587	1,043	1,448	1,594
72"	180"	<b>03R72X180</b>	55,927	58,428	2,560	2,560	4,816	1,072	1,537	1,690
72"	192"	<b>03R72X192</b>	62,878	65,544	2,560	2,560	5,044	1,152	1,623	1,785
72"	204"	<b>03R72X204</b>	65,385	68,219	2,560	2,560	5,274	1,255	1,711	1,883
72"	216"	<b>03R72X216</b>	67,788	70,914	2,560	2,560	5,503	1,316	1,801	1,979
72"	228"	<b>03R72X228</b>	70,224	73,391	2,560	2,560	5,732	1,373	1,881	2,070
72"	240"	<b>03R72X240</b>	74,529	77,864	2,560	2,560	5,962	1,527	1,976	2,176

### Base and Base Trim Upcharges

# of bases	T1__ Base	T2__ Base	HG__ Base	OT (for MC Base Metal)	PM01/PM02 Base Metal	PM03 Base Metal
2 base	\$1,116	\$2,674	\$4,581	\$3,975	\$5,347	\$6,682
3 base	1,675	4,011	7,739	5,960	8,021	10,025

Order Code	Specification Information	Refer To Accessories Section	Pricing Tiers
Example: <b>03R72X96-GE01-PM01-MC01-SL01-SL01-UCO</b>	<b>To order please specify pattern number including:</b>	Please refer to Accessories section, <b>page 213</b> for power details.	Please refer to Materials and Finish <b>page 9</b> for specification details.
<b>03</b> Highline 50 Collection	1. Top finish	<b>Grommet options available in these finishes:</b>	T1 and T2 pricing includes powder coated base finish.
<b>R</b> Rectangular	2. Base Option	Powder coated	There is an upcharge for plated base finishes as highlighted above.
<b>72</b> Depth	3. Edge Opt./Finish (only applies if trim type is metal or leather)	Premium (Polished Chrome, Satin Nickel or Oil Rubbed Bronze)	For additional stone options and pricing please contact your sales representative."
<b>96</b> Width	4. Lower Layer Finish	<b>Power Box Options</b>	
<b>GE01</b> Top Finish	5. Base Finish	<b>Code: Description:</b>	
<b>PM01</b> Base Option	6. Power box option	NP No Power	
<b>MC01</b> Edge Option/Finish	7. Table-top power finish (only applies if table-top power is selected)	UCO Undermount	
<b>SL01</b> Lower Layer Finish	Trim Type	T1E Tabletop 1-Sided Lid	
<b>SL01</b> Base Finish	N = No trim	T2C Tabletop 2-Sided Lid	
<b>UCO</b> Undermount	M = Metal (available in Premium and Powder Coat finishes)	<b>Must select Wire Management Column and Finish:</b>	
	L = Leather	Powder coated	
		Premium (Polished Chrome, Satin Nickel or Oil Rubbed Bronze)	

# Rectangular Conference Tables

## 72" Deep Tops Corian Top

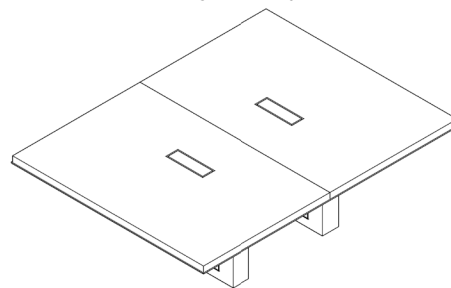

Base price includes "ON" - open leg, no metal trim, SL finish on leg and trim. "OT" - open leg, w/ metal trim is an upcharge listed below.

D	W	Pattern No.	CS01 Top	PM01/ PM02 Edge Upcharge	PM03 Edge Upcharge	AU__ Edge Upcharge	SL__ Lower Layer	T__ Lower Layer	HG__ Lower Layer
72"	96"	<b>03R72X96</b>	\$34,328	\$1,634	\$1,634	\$3,210	\$607	\$862	\$950
72"	108"	<b>03R72X108</b>	37,027	1,634	1,634	3,439	690	1,020	1,124
72"	120"	<b>03R72X120</b>	39,866	1,634	1,634	3,669	758	1,116	1,228
72"	132"	<b>03R72X132</b>	47,545	1,731	1,731	3,764	831	1,152	1,269
72"	144"	<b>03R72X144</b>	50,622	1,731	1,731	4,128	847	1,173	1,290
72"	156"	<b>03R72X156</b>	53,289	1,731	1,731	4,356	986	1,344	1,478
72"	168"	<b>03R72X168</b>	56,465	2,560	2,560	4,587	1,043	1,448	1,594
72"	180"	<b>03R72X180</b>	59,178	2,560	2,560	4,816	1,072	1,537	1,690
72"	192"	<b>03R72X192</b>	66,216	2,560	2,560	5,044	1,152	1,623	1,785
72"	204"	<b>03R72X204</b>	68,989	2,560	2,560	5,274	1,255	1,711	1,883
72"	216"	<b>03R72X216</b>	71,661	2,560	2,560	5,503	1,316	1,801	1,979
72"	228"	<b>03R72X228</b>	74,368	2,560	2,560	5,732	1,373	1,881	2,070
72"	240"	<b>03R72X240</b>	79,000	2,560	2,560	5,962	1,527	1,976	2,176

### Base and Base Trim Upcharges

# of bases	T1__ Base	T2__ Base	HG__ Base	OT (for MC Base Metal)	PM01/PM02 Base Metal	PM03 Base Metal
2 base	\$1,116	\$2,674	\$4,581	\$3,975	\$5,347	\$6,682
3 base	1,675	4,011	7,739	5,960	8,021	10,025

Order Code	Specification Information	Refer To Accessories Section	Pricing Tiers
Example: <b>03R72X96-CS01-PM01-MC01-SL01-SL01-UCO</b>	<b>To order please specify pattern number including:</b>	Please refer to Accessories section, <a href="#">page 213</a> for power details.	Please refer to Materials and Finish <a href="#">page 9</a> for specification details.
<b>03</b> Highline 50 Collection	1. Top finish	<b>Grommet options available in these finishes:</b>	T1 and T2 pricing includes powder coated base finish.
<b>R</b> Rectangular	2. Base Option	Powder coated	There is an upcharge for plated base finishes as highlighted above.
<b>72</b> Depth	3. Edge Opt./Finish (only applies if trim type is metal or leather)	Premium (Polished Chrome, Satin Nickel or Oil Rubbed Bronze)	For additional stone options and pricing please contact your sales representative."
<b>96</b> Width	4. Lower Layer Finish	<b>Power Box Options</b>	
<b>CS01</b> Top Finish	5. Base Finish	<b>Code: Description:</b>	
<b>PM01</b> Base Option	6. Power box option	NP No Power	
<b>MC01</b> Edge Option/Finish	7. Table-top power finish (only applies if table-top power is selected)	UCO Undermount	
<b>SL01</b> Lower Layer Finish	Trim Type	T1E Tabletop 1-Sided Lid	
<b>SL01</b> Base Finish	N = No trim	T2C Tabletop 2-Sided Lid	
<b>UCO</b> Undermount	M = Metal (available in Premium and Powder Coat finishes)	<b>Must select Wire Management Column and Finish:</b>	
	L = Leather	Powder coated	
		Premium (Polished Chrome, Satin Nickel or Oil Rubbed Bronze)	





# Boat Conference Tables

## 48"-72" Deep Tops

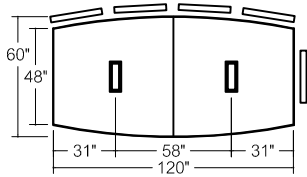
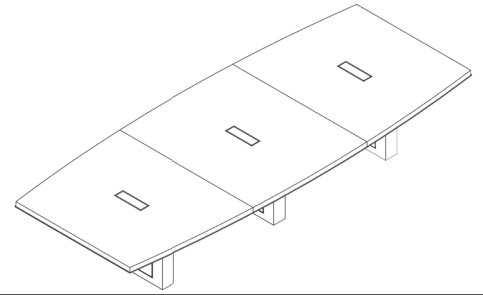

**03B60X120**

10 Person Table

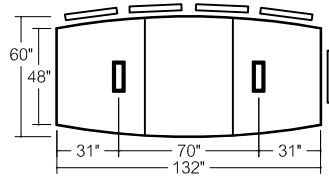

**03B60X132**

10 Person Table

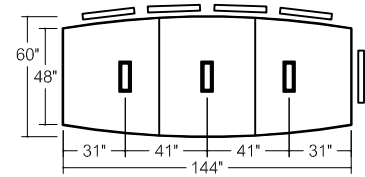

**03B60X144**

10 Person Table

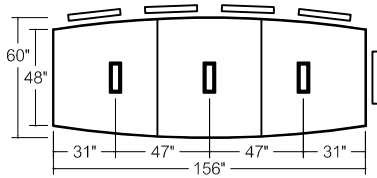

**03B60X156**

10 Person Table

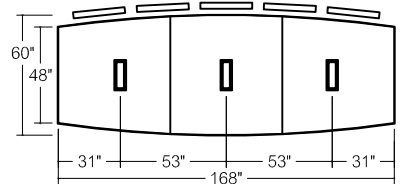

**03B60X168**

12 Person Table

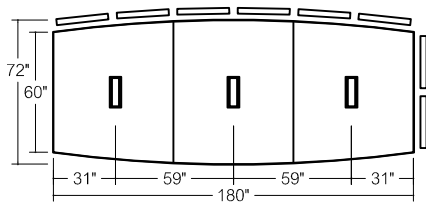

**03B72X180**

16 Person Table

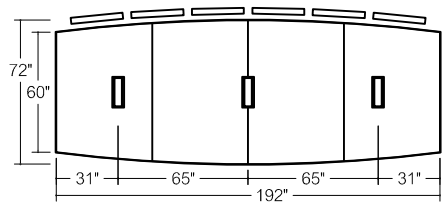

**03B72X192**

16 Person Table

# Boat Conference Tables

**48"-72" Deep Tops**

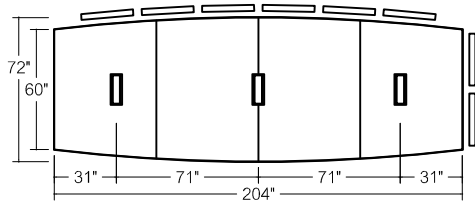
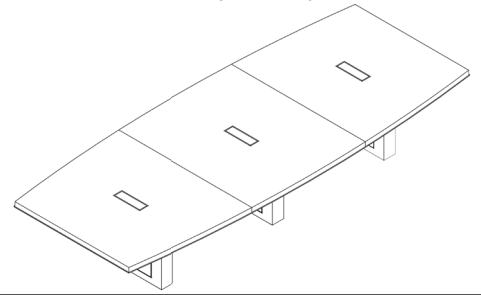

**03B72X204**

16 Person Table

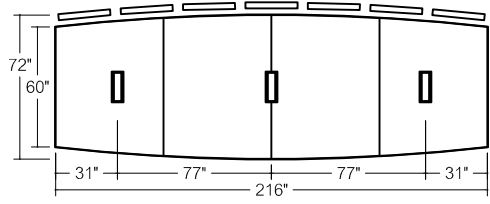

**03B72X216**

18 Person Table

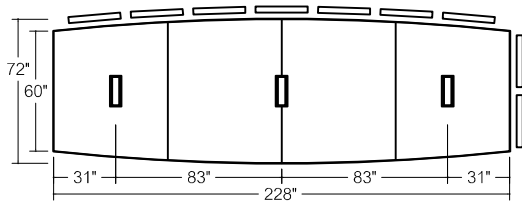

**03B72X228**

18 Person Table

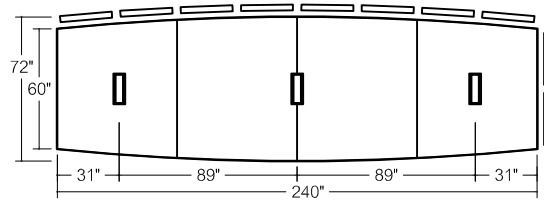

**03B72X240**

20 Person Table

# Boat Conference Tables

## 48"-72" Deep Boat Tops

### Veneer Top

Base price includes "ON" - open leg, no metal trim, SL finish on leg and trim. "OT" - open leg, w/ metal trim is an upcharge listed below.

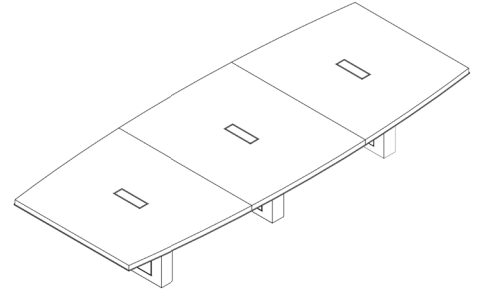

D	W	Pattern No.	T1__ Top	T2__ Top	PM01/ PM02 Edge Upcharge	PM03 Edge Upcharge	AU__ Edge Upcharge	SL__ Lower Layer	T__ Lower Layer	HG__ Lower Layer
60"	120"	<b>03B60X120</b>	\$31,825	\$33,358	\$2,413	\$6,095	\$4,074	\$741	\$1,094	\$1,204
60"	132"	<b>03B60X132</b>	38,846	40,533	3,250	8,110	4,361	831	1,110	1,222
60"	144"	<b>03B60X144</b>	40,869	42,708	3,171	8,110	4,647	888	1,191	1,309
60"	156"	<b>03B60X156</b>	42,371	44,364	3,170	8,109	4,933	991	1,320	1,451
60"	168"	<b>03B60X168</b>	43,899	46,043	3,210	8,110	5,222	1,094	1,484	1,633
72"	180"	<b>03B72X180</b>	50,607	53,367	3,223	8,110	5,794	1,234	1,720	1,891
72"	192"	<b>03B72X192</b>	57,021	59,964	3,782	9,892	6,083	1,337	1,733	1,908
72"	204"	<b>03B72X204</b>	58,806	61,933	3,782	9,892	6,370	1,463	1,938	2,134
72"	216"	<b>03B72X216</b>	60,723	64,034	3,782	9,944	6,657	1,527	1,976	2,176
72"	228"	<b>03B72X228</b>	65,297	68,792	3,835	9,944	6,942	1,537	2,086	2,294
72"	240"	<b>03B72X240</b>	66,990	70,669	3,835	9,944	7,232	1,668	2,176	2,392

#### Base and Base Trim Upcharges - small bases

# of bases	T1__ Base	T2__ Base	HG__ Base	OT (for MC Base Metal)	PM01/PM02 Base Metal	PM03 Base Metal
2 base	\$1,001	\$2,098	\$4,581	\$3,975	\$5,347	\$6,682
3 base	1,502	3,147	6,872	5,960	8,021	10,025

#### Base and Base Trim Upcharges - large bases

# of bases	T1__ Base	T2__ Base	HG__ Base	OT (for MC Base Metal)	PM01/PM02 Base Metal	PM03 Base Metal
2 base	\$1,116	\$2,674	\$4,581	\$3,975	\$5,347	\$6,682
3 base	1,675	4,011	7,739	5,960	8,021	10,025

Order Code	Specification Information	Refer To Accessories Section	Pricing Tiers
Example: <b>03B60X120-T003-PM01-MC01-SL01-SL01-UCO</b>	<b>To order please specify pattern number including:</b>	Please refer to Accessories section, <b>page 213</b> for power details.	Please refer to Materials and Finish <b>page 9</b> for specification details.
<b>03</b> Highline 50 Collection	1. Top finish	<b>Grommet options available in these finishes:</b>	T1 and T2 pricing includes powder coated base finish.
<b>B</b> Boat	2. Base Option	Powder coated	There is an upcharge for plated base finishes as highlighted above.
<b>60</b> Depth	3. Edge Opt./Finish (only applies if trim type is metal or leather)	Premium (Polished Chrome, Satin Nickel or Oil Rubbed Bronze)	For additional stone options and pricing please contact your sales representative."
<b>120</b> Width	4. Lower Layer Finish	<b>Power Box Options</b>	
<b>T003</b> Top Finish	5. Base Finish	<b>Code: Description:</b>	
<b>PM01</b> Base Option	6. Power box option	NP No Power	
<b>MC01</b> Edge Option/Finish	7. Table-top power finish (only applies if table-top power is selected)	UCO Undermount	
<b>SL01</b> Lower Layer Finish	Trim Type	T1E Tabletop 1-Sided Lid	
<b>SL01</b> Base Finish	N = No trim	T2C Tabletop 2-Sided Lid	
<b>UCO</b> Undermount	M = Metal (available in Premium and Powder Coat finishes)	<b>Must select Wire Management Column and Finish:</b>	
	L = Leather	Powder coated	
		Premium (Polished Chrome, Satin Nickel or Oil Rubbed Bronze)	

# Boat Conference Tables

## 48"-72" Deep Boat Tops

### Glass Top

Base price includes "ON" - open leg, no metal trim, SL finish on leg and trim. "OT" - open leg, w/ metal trim is an upcharge listed below.

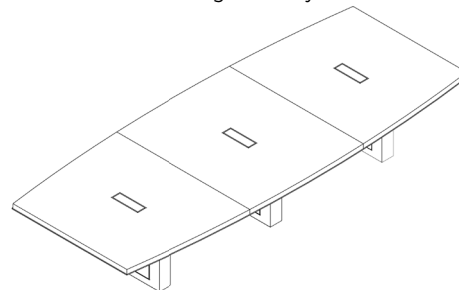

D	W	Pattern No.	GC__ Top	GE__ Top	PM01/ PM02 Edge Upcharge	PM03 Edge Upcharge	AU__ Edge Upcharge	SL__ Lower Layer	T__ Lower Layer	HG__ Lower Layer
60"	120"	<b>03B60X120</b>	\$43,590	\$45,674	\$2,413	\$6,095	\$4,074	\$741	\$1,094	\$1,204
60"	132"	<b>03B60X132</b>	51,951	54,242	3,250	8,110	4,361	831	1,110	1,222
60"	144"	<b>03B60X144</b>	55,100	57,601	3,171	8,110	4,647	888	1,191	1,309
60"	156"	<b>03B60X156</b>	57,708	60,416	3,170	8,109	4,933	991	1,320	1,451
60"	168"	<b>03B60X168</b>	60,341	63,258	3,210	8,110	5,222	1,094	1,484	1,633
72"	180"	<b>03B72X180</b>	71,502	75,254	3,223	8,110	5,794	1,234	1,720	1,891
72"	192"	<b>03B72X192</b>	79,437	83,438	3,782	9,892	6,083	1,337	1,733	1,908
72"	204"	<b>03B72X204</b>	82,548	86,799	3,782	9,892	6,370	1,463	1,938	2,134
72"	216"	<b>03B72X216</b>	85,796	90,297	3,782	9,944	6,657	1,527	1,976	2,176
72"	228"	<b>03B72X228</b>	91,813	82,672	3,835	9,944	6,942	1,537	2,086	2,294
72"	240"	<b>03B72X240</b>	94,829	99,830	3,835	9,944	7,232	1,668	2,176	2,392

#### Base and Base Trim Upcharges - small bases

# of bases	T1__ Base	T2__ Base	HG__ Base	OT (for MC Base Metal)	PM01/PM02 Base Metal	PM03 Base Metal
2 base	\$1,001	\$2,098	\$4,581	\$3,975	\$5,347	\$6,682
3 base	1,502	3,147	6,872	5,960	8,021	10,025

#### Base and Base Trim Upcharges - large bases

# of bases	T1__ Base	T2__ Base	HG__ Base	OT (for MC Base Metal)	PM01/PM02 Base Metal	PM03 Base Metal
2 base	\$1,116	\$2,674	\$4,581	\$3,975	\$5,347	\$6,682
3 base	1,675	4,011	7,739	5,960	8,021	10,025

Order Code	Specification Information	Refer To Accessories Section	Pricing Tiers
Example: <b>03B60X120-GE01-PM01-MC01-SL01-SL01-UCO</b>	<b>To order please specify pattern number including:</b>	Please refer to Accessories section, <b>page 213</b> for power details.	Please refer to Materials and Finish <b>page 9</b> for specification details.
<b>03</b> Highline 50 Collection	1. Top finish	<b>Grommet options available in these finishes:</b>	T1 and T2 pricing includes powder coated base finish.
<b>B</b> Boat	2. Base Option	Powder coated	There is an upcharge for plated base finishes as highlighted above.
<b>60</b> Depth	3. Edge Opt./Finish (only applies if trim type is metal or leather)	Premium (Polished Chrome, Satin Nickel or Oil Rubbed Bronze)	For additional stone options and pricing please contact your sales representative."
<b>120</b> Width	4. Lower Layer Finish	<b>Power Box Options</b>	
<b>GE01</b> Top Finish	5. Base Finish	<b>Code: Description:</b>	
<b>PM01</b> Base Option	6. Power box option	NP No Power	
<b>MC01</b> Edge Option/Finish	7. Table-top power finish (only applies if table-top power is selected)	UCO Undermount	
<b>SL01</b> Lower Layer Finish	Trim Type	T1E Tabletop 1-Sided Lid	
<b>SL01</b> Base Finish	N = No trim	T2C Tabletop 2-Sided Lid	
<b>UCO</b> Undermount	M = Metal (available in Premium and Powder Coat finishes)	<b>Must select Wire Management Column and Finish:</b>	
	L = Leather	Powder coated	
		Premium (Polished Chrome, Satin Nickel or Oil Rubbed Bronze)	

# Boat Conference Tables

## 48"-72" Deep Boat Tops

### Corian Top

Base price includes "ON" - open leg, no metal trim, SL finish on leg and trim. "OT" - open leg, w/ metal trim is an upcharge listed below.

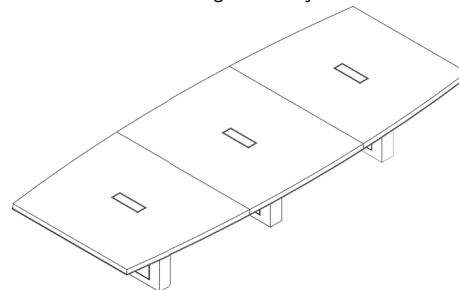

D	W	Pattern No.	CS01 Top	PM01/ PM02 Edge Upcharge	PM03 Edge Upcharge	AU__ Edge Upcharge	SL__ Lower Layer	T__ Lower Layer	HG__ Lower Layer
60"	120"	<b>03B60X120</b>	\$47,821	\$2,413	\$6,095	\$4,074	\$741	\$1,094	\$1,204
60"	132"	<b>03B60X132</b>	56,442	3,250	8,110	4,361	831	1,110	1,222
60"	144"	<b>03B60X144</b>	60,065	3,171	8,110	4,647	888	1,191	1,309
60"	156"	<b>03B60X156</b>	63,166	3,170	8,109	4,933	991	1,320	1,451
60"	168"	<b>03B60X168</b>	66,293	3,210	8,110	5,222	1,094	1,484	1,633
72"	180"	<b>03B72X180</b>	79,401	3,223	8,110	5,794	1,234	1,720	1,891
72"	192"	<b>03B72X192</b>	87,734	3,782	9,892	6,083	1,337	1,733	1,908
72"	204"	<b>03B72X204</b>	91,439	3,782	9,892	6,370	1,463	1,938	2,134
72"	216"	<b>03B72X216</b>	95,275	3,782	9,944	6,657	1,527	1,976	2,176
72"	228"	<b>03B72X228</b>	101,769	3,835	9,944	6,942	1,537	2,086	2,294
72"	240"	<b>03B72X240</b>	105,381	3,835	9,944	7,232	1,668	2,176	2,392

#### Base and Base Trim Upcharges - small bases

# of bases	T1__ Base	T2__ Base	HG__ Base	OT (for MC Base Metal)	PM01/PM02 Base Metal	PM03 Base Metal
2 base	\$1,001	\$2,098	\$4,581	\$3,975	\$5,347	\$6,682
3 base	1,502	3,147	6,872	5,960	8,021	10,025

#### Base and Base Trim Upcharges - large bases

# of bases	T1__ Base	T2__ Base	HG__ Base	OT (for MC Base Metal)	PM01/PM02 Base Metal	PM03 Base Metal
2 base	\$1,116	\$2,674	\$4,581	\$3,975	\$5,347	\$6,682
3 base	1,675	4,011	7,739	5,960	8,021	10,025

Order Code	Specification Information	Refer To Accessories Section	Pricing Tiers
Example: <b>03B60X120-CS01-PM01-MC01-SL01-SL01-UC0</b>	<b>To order please specify pattern number including:</b>	Please refer to Accessories section, <a href="#">page 213</a> for power details.	Please refer to Materials and Finish <a href="#">page 9</a> for specification details.
<b>03</b> Highline 50 Collection	1. Top finish	<b>Grommet options available in these finishes:</b>	T1 and T2 pricing includes powder coated base finish.
<b>B</b> Boat	2. Base Option	Powder coated	There is an upcharge for plated base finishes as highlighted above.
<b>60</b> Depth	3. Edge Opt./Finish (only applies if trim type is metal or leather)	Premium (Polished Chrome, Satin Nickel or Oil Rubbed Bronze)	For additional stone options and pricing please contact your sales representative."
<b>120</b> Width	4. Lower Layer Finish	<b>Power Box Options</b>	
<b>CS01</b> Top Finish	5. Base Finish	<b>Code: Description:</b>	
<b>PM01</b> Base Option	6. Power box option	NP No Power	
<b>MC01</b> Edge Option/Finish	7. Table-top power finish (only applies if table-top power is selected)	UC0 Undermount	
<b>SL01</b> Lower Layer Finish	Trim Type	T1E Tabletop 1-Sided Lid	
<b>SL01</b> Base Finish	N = No trim	T2C Tabletop 2-Sided Lid	
<b>UC0</b> Undermount	M = Metal (available in Premium and Powder Coat finishes)	<b>Must select Wire Management Column and Finish:</b>	
	L = Leather	Powder coated	
		Premium (Polished Chrome, Satin Nickel or Oil Rubbed Bronze)	







# Highline Collection

## Highline Fifty Meeting Tables



**DATESWEISER**

# General Specifications

## Highline Fifty Meeting Tables

### Overall Elevations and Clearance

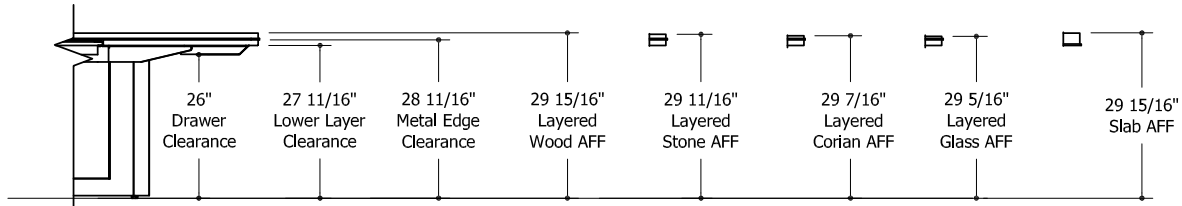

### Round Table Layouts

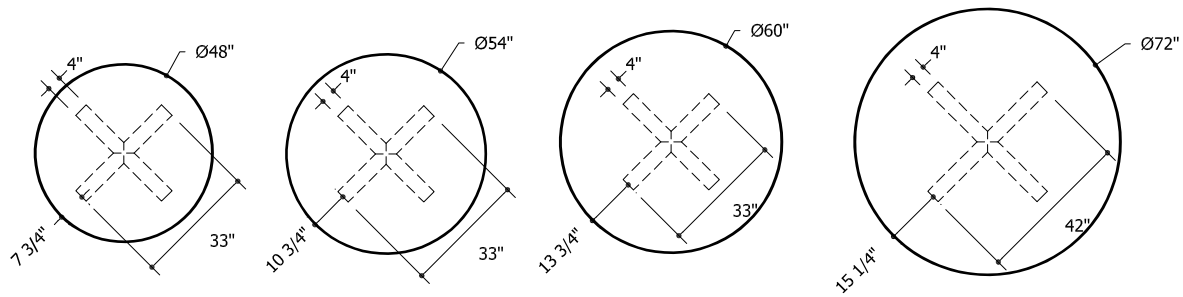

### Square Table Layouts

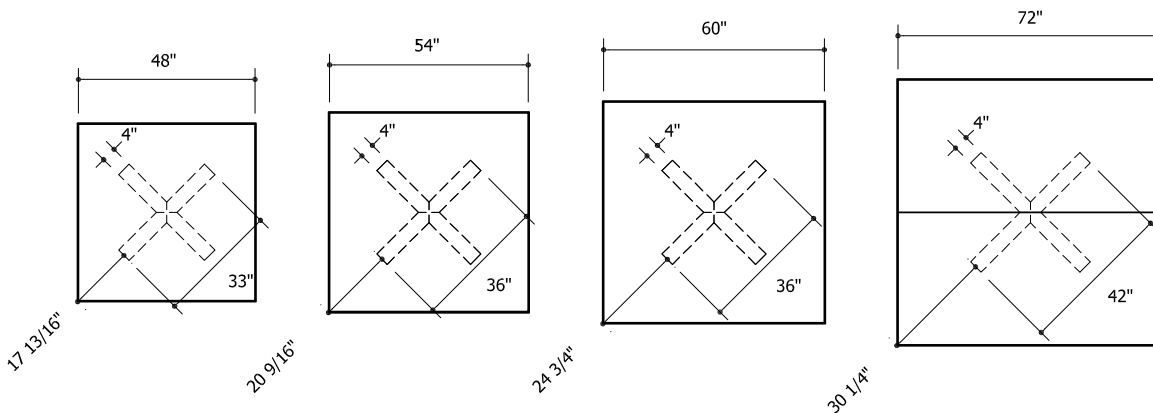

# General Specifications

## Highline Fifty Meeting Tables

### Top Construction

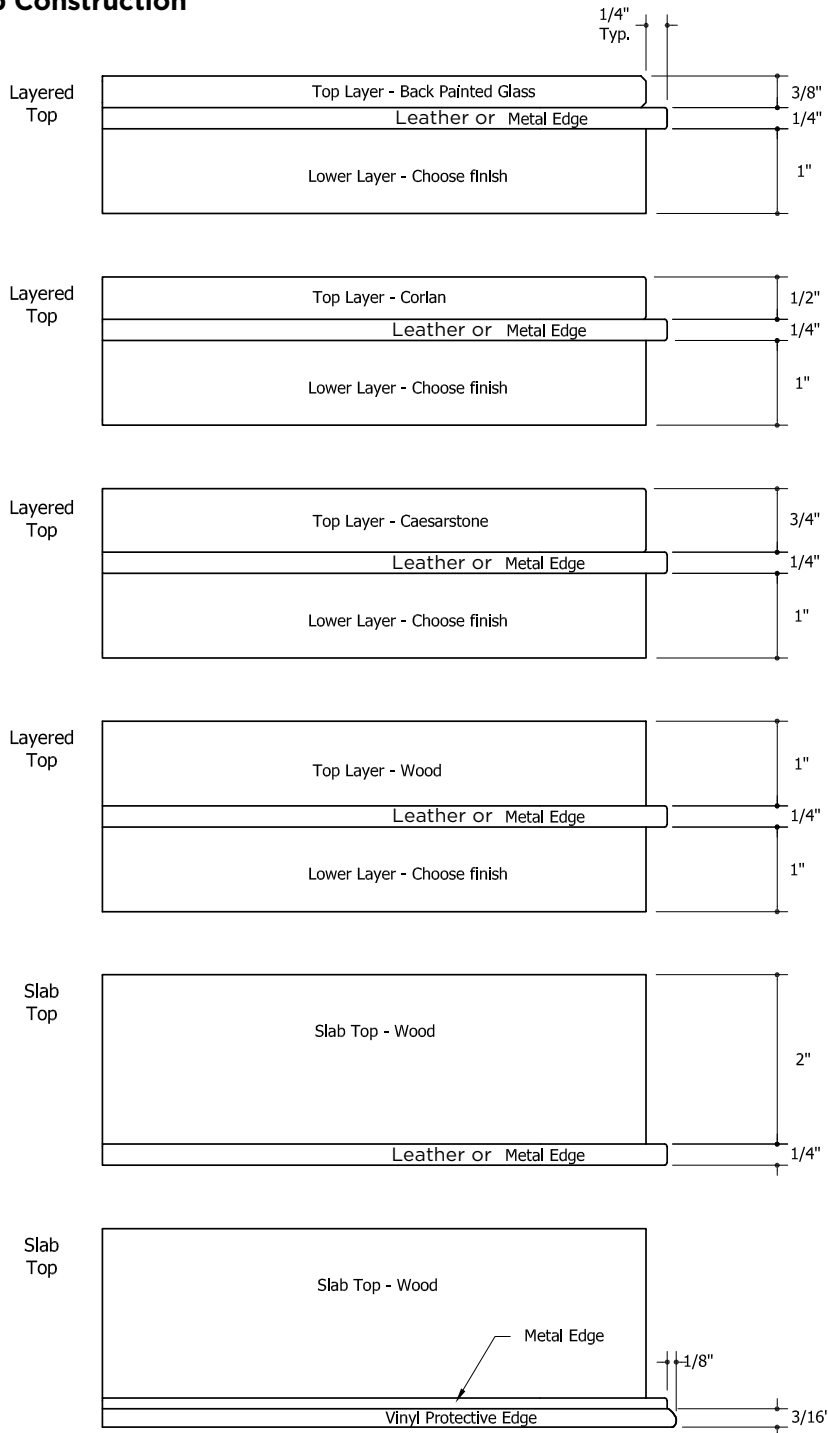

# General Specifications

## Highline Fifty Meeting Tables

### Base Construction

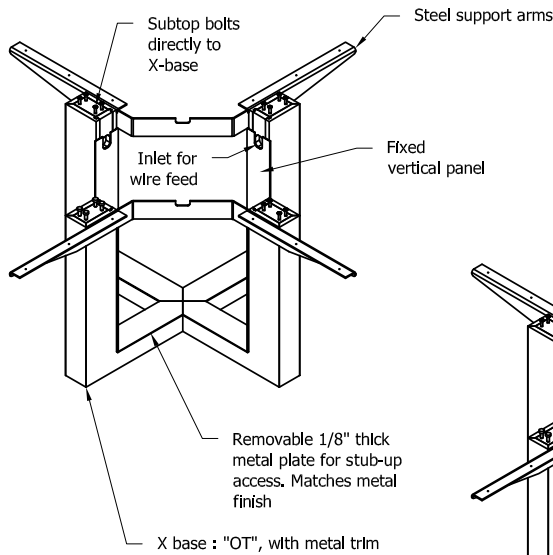

- HL03 X base :
- 33" fits - 48" Round
  - 48" Square
  - 54" Round
  
  - 36" fits - 54" Square
  - 60" Round
  - 60" Square
  
  - 42" fits - 72" Round
  - 72" Square

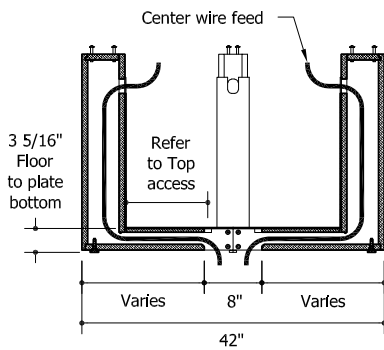
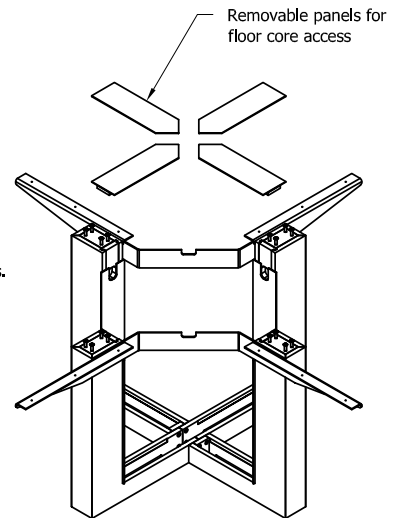
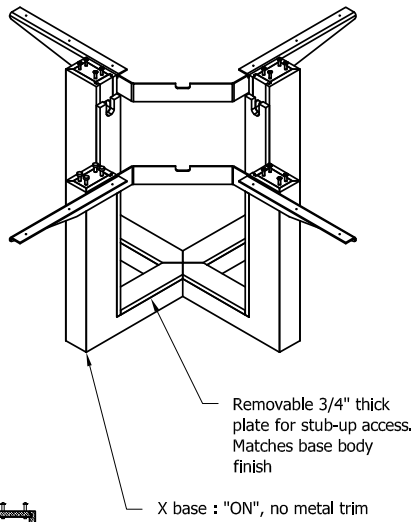

Vertical section at center of Base

- Top access:
- 33" - 2 3/8" x 6 7/8"
  - 36" - 2 3/8" x 8 3/8"
  - 42" - 2 3/8" x 11 3/8"

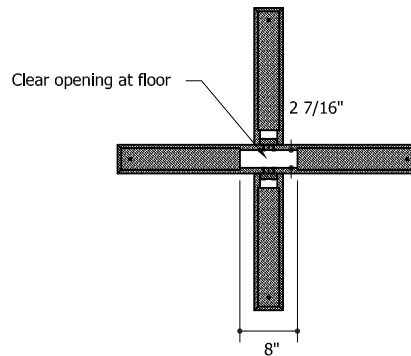

Horizontal section of typical base

# General Specifications

## Highline Fifty Meeting Tables

### Power Drawer & Connectivity Layout

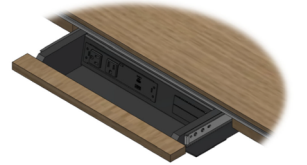
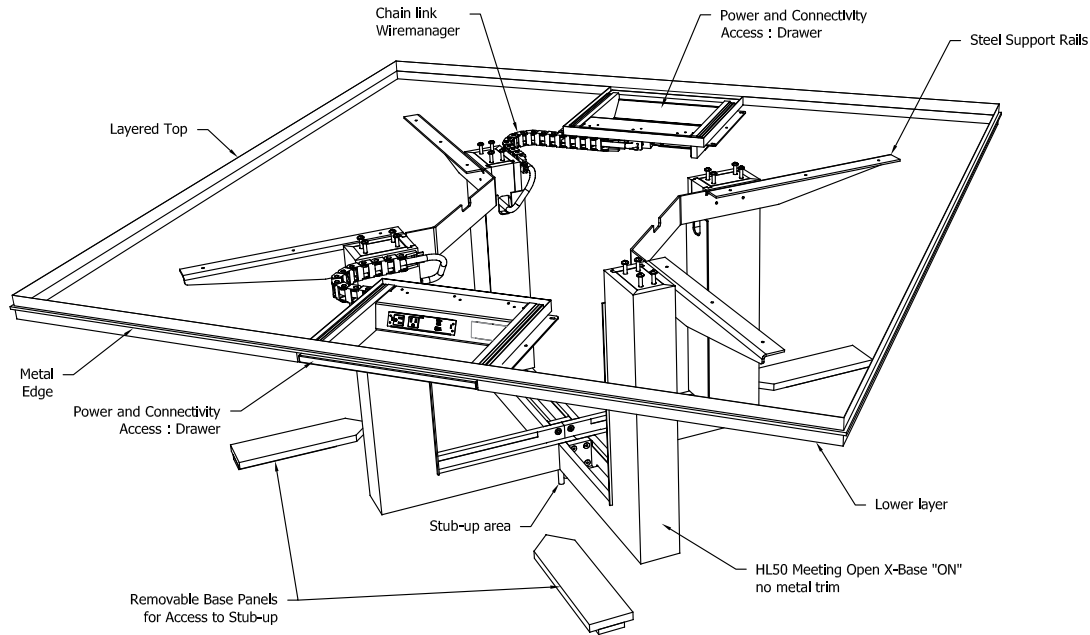

Small Power Drawer

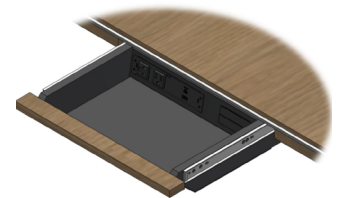

Large Power Drawer

### Undermount Power & Connectivity Layout

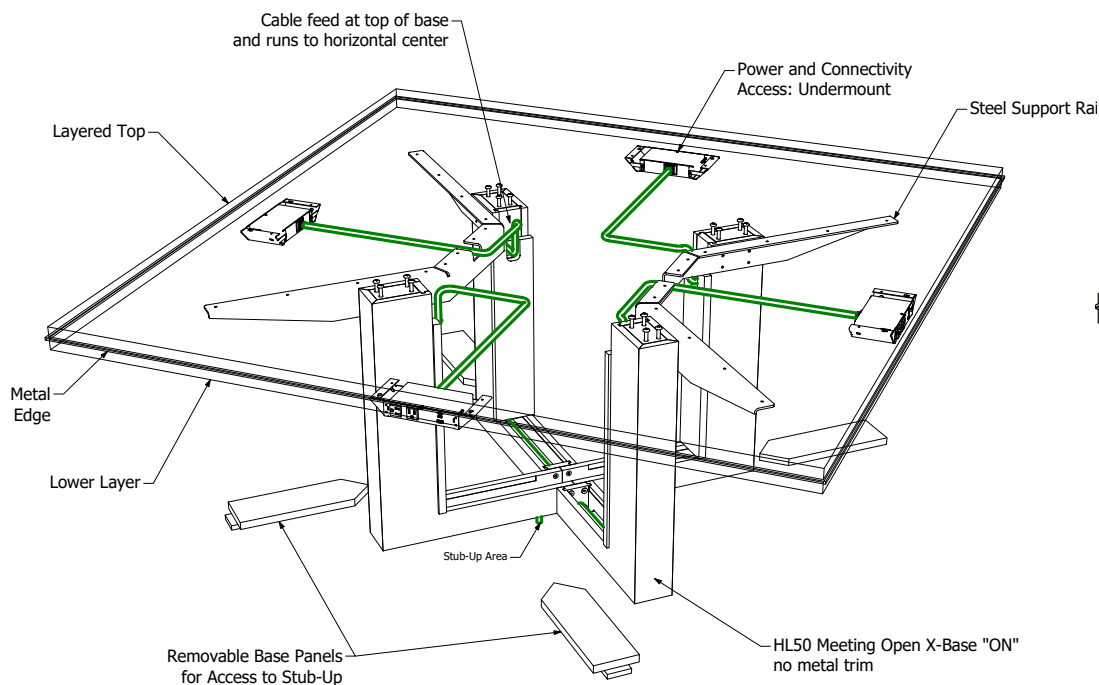

Undermount Power

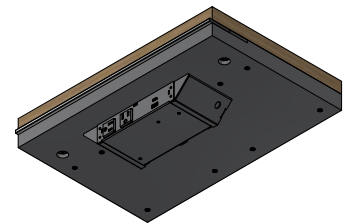

# General Specifications

## Highline Fifty Meeting Tables

### Table Top Power & Connectivity Layout

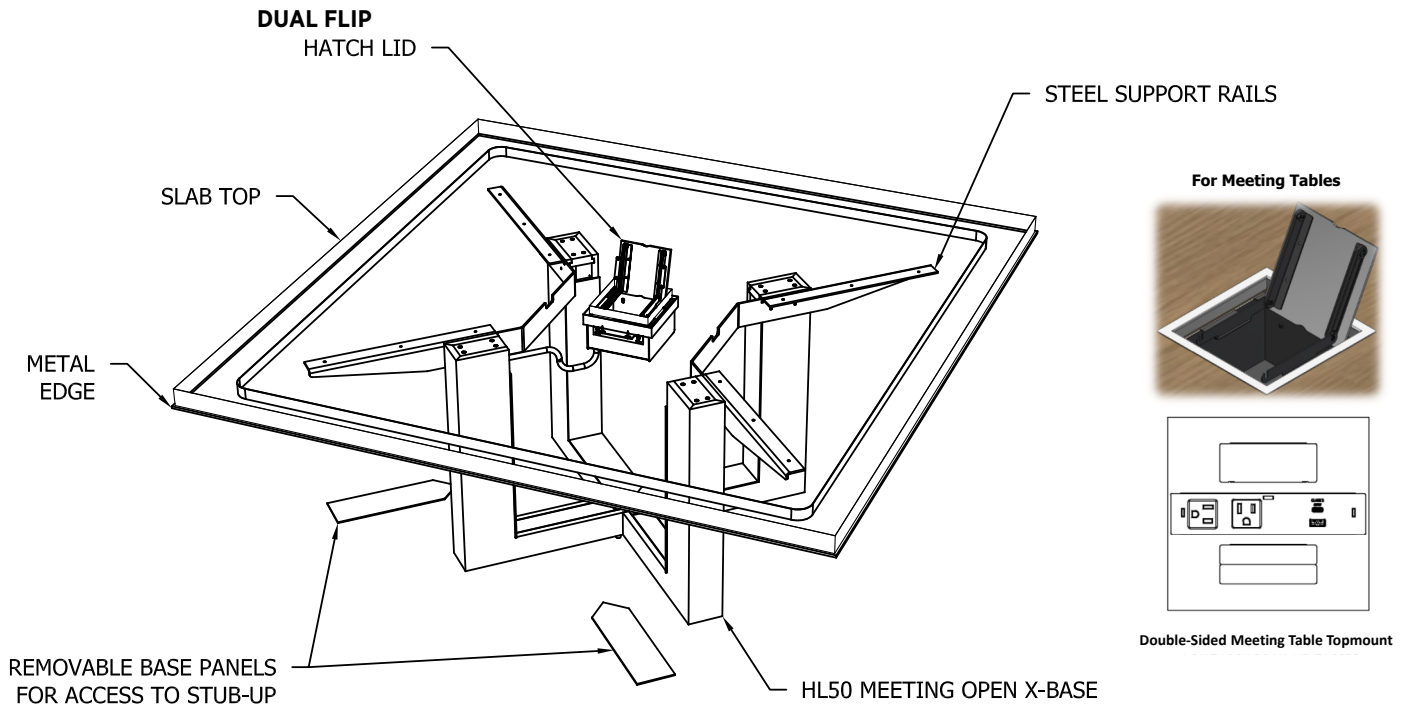



# Highline Fifty Meeting Tables

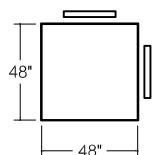
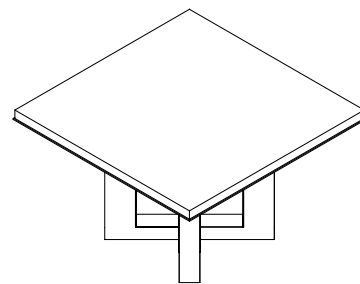

**03M48S**  
4 Person Table

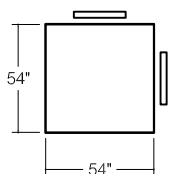

**03M54S**  
4 Person Table

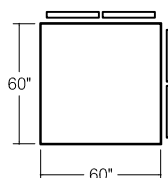

**03M60S**  
8 Person Table

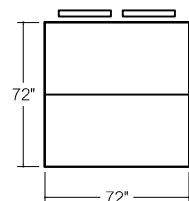

**03M72S**  
8 Person Table

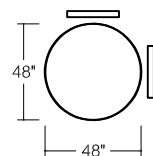

**03M48C**  
4 Person Table

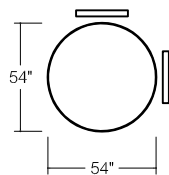

**03M54C**  
4 Person Table

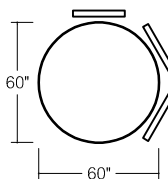

**03M60C**  
6 Person Table

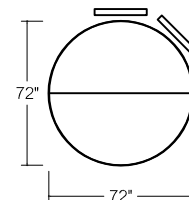

**03M72C**  
8 Person Table



# Highline Fifty Meeting Tables

## Square & Round Meeting Tables Veneer Top

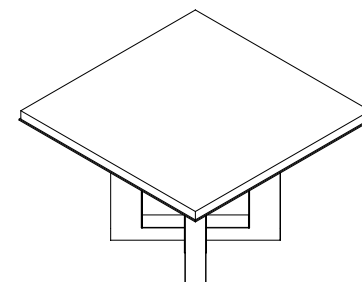

Base price includes "ON" - open leg, no metal trim, SL finish on leg and trim. "OT" - open leg, w/ metal trim is an upcharge listed below.

Dimension	Pattern No.	T1__ Top	T2__ Top	PM01/ PM02 Edge Upcharge	PM03 Edge Upcharge	AU__ Edge Upcharge	SL__ Lower Layer	T__ Lower Layer	HG__ Lower Layer
48"x48"	<b>03M48S</b>	\$24,284	\$26,726	\$390	\$779	\$1,834	\$218	\$536	\$536
54"x54"	<b>03M54S</b>	26,227	28,865	390	779	2,062	235	578	578
60"x60"	<b>03M60S</b>	28,322	31,174	390	779	2,292	255	625	625
72"x72"	<b>03M72S</b>	30,591	33,667	390	779	2,751	275	675	675
48"D	<b>03M48C</b>	26,517	28,134	790	1,576	1,809	297	728	728
54"D	<b>03M54C</b>	28,639	31,229	790	1,671	2,035	321	787	787
60"D	<b>03M60C</b>	30,930	34,664	790	1,771	2,262	346	850	850
72"D	<b>03M72C</b>	33,405	38,477	790	1,877	2,715	374	918	918

### Base and Base Trim Upcharges

Size	T1__ Base	T2__ Base	HG__ Base	OT (for MC Base Metal)	PM01/PM02 Base Metal	PM03 Base Metal
<b>48", 54", 60"D</b>	\$2,212	\$2,740	\$7,140	\$2,294	\$2,569	\$3,185
<b>72"D</b>	2,455	3,042	7,925	2,278	2,852	3,537

Order Code	Specification Information	Refer To Accessories Section	Pricing Tiers
Example: <b>04M48S-T003-PM01-MC01-SL01-SL01-UCO</b>	<b>To order please specify pattern number including:</b>	Please refer to Accessories section, <a href="#">page 213</a> for power details.	Please refer to Materials and Finish <a href="#">page 9</a> for specification details.
<b>04</b> Highline 50 Collection	1. Top finish	<b>Grommet options available in these finishes:</b>	T1 and T2 pricing includes powder coated base finish.
<b>M</b> Meeting	2. Base Option	Powder coated	There is an upcharge for plated base finishes as highlighted above.
<b>48</b> Depth	3. Edge Opt./Finish (only applies if trim type is metal or leather)	Premium (Polished Chrome, Satin Nickel or Oil Rubbed Bronze)	For additional stone options and pricing please contact your sales representative."
<b>S</b> Square	4. Lower Layer Finish	<b>Power Box Options</b>	
<b>T003</b> Top Finish	5. Base Finish	<b>Code: Description:</b>	
<b>PM01</b> Base Option	6. Power box option	NP No Power	
<b>MC01</b> Edge Option/Finish	7. Table-top power finish (only applies if table-top power is selected)	UCO Undermount	
<b>SL01</b> Lower Layer Finish	Trim Type	T1E Tabletop 1-Sided Lid	
<b>SL01</b> Base Finish	N = No trim	T2C Tabletop 2-Sided Lid	
<b>UCO</b> Undermount	M = Metal (available in Premium and Powder Coat finishes)	<b>Must select Wire Management Column and Finish:</b>	
	L = Leather	Powder coated	
		Premium (Polished Chrome, Satin Nickel or Oil Rubbed Bronze)	

# Highline Fifty Meeting Tables

## Square & Round Meeting Tables

### Glass Top

Base price includes "ON" - open leg, no metal trim, SL finish on leg and trim. "OT" - open leg, w/ metal trim is an upcharge listed below.

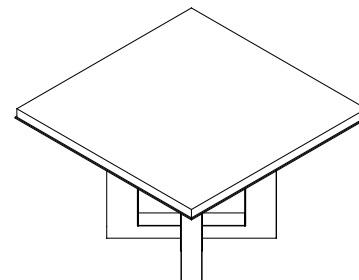

Dimension	Pattern No.	GC__ Top	GE__ Top	PM01/ PM02 Edge Upcharge	PM03 Edge Upcharge	AU__ Edge Upcharge	SL__ Lower Layer	T__ Lower Layer	HG__ Lower Layer
48"x48"	<b>03M48S</b>	\$28,461	\$29,172	\$390	\$779	\$1,834	\$218	\$536	\$536
54"x54"	<b>03M54S</b>	30,738	31,506	390	779	2,062	235	578	578
60"x60"	<b>03M60S</b>	33,197	34,027	390	779	2,292	255	625	625
72"x72"	<b>03M72S</b>	35,852	36,749	390	779	2,751	275	675	675
48"D	<b>03M48C</b>	31,079	31,855	790	1,576	1,809	297	728	728
54"D	<b>03M54C</b>	33,565	2,454	790	1,671	2,035	321	787	787
60"D	<b>03M60C</b>	36,249	37,156	790	1,771	2,262	346	850	850
72"D	<b>03M72C</b>	39,149	40,128	790	1,877	2,715	374	918	918

### Base and Base Trim Upcharges

Size	T1__ Base	T2__ Base	HG__ Base	OT (for MC Base Metal)	PM01/PM02 Base Metal	PM03 Base Metal
<b>48", 54", 60"D</b>	\$2,212	\$2,740	\$7,140	\$2,294	\$2,569	\$3,185
<b>72"D</b>	2,455	3,042	7,925	2,278	2,852	3,537

Order Code	Specification Information	Refer To Accessories Section	Pricing Tiers
Example: <b>04M48S-GE01-PM01-MC01-SL01-SL01-UCO</b>	<b>To order please specify pattern number including:</b>	Please refer to Accessories section, <a href="#">page 213</a> for power details. <b>Grommet options available in these finishes:</b> Powder coated Premium (Polished Chrome, Satin Nickel or Oil Rubbed Bronze) <b>Power Box Options</b> <b>Code: Description:</b> NP No Power UCO Undermount T1E Tabletop 1-Sided Lid T2C Tabletop 2-Sided Lid <b>Must select Wire Management Column and Finish:</b> Powder coated Premium (Polished Chrome, Satin Nickel or Oil Rubbed Bronze)	Please refer to Materials and Finish <a href="#">page 9</a> for specification details. T1 and T2 pricing includes powder coated base finish. There is an upcharge for plated base finishes as highlighted above. For additional stone options and pricing please contact your sales representative."
<b>04</b> Highline 50 Collection	1. Top finish		
<b>M</b> Meeting	2. Base Option		
<b>48</b> Depth	3. Edge Opt./Finish (only applies if trim type is metal or leather)		
<b>S</b> Square	4. Lower Layer Finish		
<b>GE01</b> Top Finish	5. Base Finish		
<b>PM01</b> Base Option	6. Power box option		
<b>MC01</b> Edge Option/Finish	7. Table-top power finish (only applies if table-top power is selected)		
<b>SL01</b> Lower Layer Finish	<b>Trim Type</b> N = No trim		
<b>SL01</b> Base Finish	M = Metal (available in Premium and Powder Coat finishes)		
<b>UCO</b> Undermount	L = Leather		

# Highline Fifty Meeting Tables

## Square & Round Meeting Tables Corian Top

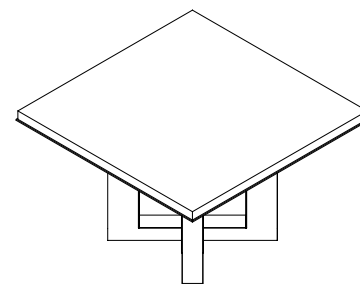

Base price includes "ON" - open leg, no metal trim, SL finish on leg and trim. "OT" - open leg, w/ metal trim is an upcharge listed below.

Dimension	Pattern No.	CS01 Top	PM01/ PM02 Edge Upcharge	PM03 Edge Upcharge	AU__ Edge Upcharge	SL__ Lower Layer	T__ Lower Layer	HG__ Lower Layer
48"x48"	<b>03M48S</b>	\$28,589	\$390	\$779	\$1,834	\$218	\$536	\$536
54"x54"	<b>03M54S</b>	30,876	390	779	2,062	235	578	578
60"x60"	<b>03M60S</b>	33,346	390	779	2,292	255	625	625
72"x72"	<b>03M72S</b>	36,014	390	779	2,751	275	675	675
48"D	<b>03M48C</b>	31,218	790	1,576	1,809	297	728	728
54"D	<b>03M54C</b>	33,716	790	1,671	2,035	321	787	787
60"D	<b>03M60C</b>	36,413	790	1,771	2,262	346	850	850
72"D	<b>03M72C</b>	39,326	790	1,877	2,715	374	918	918

### Base and Base Trim Upcharges

Size	T1__ Base	T2__ Base	HG__ Base	OT (for MC Base Metal)	PM01/PM02 Base Metal	PM03 Base Metal
<b>48", 54", 60"D</b>	\$2,212	\$2,740	\$7,140	\$2,294	\$2,569	\$3,185
<b>72"D</b>	2,455	3,042	7,925	2,278	2,852	3,537

Order Code	Specification Information	Refer To Accessories Section	Pricing Tiers
Example: <b>04M48S-CS01-PM01-MC01-SL01-SL01-UCO</b>	<b>To order please specify pattern number including:</b>	Please refer to Accessories section, <a href="#">page 213</a> for power details.	Please refer to Materials and Finish <a href="#">page 9</a> for specification details.
<b>04</b> Highline 50 Collection	1. Top finish	<b>Grommet options available in these finishes:</b>	T1 and T2 pricing includes powder coated base finish.
<b>M</b> Meeting	2. Base Option	Powder coated	There is an upcharge for plated base finishes as highlighted above.
<b>48</b> Depth	3. Edge Opt./Finish (only applies if trim type is metal or leather)	Premium (Polished Chrome, Satin Nickel or Oil Rubbed Bronze)	For additional stone options and pricing please contact your sales representative."
<b>S</b> Square	4. Lower Layer Finish	<b>Power Box Options</b>	
<b>CS01</b> Top Finish	5. Base Finish	<b>Code: Description:</b>	
<b>PM01</b> Base Option	6. Power box option	NP No Power	
<b>MC01</b> Edge Option/Finish	7. Table-top power finish (only applies if table-top power is selected)	UCO Undermount	
<b>SL01</b> Lower Layer Finish	Trim Type	T1E Tabletop 1-Sided Lid	
<b>SL01</b> Base Finish	N = No trim	T2C Tabletop 2-Sided Lid	
<b>UCO</b> Undermount	M = Metal (available in Premium and Powder Coat finishes)	<b>Must select Wire Management Column and Finish:</b>	
	L = Leather	Powder coated	
		Premium (Polished Chrome, Satin Nickel or Oil Rubbed Bronze)	



Highline Collection  
Highline Fifty Credenzas



**DATESWEISER**

# General Specifications

## Highline Fifty Credenzas

### Credenza Elevations & Optional Tops

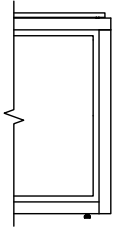

Optional Top  
3/4" Caesarstone

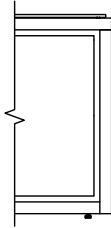

Optional Top  
1/2" Cortan

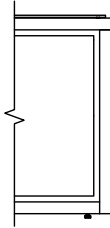

Optional Top  
3/8" Glass

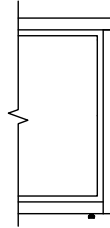

Optional Top  
None

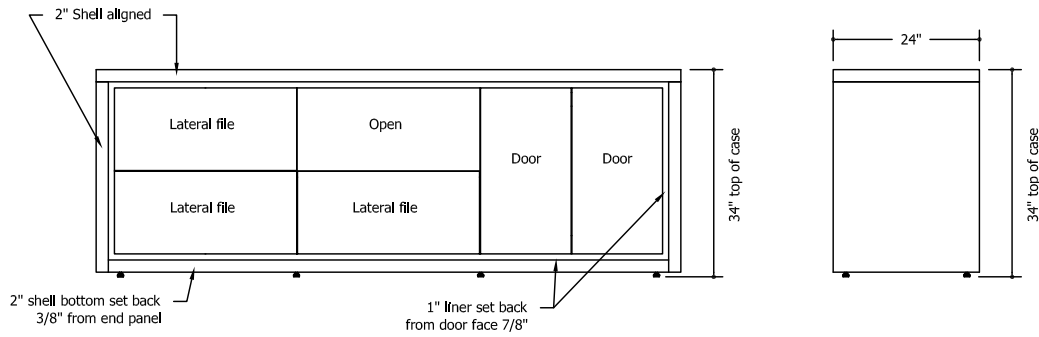
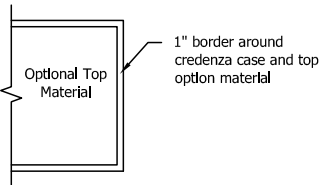

Buffet Height Credenza

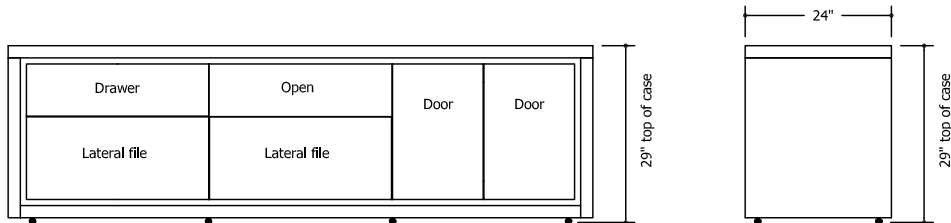

Conference Height Credenza

# General Specifications

## Highline Fifty Credenzas

### Credenza Case Details

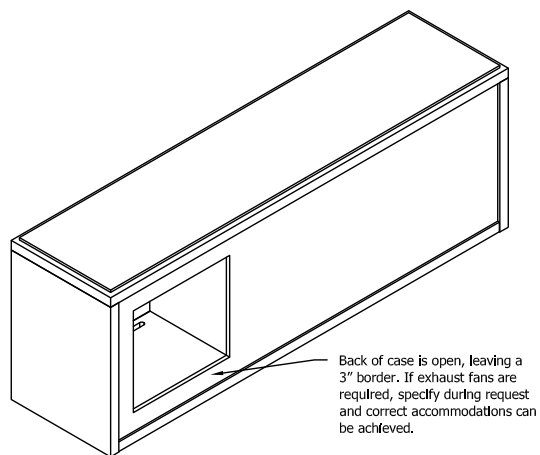

Back of Credenza

Back of case is open, leaving a 3" border. If exhaust fans are required, specify during request and correct accommodations can be achieved.

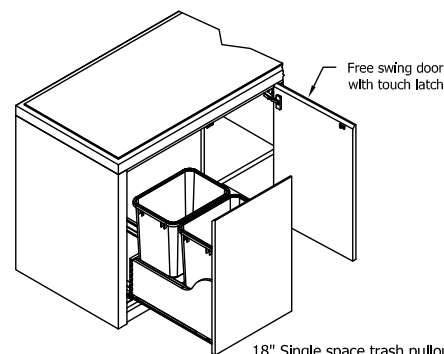

Free swing door with touch latch

18" Single space trash pullout  
 - (2) 8.75 gallon receptacles  
 - Front to back orientation  
 - Containers are black plastic

36" Double space trash pullout  
 - (4) 8.75 gallon receptacles  
 - Front to back orientation  
 - Containers are black plastic

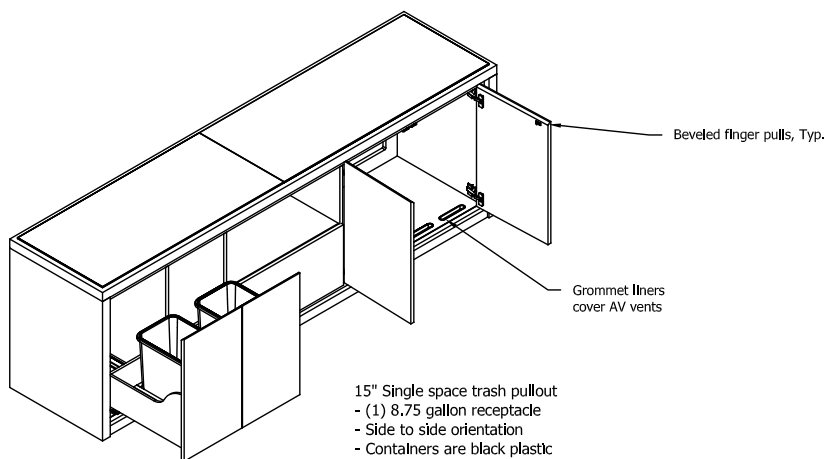

Front of Credenza

Beveled finger pulls, Typ.

Grommet liners cover AV vents

15" Single space trash pullout  
 - (1) 8.75 gallon receptacle  
 - Side to side orientation  
 - Containers are black plastic

30" Double space trash pullout  
 - (2) 8.75 gallon receptacles  
 - Side to side orientation  
 - Containers are black plastic

### Credenza Notes

- Pulls are 45 degrees inside bevel
- All drawers have a beveled pull on back edge of each front
- Top drawer has bevel on top edge, bottom drawer has bevel at bottom edge
- All drawers are equipped with full extension slides
- All doors are equipped with self-closing hinges
- All credenza top material options are secured to the case with silicone except full clear glass (FG GC00)
- Full clear glass (FG GC00) sets on top of 1/16" bumpers located on top of case
- Trash option is pull-out only
- Pull-out trash unit is a Rev-A-Shelf product.

### Audio Visual Requirements:

- Coordinate AV requirements with the interior clearance dimensions provided below to ensure fit. All AV cases have air vent grommet at the bottom front and an open back w/3" border. Consult with your AV contractor for specific component requirements. Custom solutions are available on request

- Conference height 30" Bay:  
 25.75" width x 19" depth x 21.5" height
- Buffet height 30" Bay:  
 25.75" width x 19" depth x 26.5" height

- Conference height 36" Bay:  
 31.75" width x 19" depth x 21.5" height
- Buffet height 36" bay:  
 31.75" width x 19" depth x 26.5" height

# General Specifications

## Conference Height Credenzas: 29"

### Configurations: 15" & 30" Modules

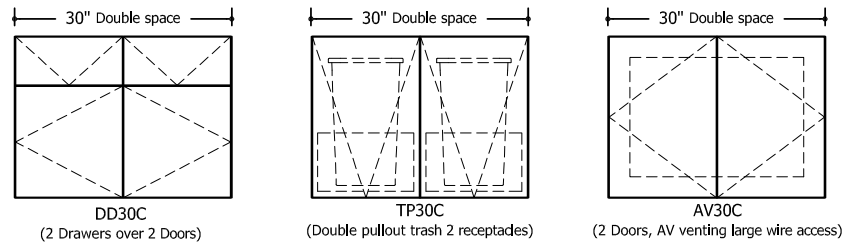
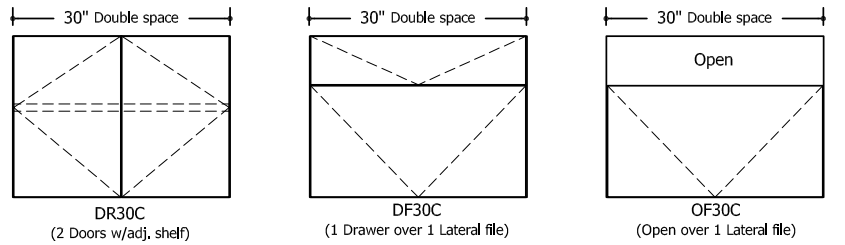
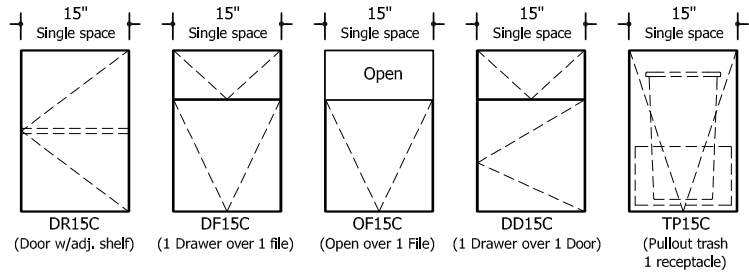
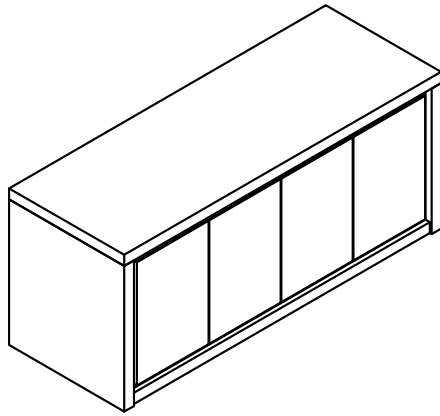



# General Specifications

## Conference Height Credenzas: 29"

### Configurations: 18" & 36" Modules

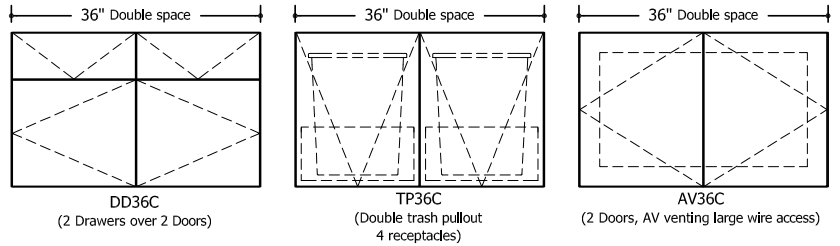
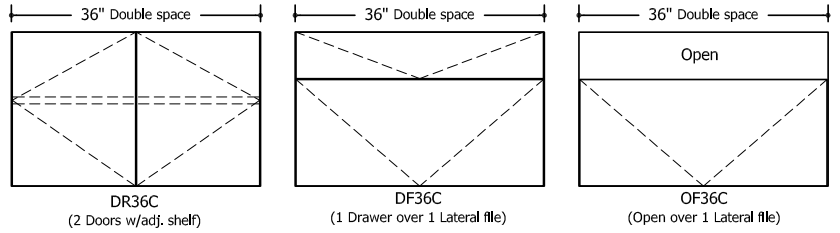
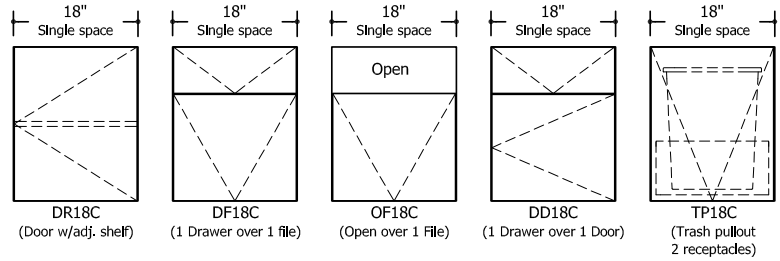
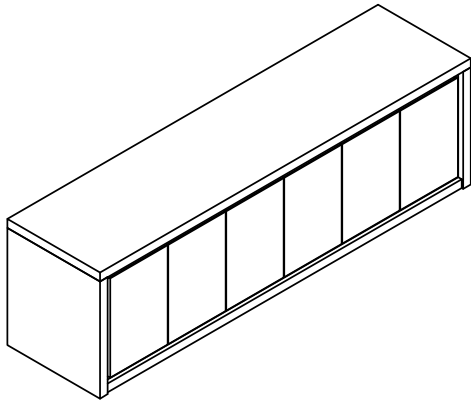

# General Specifications

## Buffet Height Credenzas: 34"

### Configurations: 15" & 30" Modules

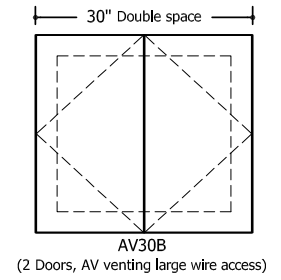
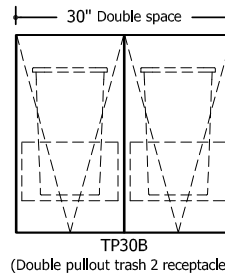
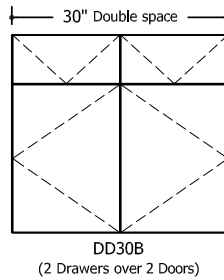
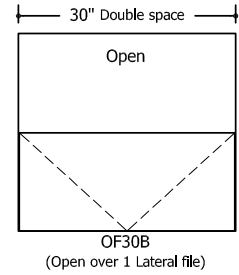
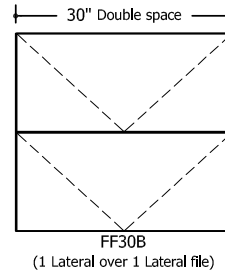
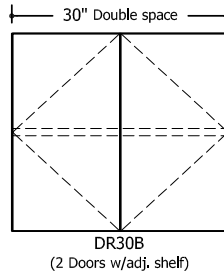
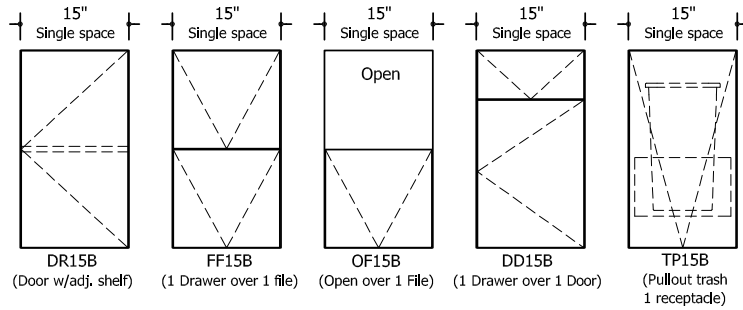
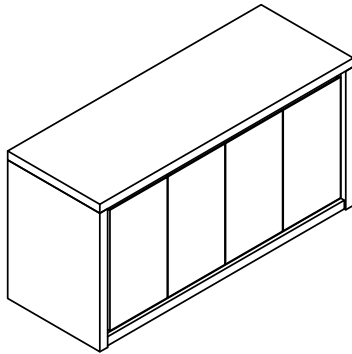

# General Specifications

## Buffet Height Credenzas: 34"

### Configurations: 18" & 36" Modules

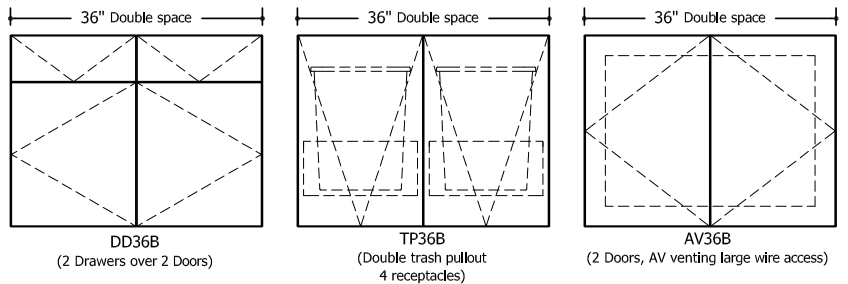
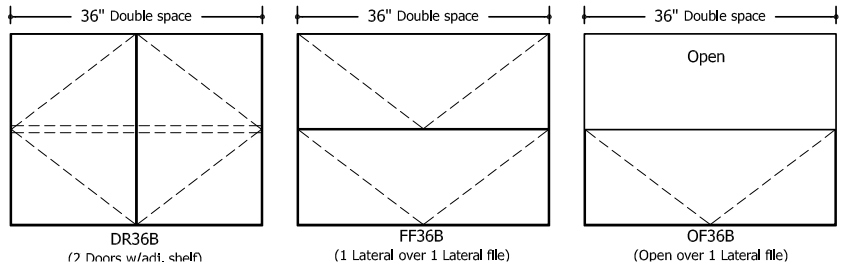
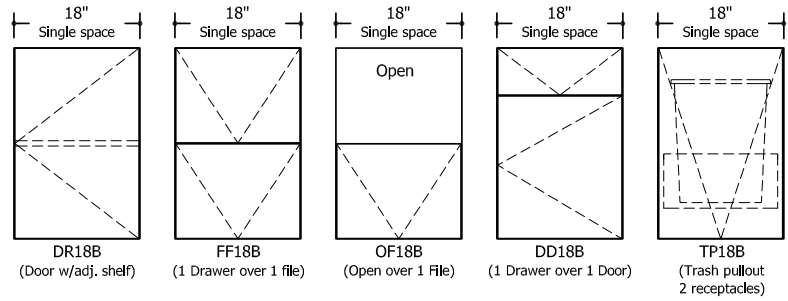
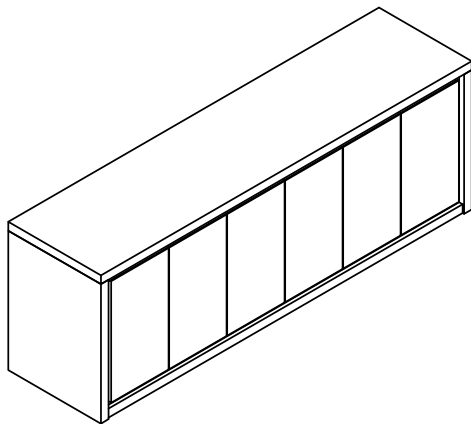

# Highline Fifty Credenzas

## Conference Height Credenzas

24" Deep, 29" High

**Credenzas that are over 96" will have a knockdown added.  
Knockdown location may vary depending on credenza bay selections.**

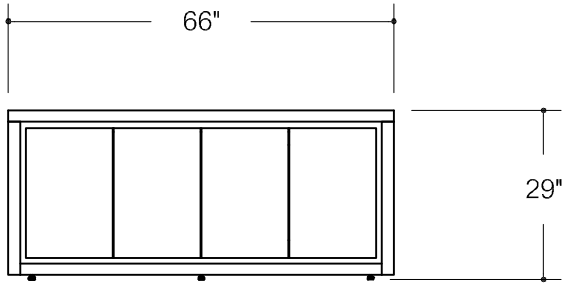

**03C66C**

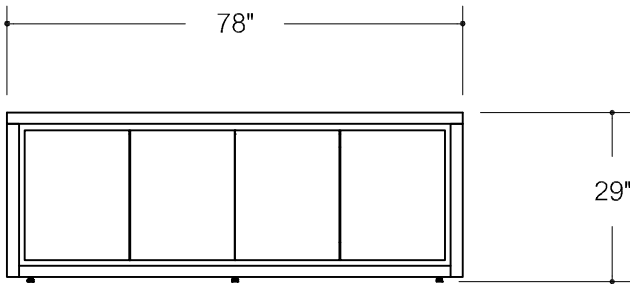

**03C78C**

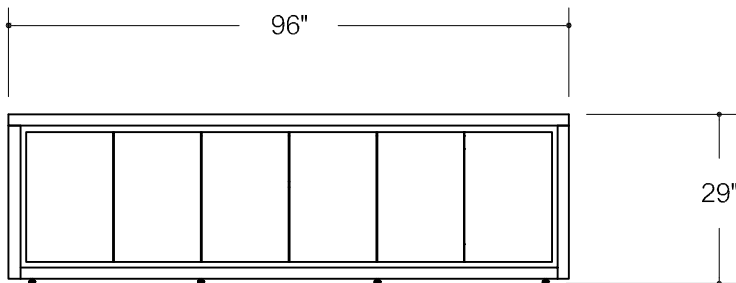

**03C96C**

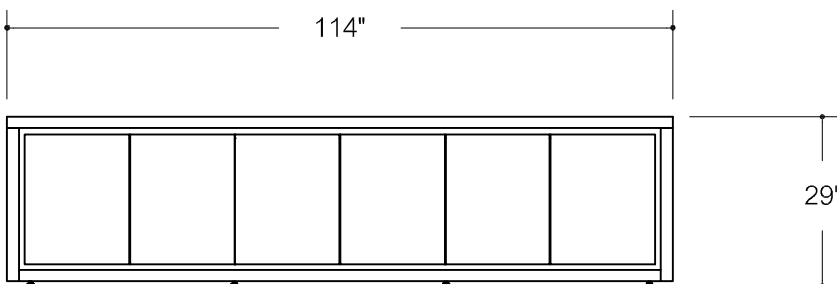

**03C114C**

# Highline Fifty Credenzas

## Conference Height Credenzas

24" Deep, 29" High

Starting price in SL finish

Pattern No.	Starting Price	T1__ Shell	T2__ Shell	HG__ Shell	MC__/ PM01/ PM02 Reveal	PM03 Reveal	T1__ Interior	T2__ Interior	T1__ Face	T2__ Face	HG__ Face
<b>03C66C</b>	\$16,171	\$2,450	\$4,239	\$8,204	\$791	\$791	\$1,489	\$1,789	\$730	\$1,420	\$3,084
<b>03C78C</b>	17,467	2,594	4,554	8,984	791	791	1,669	3,284	730	1,420	3,084
<b>03C96C</b>	20,954	2,858	5,084	10,185	791	791	2,134	4,166	1,053	2,052	5,014
<b>03C114C</b>	22,846	3,067	5,540	11,398	909	909	2,279	4,645	1,120	2,294	5,384

### Top Upcharges

#### Pattern

Pattern No.	GC00 Top	GC__ Top	GE__ Top	CS01 Top
<b>03C66C</b>	\$2,821	\$3,360	\$3,635	\$3,720
<b>03C78C</b>	2,829	3,368	3,644	3,730
<b>03C96C</b>	3,513	4,158	4,509	4,691
<b>03C114C</b>	5,394	6,301	6,753	6,887

### Configuration Upcharges

Pattern No.	Description	Price	Pattern No.	Description	Price
<b>03DR15C</b>	15" Door w/ Adjustable Shelf	\$-	<b>03DR18C</b>	18" Door w/ Adjustable Shelf	\$-
<b>03DF15C</b>	15" Lateral File over Lateral File	234	<b>03DF18C</b>	18" Lateral File over Lateral File	239
<b>03OF15C</b>	15" Open Over File	218	<b>03OF18C</b>	18" Open Over File	226
<b>03DD15C</b>	15" Drawer Over Door	285	<b>03DD18C</b>	18" Drawer Over Door	292
<b>03TP15C</b>	15" Trash Pull Out	737	<b>03TP18C</b>	18" Trash Pull Out	744
<b>03DR30C</b>	30" Doors w/ Adjustable Shelf	-	<b>03DR36C</b>	36" Doors w/ Adjustable Shelf	-
<b>03DF30C</b>	30" File Over File	466	<b>03DF36C</b>	36" File Over File	482
<b>03OF30C</b>	30" Open Over File	436	<b>03OF36C</b>	36" Open Over File	452
<b>03DD30C</b>	30" Drawer Over Doors	573	<b>03DD36C</b>	36" Drawer Over Doors	588
<b>03TP30C</b>	30" Trash Pull Out	1,473	<b>03TP36C</b>	36" Trash Pull Out	1,489
<b>03AV30C</b>	30" AV Case	526	<b>03AV36C</b>	36" AV Case	630

# Highline Fifty Credenzas

## Buffet Height Credenzas

24" Deep, 34" High

**Credenzas that are over 96" will have a knockdown added.  
Knockdown location may vary depending on credenza bay selections.**

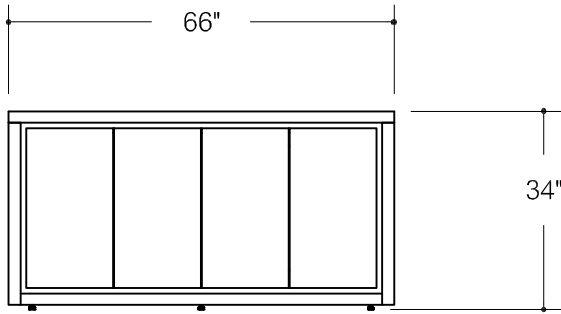

**03C66B**

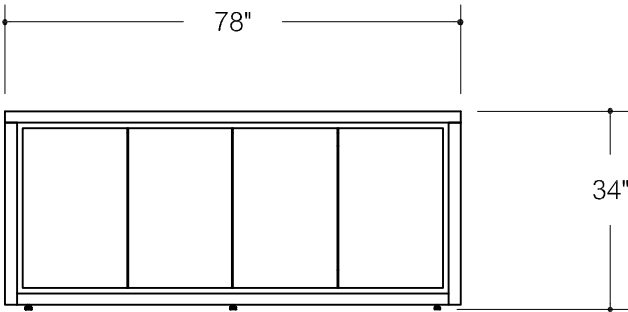

**03C78B**

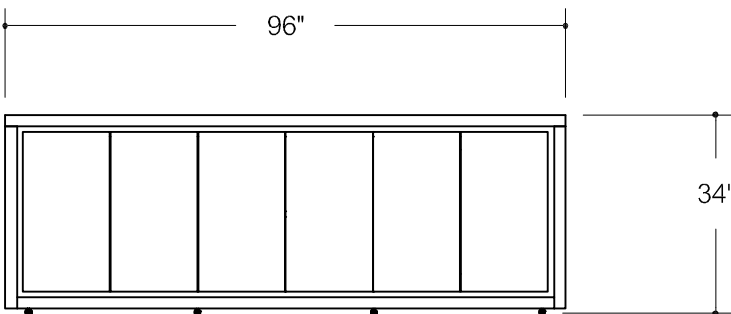

**03C96B**

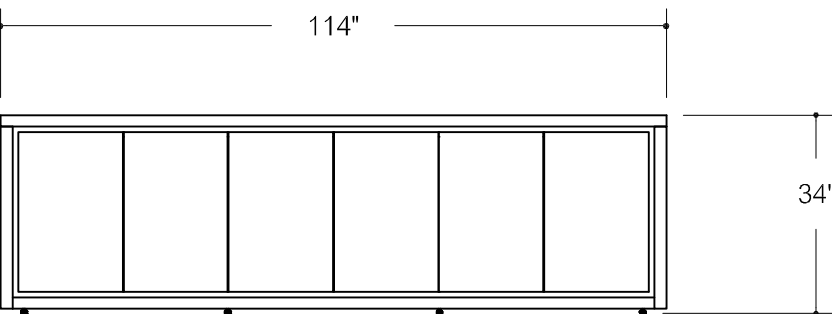

**03C114B**

# Highline Fifty Credenzas

## Buffet Height Credenzas

24" Deep, 34" High

Starting price in SL finish

Pattern No.	Starting Price	T1__ Shell	T2__ Shell	HG__ Shell	MC__/ PM01/ PM02	PM03 Reveal	T1__ Interior	T2__ Interior	T1__ Face	T2__ Face	HG__ Face
					Reveal						
<b>03C66B</b>	\$16,171	\$2,450	\$4,239	\$8,204	\$791	\$791	\$1,489	\$1,789	\$730	\$1,420	\$3,084
<b>03C78B</b>	17,467	2,594	4,554	8,984	791	791	1,669	3,284	730	1,420	3,084
<b>03C96B</b>	20,954	2,858	5,084	10,185	791	791	2,134	4,166	1,053	2,052	5,014
<b>03C114B</b>	22,846	3,067	5,540	11,398	909	909	2,279	4,645	1,120	2,294	5,384

### Top Upcharges

#### Pattern

Pattern No.	GC00 Top	GC__ Top	GE__ Top	CS01 Top
<b>03C66B</b>	\$2,821	\$3,360	\$3,635	\$3,720
<b>03C78B</b>	2,829	3,368	3,644	3,730
<b>03C96B</b>	3,513	4,158	4,509	4,691
<b>03C114B</b>	5,394	6,301	6,753	6,887

### Configuration Upcharges

Pattern No.	Description	Price	Pattern No.	Description	Price
<b>03DR15B</b>	15" Door w/ Adjustable Shelf	\$-	<b>03DR18B</b>	18" Door w/ Adjustable Shelf	\$-
<b>03FF15B</b>	15" Lateral File over Lateral File	234	<b>03FF18B</b>	18" Lateral File over Lateral File	239
<b>03OF15B</b>	15" Open Over File	218	<b>03OF18B</b>	18" Open Over File	226
<b>03DD15B</b>	15" Drawer Over Door	285	<b>03DD18B</b>	18" Drawer Over Door	292
<b>03TP15B</b>	15" Trash Pull Out	737	<b>03TP18B</b>	18" Trash Pull Out	744
<b>03DR30B</b>	30" Doors w/ Adjustable Shelf	-	<b>03DR36B</b>	36" Doors w/ Adjustable Shelf	-
<b>03FF30B</b>	30" File Over File	466	<b>03FF36B</b>	36" File Over File	482
<b>03OF30B</b>	30" Open Over File	436	<b>03OF36B</b>	36" Open Over File	452
<b>03DD30B</b>	30" Drawer Over Doors	573	<b>03DD36B</b>	36" Drawer Over Doors	588
<b>03TP30B</b>	30" Trash Pull Out	1,473	<b>03TP36B</b>	36" Trash Pull Out	1,489
<b>03AV30B</b>	30" AV Case	526	<b>03AV36B</b>	36" AV Case	630





# Highline Collection

## Highline Twenty-Five Credenzas



**DATESWEISER**

# General Specifications

## Highline Twenty-Five Credenzas

### Credenza Elevations & Optional Tops

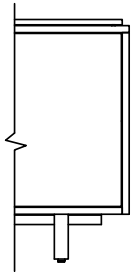

Optional Top  
3/4" Caesarstone

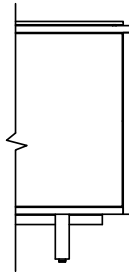

Optional Top  
1/2" Corian

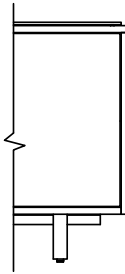

Optional Top  
3/8" Glass

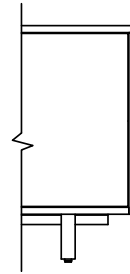

Optional Top  
None

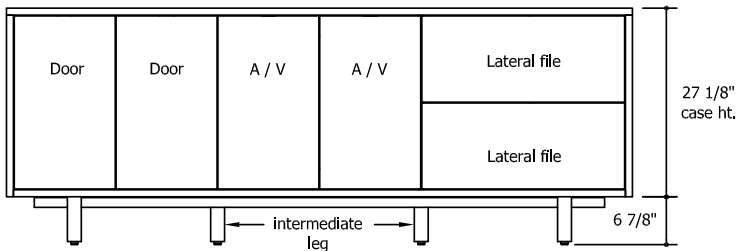
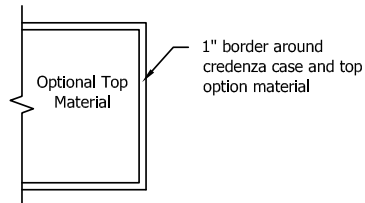

Buffet Height Credenza

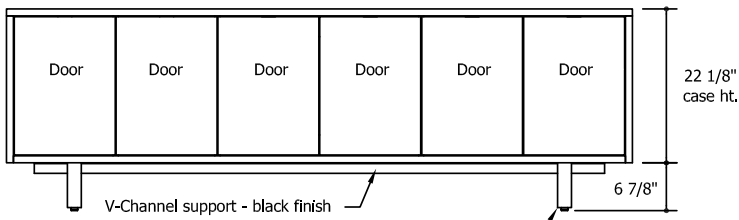
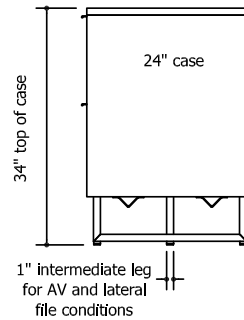

Conference Height Credenza

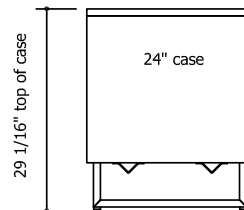

# General Specifications

## Highline Twenty-Five Credenzas

### Credenza Case Details

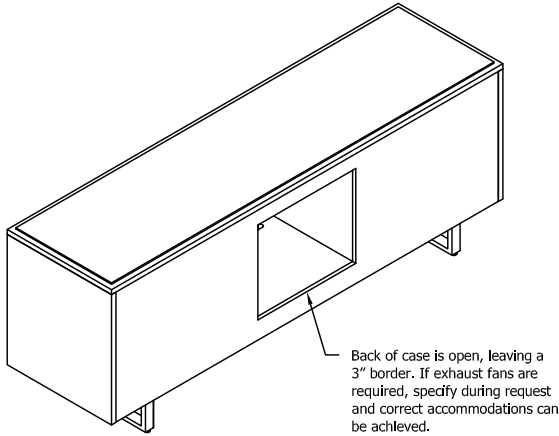

Back of Credenza

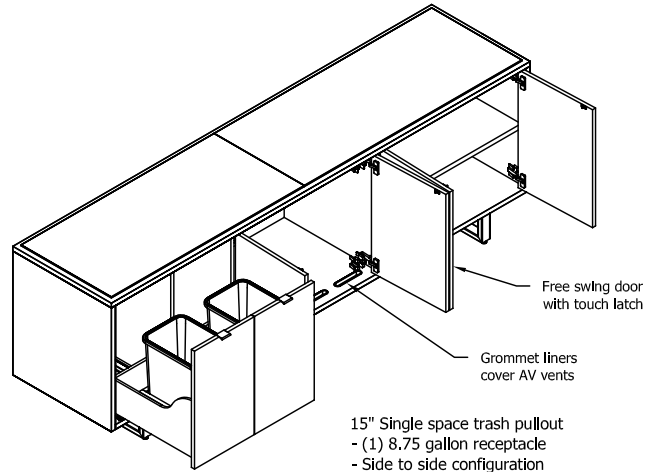

Front of Credenza

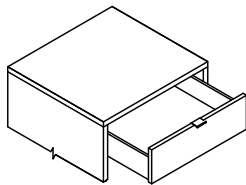

Drawer with 2" tab pull



2" tab pull

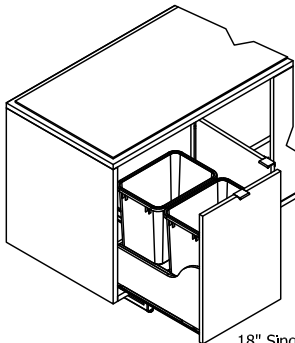

18" Single space trash pullout  
- (2) 8.75 gallon receptacles  
- Front to back orientation  
- Containers are black plastic

36" Double space trash pullout  
- (4) 8.75 gallon receptacles  
- Front to back orientation  
- Containers are black plastic

#### Credenza Notes:

- 2" metal pulls to compliment metal legs
- All drawers have a 2" tab pull that is located in the center of the top edge of each front
- All drawers use full extension slides
- All doors use free swing hinges and touch latches.
- All credenza top material options are secured to the case with silicone except full clear glass (FG GC00)
- Full clear glass (FG CG00) sets on top of 1/16" bumpers located on top of case
- Trash option is pull-out only
- Pull-out trash unit is a Rev-A-Shelf product.

#### Audio Visual Requirements:

- Coordinate AV requirements with the interior clearance dimensions provided below to ensure fit. All AV cases have air vent grommet at the bottom front and an open back width 3" border. Consult with your AV contractor for specific component requirements. Custom solutions are available on request

- Conference height 30" Bay:  
25.15" width x 21.25" depth x 19.18" height

- Buffet height 30" Bay:  
25.15" width x 21.25" depth x 24.18" height

- Conference height 36" Bay:  
31.13" width x 21.25" depth x 19.18" height

- Buffet height 36" Bay:  
31.13" width x 21.25" depth x 24.18" height

# General Specifications

## Conference Height Credenzas: 29"

### Configurations: 15" & 30" Modules

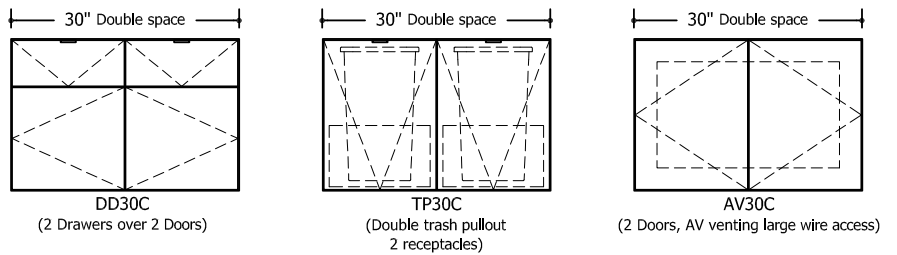
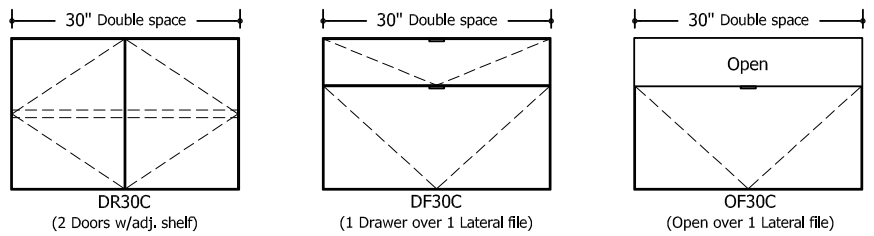
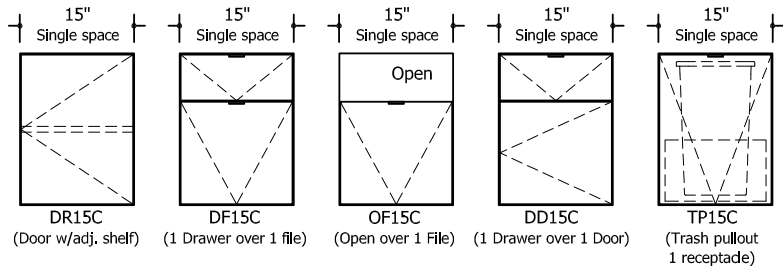
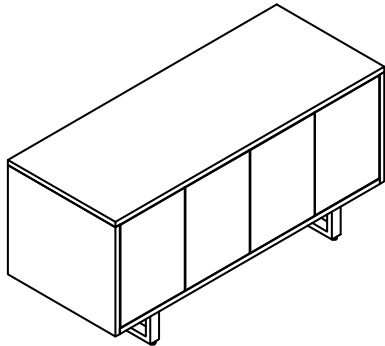

# General Specifications

## Conference Height Credenzas: 29"

### Configurations: 18" & 36" Modules

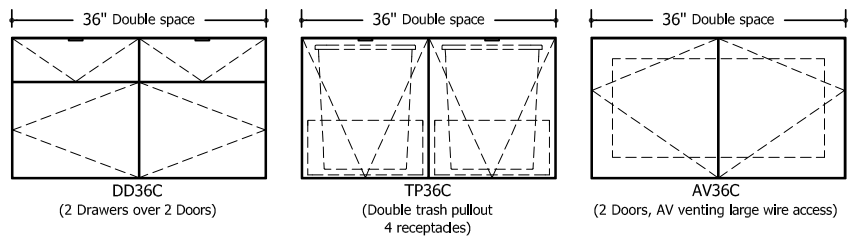
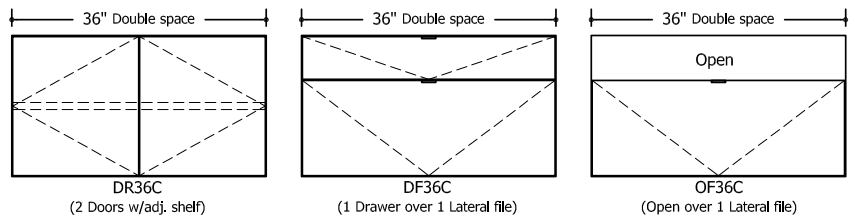
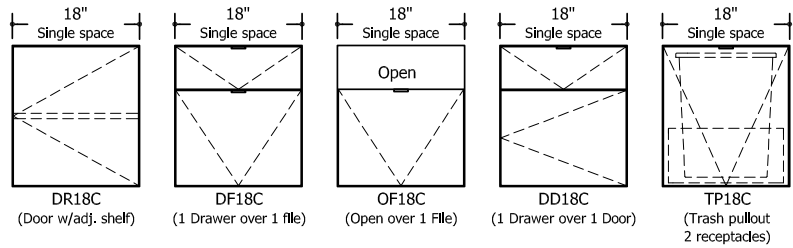
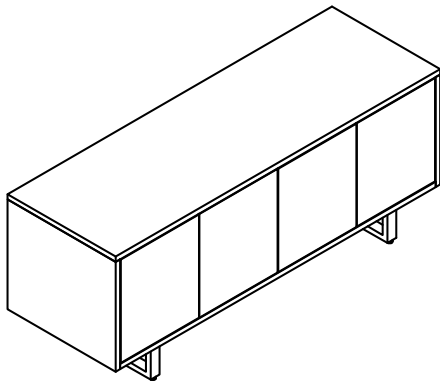

# General Specifications

## Buffet Height Credenzas: 34"

### Configurations: 15" & 30" Modules

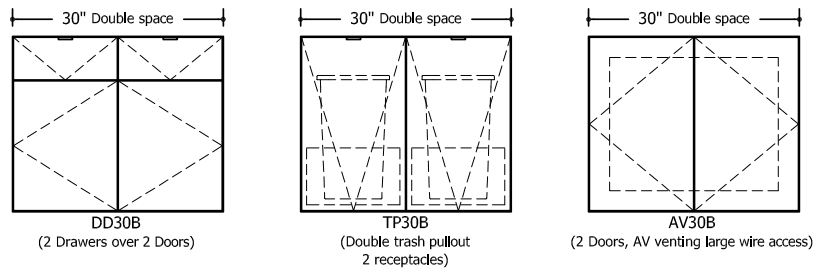
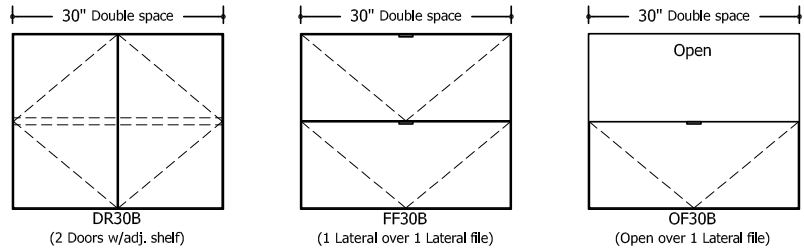
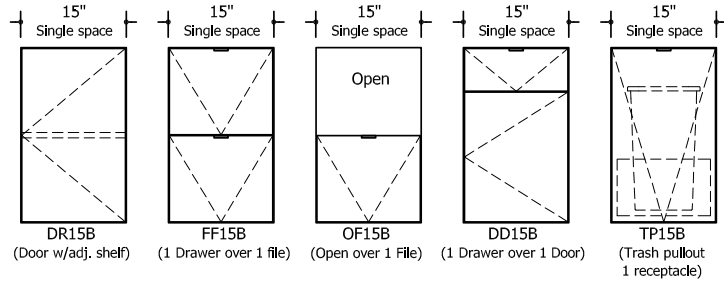
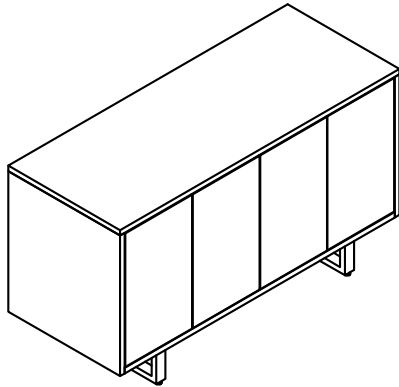

# General Specifications

## Buffet Height Credenzas: 34"

### Configurations: 18" & 36" Modules

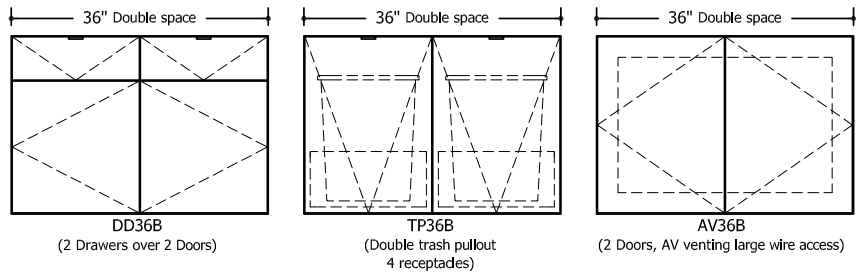
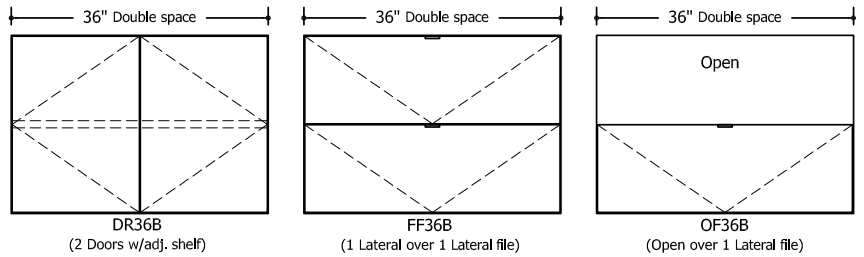
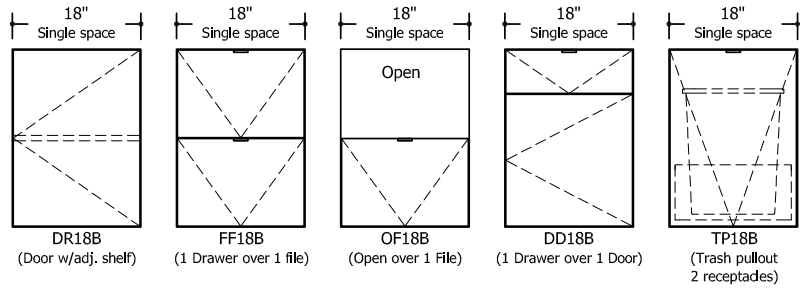
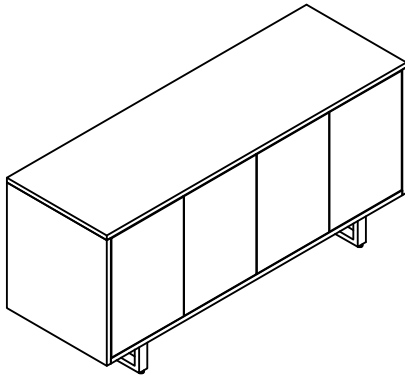

# Highline Twenty-Five Credenzas

## Conference Height Credenzas

24" Deep, 29" High

**Credenzas that are over 96" will have a knockdown added.  
Knockdown location may vary depending on credenza bay selections.**

---

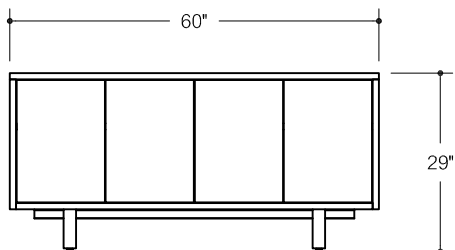

**04C60C**

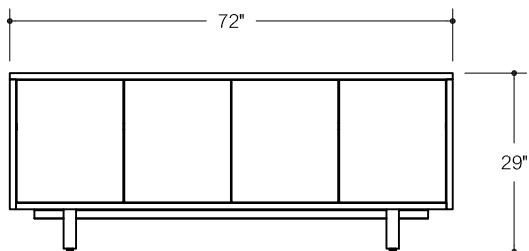

**04C72C**

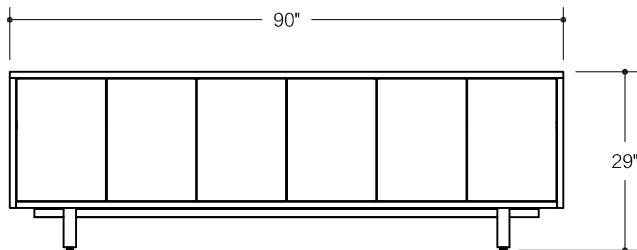

**04C90C**

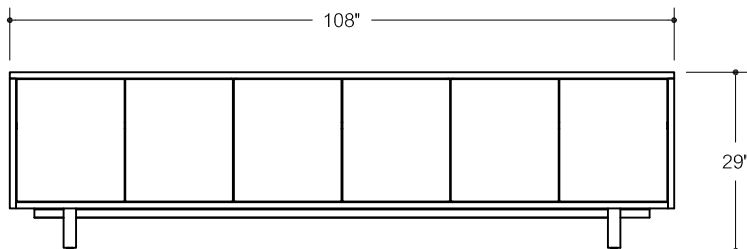

**04C108C**



# Highline Twenty-Five Credenzas

## Conference Height Credenzas

24" Deep, 29" High

Starting price in SL finish and MC base

L	Pattern No.	Starting Price	T1__ Shell	T2__ Shell	HG__ Shell	PM01/ PM02 Base	PM03 Base	T1__ Face	T2__ Face	HG__ Face
60"	<b>04C60C</b>	\$11,394	\$2,394	\$5,175	\$11,417	\$474	\$887	\$594	\$1,295	\$2,854
72"	<b>04C72C</b>	12,003	2,624	5,664	13,105	474	887	655	1,420	3,277
90"	<b>04C90C</b>	14,618	3,293	7,179	15,469	474	887	825	1,800	3,864
108"	<b>04C108C</b>	15,562	3,620	8,102	17,995	474	887	907	2,030	4,498

### Top Upcharges

#### Pattern

No.	GC00 Top	GC__ Top	GE__ Top	CS01 Top
<b>04C60C</b>	\$2,670	\$3,116	\$3,354	\$3,501
<b>04C72C</b>	2,804	3,413	3,695	4,065
<b>04C90C</b>	3,072	3,871	4,214	5,079
<b>04C108C</b>	3,872	5,546	5,953	6,245

### Configuration Upcharges

Pattern No.	Description	Price	Pattern No.	Description	Price
<b>04DR15C</b>	15" Door w/ Adjustable Shelf	\$-	<b>04DR18C</b>	18" Door w/ Adjustable Shelf	\$-
<b>04DF15C</b>	15" Lateral File over Lateral File	265	<b>04DF18C</b>	18" Lateral File over Lateral File	296
<b>04OF15C</b>	15" Open Over File	223	<b>04OF18C</b>	18" Open Over File	260
<b>04DD15C</b>	15" Drawer Over Door	440	<b>04DD18C</b>	18" Drawer Over Door	472
<b>04TP15C</b>	15" Trash Pull Out	770	<b>04TP18C</b>	18" Trash Pull Out	814
<b>04DR30C</b>	30" Doors w/ Adjustable Shelf	-	<b>04DR36C</b>	36" Doors w/ Adjustable Shelf	-
<b>04DF30C</b>	30" File Over File	528	<b>04DF36C</b>	36" File Over File	587
<b>04OF30C</b>	30" Open Over File	446	<b>04OF36C</b>	36" Open Over File	523
<b>04DD30C</b>	30" Drawer Over Doors	877	<b>04DD36C</b>	36" Drawer Over Doors	944
<b>04TP30C</b>	30" Trash Pull Out	1,537	<b>04TP36C</b>	36" Trash Pull Out	1,629
<b>04AV30C</b>	30" AV Case	523	<b>04AV36C</b>	36" AV Case	624

# Highline Twenty-Five Credenzas

## Buffet Height Credenzas

24" Deep, 34" High

**Credenzas that are over 96" will have a knockdown added.  
Knockdown location may vary depending on credenza bay selections.**

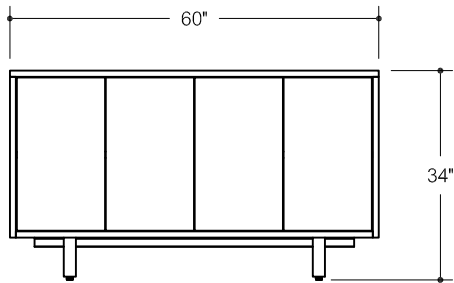

**04C60B**

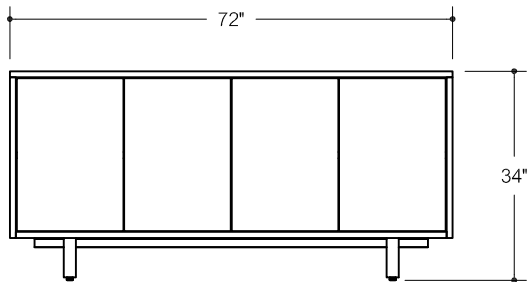

**04C72B**

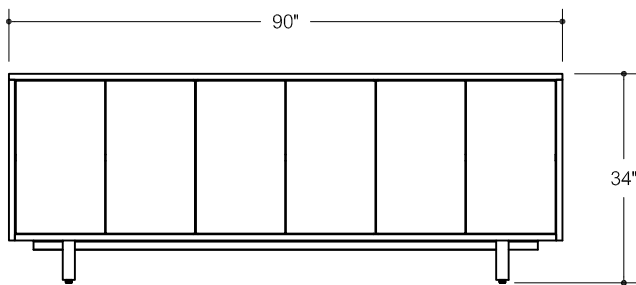

**04C90B**

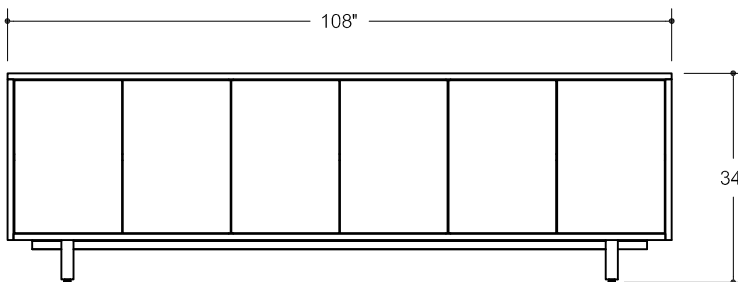

**04C108B**

# Highline Twenty-Five Credenzas

## Buffet Height Credenzas

24" Deep, 34" High

Starting price in SL finish and MC base

L	Pattern No.	Starting Price	PM01/							
			T1__ Shell	T2__ Shell	HG__ Shell	PM02 Base	PM03 Base	T1__ Face	T2__ Face	HG__ Face
60"	<b>04C60B</b>	\$11,394	\$2,394	\$5,175	\$11,417	\$474	\$887	\$594	\$1,295	\$2,854
72"	<b>04C72B</b>	12,003	2,624	5,664	13,105	474	887	655	1,420	3,277
90"	<b>04C90B</b>	14,618	3,293	7,179	15,469	474	887	825	1,800	3,864
108"	<b>04C108B</b>	15,562	3,620	8,102	17,995	474	887	907	2,030	4,498

### Top Upcharges

#### Pattern

No.	GC00 Top	GC__ Top	GE__ Top	CS01 Top
<b>04C60B</b>	\$2,670	\$3,116	\$3,354	\$3,501
<b>04C72B</b>	2,804	3,413	3,695	4,065
<b>04C90B</b>	3,072	3,871	4,214	5,079
<b>04C108B</b>	3,872	5,546	5,953	6,245

### Configuration Upcharges

Pattern No.	Description	Price	Pattern No.	Description	Price
<b>04DR15B</b>	15" Door w/ Adjustable Shelf	\$-	<b>04DR18B</b>	18" Door w/ Adjustable Shelf	\$-
<b>04FF15B</b>	15" Lateral File over Lateral File	265	<b>04FF18B</b>	18" Lateral File over Lateral File	296
<b>04OF15B</b>	15" Open Over File	223	<b>04OF18B</b>	18" Open Over File	260
<b>04DD15B</b>	15" Drawer Over Door	440	<b>04DD18B</b>	18" Drawer Over Door	472
<b>04TP15B</b>	15" Trash Pull Out	770	<b>04TP18B</b>	18" Trash Pull Out	814
<b>04DR30B</b>	30" Doors w/ Adjustable Shelf	-	<b>04DR36B</b>	36" Doors w/ Adjustable Shelf	-
<b>04FF30B</b>	30" File Over File	528	<b>04FF36B</b>	36" File Over File	587
<b>04OF30B</b>	30" Open Over File	446	<b>04OF36B</b>	36" Open Over File	523
<b>04DD30B</b>	30" Drawer Over Doors	877	<b>04DD36B</b>	36" Drawer Over Doors	944
<b>04TP30B</b>	30" Trash Pull Out	1,537	<b>04TP36B</b>	36" Trash Pull Out	1,629
<b>04AV30B</b>	30" AV Case	523	<b>04AV36B</b>	36" AV Case	624



# Highline Collection

## Highline Vector Conference Tables



**DATESWEISER**

# General Specifications

## Highline Vector Conference Tables

### Power & Connectivity Layout

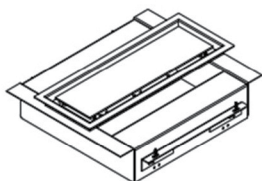

DOUBLE-HINGED TOPMOUNT

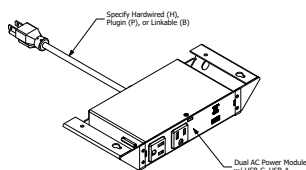

UNDER-MOUNT BOX

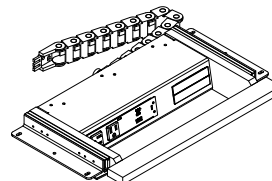

POWER DRAWER

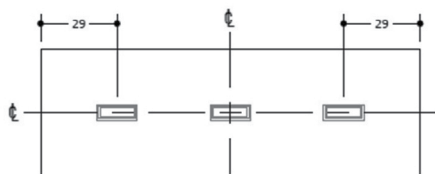

144-240" WIDE

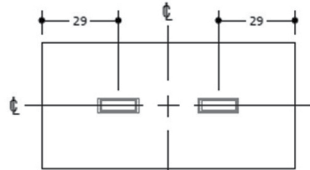

96-132" WIDE

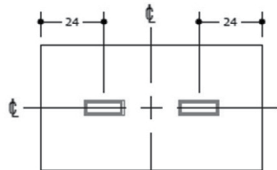

72-84" WIDE

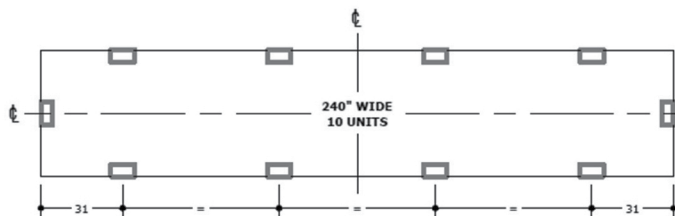

240" WIDE  
10 UNITS

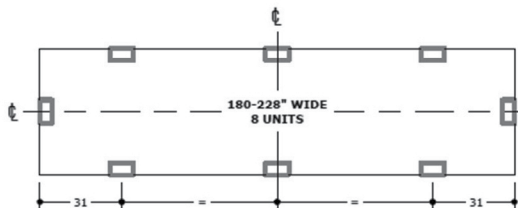

180-228" WIDE  
8 UNITS

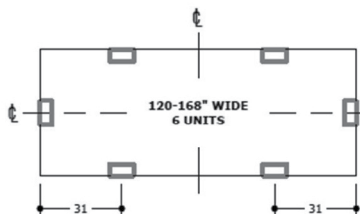

120-168" WIDE  
6 UNITS

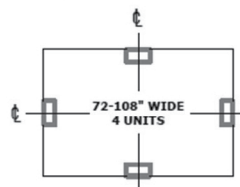

72-108" WIDE  
4 UNITS

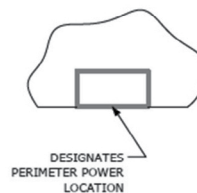

# General Specifications

## Highline Vector Conference Tables

### Power & Connectivity / Base Details

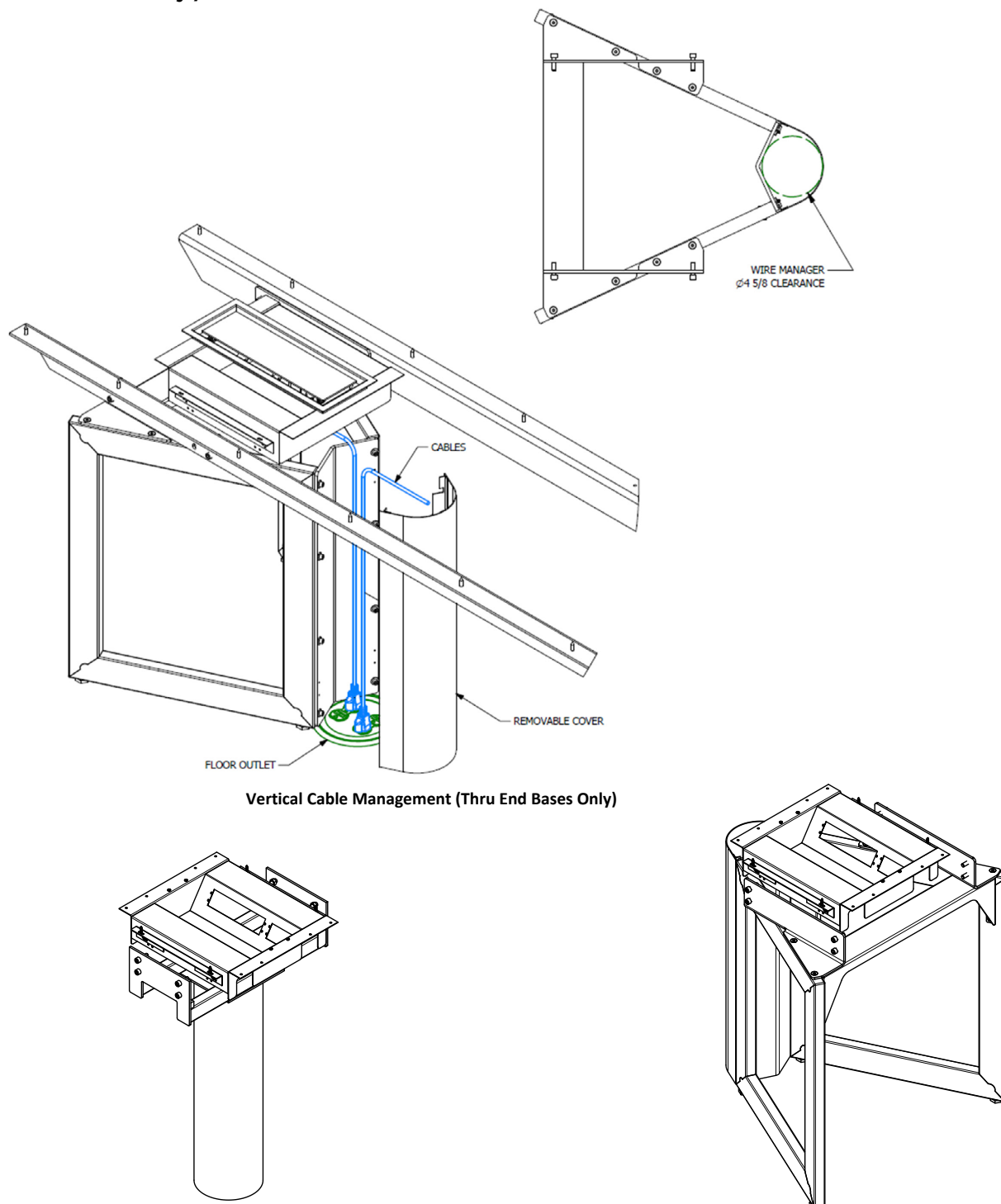

Vertical Cable Management (Thru End Bases Only)

# General Specifications

## Highline Vector Conference Tables

### Edge Profile Details

#### Standard Edge Profiles

##### Flat Profile (F1)

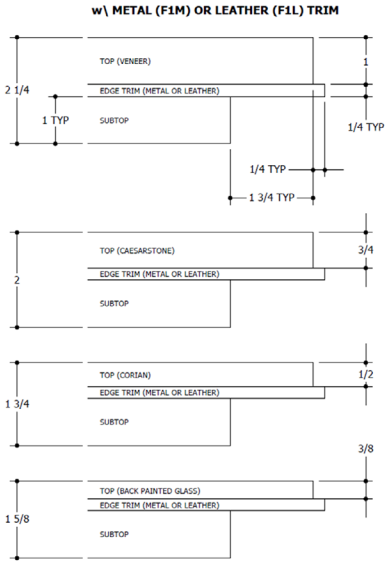

##### Slab Profile (SF)

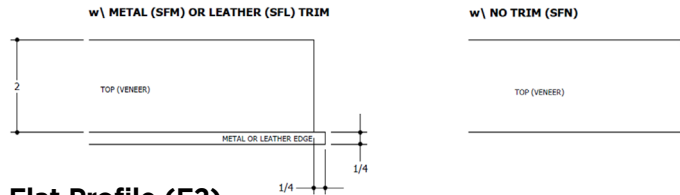

##### Flat Profile (F2)

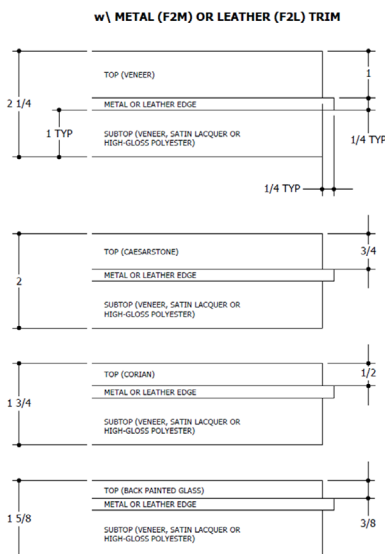

#### Upcharge Edge Profiles

##### Rounded Profile (R1)

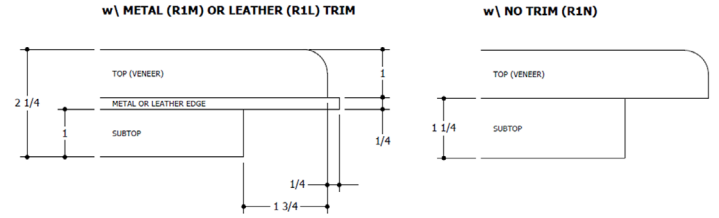

##### Bullnose Profile (B1)

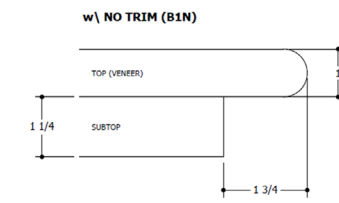

##### Rounded Profile (R2)

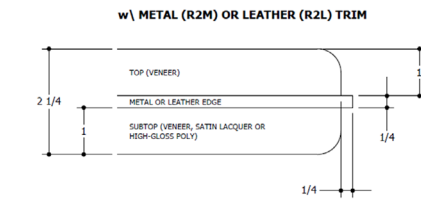

##### Tapered Profile (TP2)

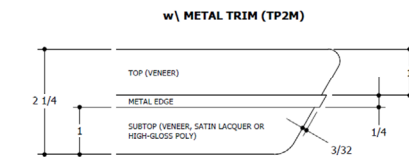



# General Specifications

## Highline Vector Conference Tables

### Edge Profile Upcharges

D	W	1 Layer Edge Profile	2 Layer Edge Profile	D	W	1 Layer Edge Profile	2 Layer Edge Profile
42"	84"	\$2,237	\$4,474	54"	120"	3,088	6,177
42"	96"	2,450	4,900	54"	132"	3,303	6,604
42"	108"	2,663	5,325	54"	144"	3,514	7,029
42"	120"	2,875	5,751	54"	156"	3,728	7,456
42"	132"	3,089	6,178	54"	168"	3,941	7,882
42"	144"	3,303	6,604	54"	180"	4,152	8,308
42"	156"	3,516	7,030	54"	192"	4,368	8,733
42"	168"	3,729	7,456	54"	204"	4,580	9,160
42"	180"	3,941	7,883	54"	216"	4,793	9,587
42"	192"	4,155	8,307	54"	228"	5,006	10,013
42"	204"	4,366	8,733	54"	240"	5,220	10,438
42"	216"	4,581	9,161	60"	120"	3,195	6,391
42"	228"	4,794	9,587	60"	132"	3,409	6,817
42"	240"	5,006	10,012	60"	144"	3,621	7,244
48"	84"	2,344	4,686	60"	156"	3,835	7,669
48"	96"	2,556	5,112	60"	168"	4,048	8,094
48"	108"	2,769	5,539	60"	180"	4,261	8,521
48"	120"	2,984	5,966	60"	192"	4,474	8,948
48"	132"	3,195	6,391	60"	204"	4,686	9,373
48"	144"	3,408	6,818	60"	216"	4,900	9,799
48"	156"	3,622	7,243	60"	228"	5,112	10,225
48"	168"	3,835	7,670	60"	240"	5,326	10,652
48"	180"	4,048	8,095	72"	144"	3,835	7,669
48"	192"	4,261	8,521	72"	156"	4,047	8,095
48"	204"	4,474	8,947	72"	168"	4,261	8,522
48"	216"	4,686	9,375	72"	180"	4,472	8,947
48"	228"	4,900	9,800	72"	192"	4,686	9,374
48"	240"	5,113	10,225	72"	204"	4,899	9,800
54"	84"	2,450	4,900	72"	216"	5,113	10,226
54"	96"	2,664	5,325	72"	228"	5,325	10,652
54"	108"	2,876	5,752	72"	240"	5,538	11,077

# Highline Vector Conference Tables

## 42", 48" & 54" Deep Conference Tables

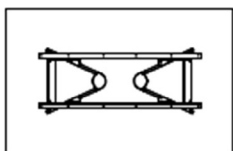
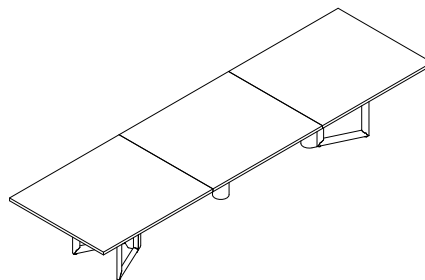

**84L**  
SEATS 6

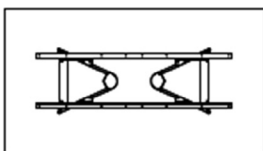

**96L**  
SEATS 6-8

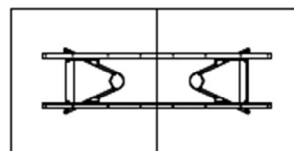

**108L**  
SEATS 8

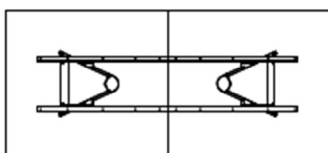

**120L**  
SEATS 10

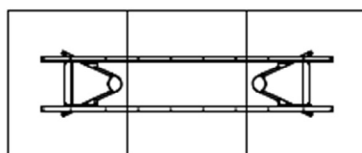

**132L**  
SEATS 10

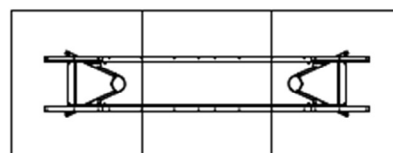

**144L**  
SEATS 10

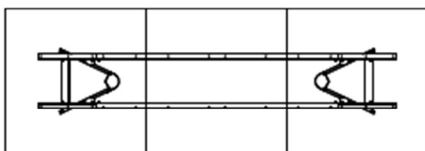

**156L**  
SEATS 10-12

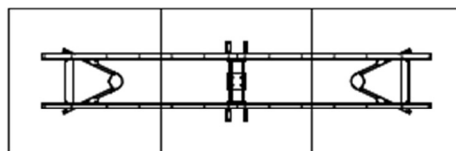

**168L**  
SEATS 12

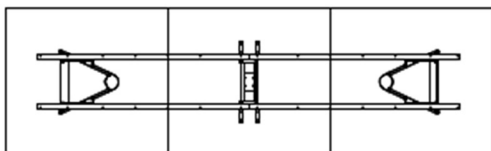

**180L**  
SEATS 14

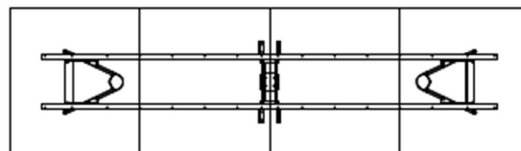

**192L**  
SEATS 14

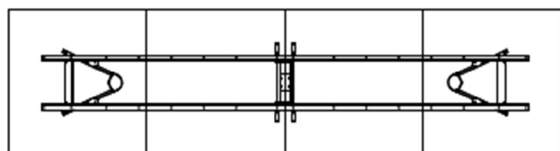

**204L**  
SEATS 14

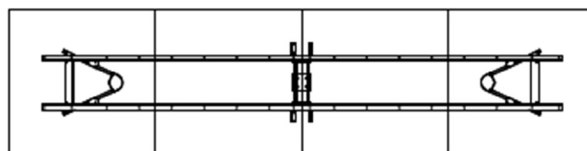

**216L**  
SEATS 16

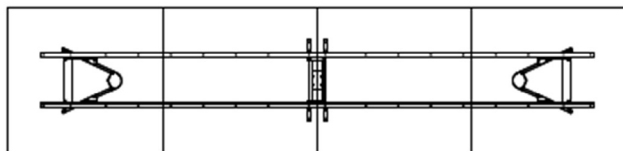

**228L**  
SEATS 16

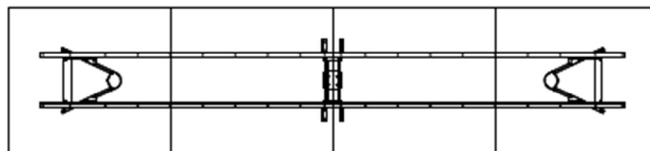

**240L**  
SEATS 18

# Highline Vector Conference Tables

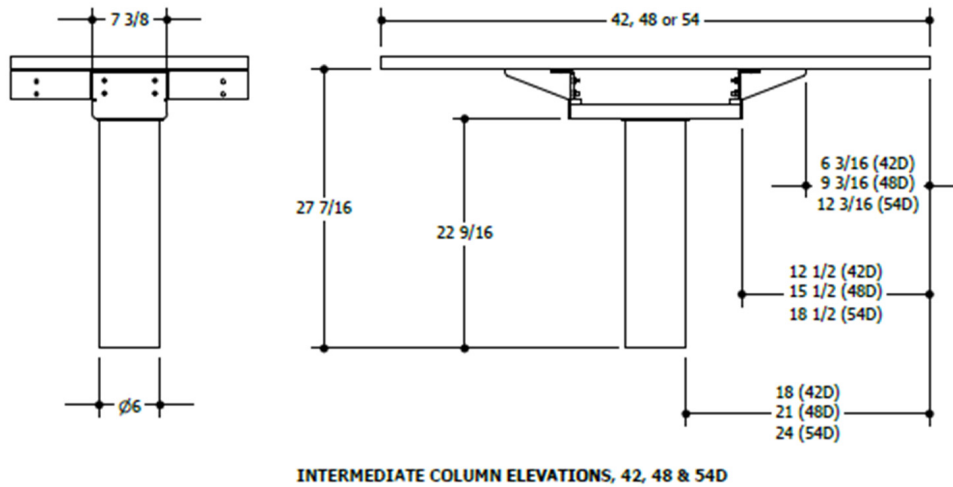
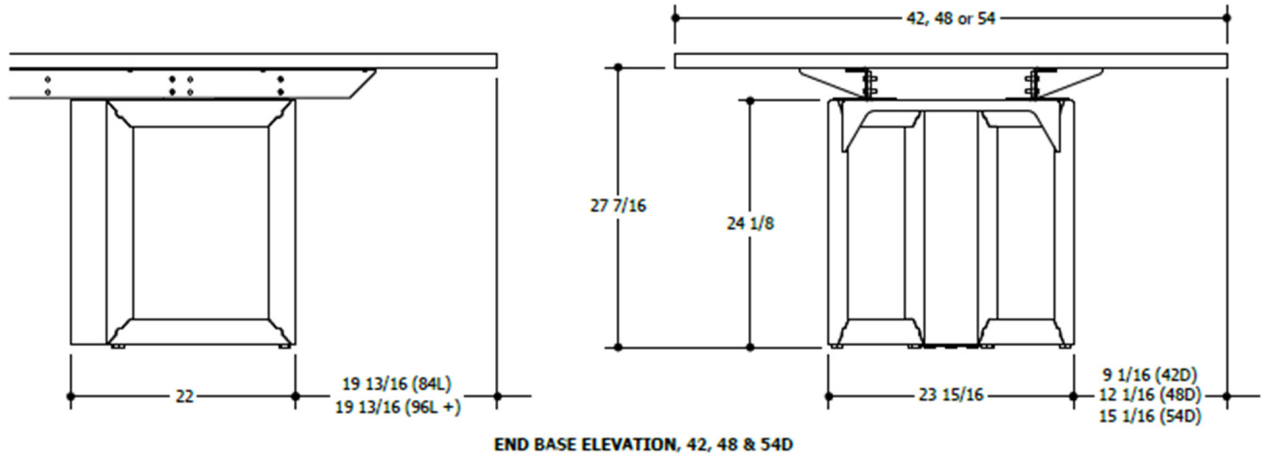
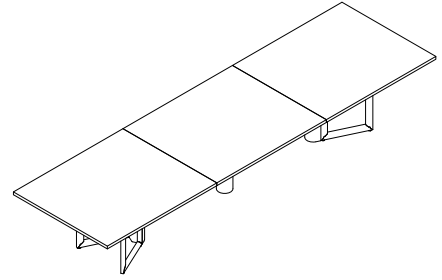

# Rectangular Conference Tables

**42" Deep Tops**  
**1-Layer, Veneer Tops**

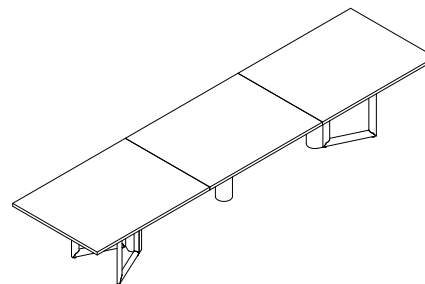

D	W	Pattern No.	T1__ Top	T2__ Top	MC__ Edge Upcharge	PM__ Edge Upcharge	AU__ Edge Upcharge	PM__ Base Upcharge
42"	84"	<b>08VOFR4284VF1</b>	\$15,066	\$15,764	\$2,487	\$3,072	\$4,538	\$2,416
42"	96"	<b>08VOFR4296VF1</b>	15,900	16,697	2,669	3,304	4,906	2,416
42"	108"	<b>08VOFR42108VF1</b>	16,734	17,632	2,852	3,534	5,277	2,416
42"	120"	<b>08VOFR42120VF1</b>	17,567	18,563	3,036	3,765	5,645	2,416
42"	132"	<b>08VOFR42132VF1</b>	18,401	19,497	3,219	4,028	6,015	2,416
42"	144"	<b>08VOFR42144VF1</b>	19,233	20,431	3,403	4,259	6,384	2,416
42"	156"	<b>08VOFR42156VF1</b>	20,069	21,366	3,583	4,488	6,753	2,416
42"	168"	<b>08VOFR42168VF1</b>	22,000	23,397	3,933	4,882	7,288	4,083
42"	180"	<b>08VOFR42180VF1</b>	22,686	24,167	3,930	4,928	7,472	4,083
42"	192"	<b>08VOFR42192VF1</b>	23,370	24,966	3,928	4,973	7,656	4,083
42"	204"	<b>08VOFR42204VF1</b>	24,056	25,752	3,925	5,019	7,841	4,083
42"	216"	<b>08VOFR42216VF1</b>	24,740	26,535	3,922	5,032	8,023	4,083
42"	228"	<b>08VOFR42228VF1</b>	25,425	27,320	3,921	5,110	8,241	4,083
42"	240"	<b>08VOFR42240VF1</b>	26,112	28,106	3,916	5,153	8,391	4,083

Order Code	Specification Information	Refer To Accessories Section	Pricing Tiers
Example: <b>08VOFR4284VF1M-T003-PM01-MC01-GM2-MC01-UCO</b>	To order please specify pattern number including:	Please refer to Accessories section, <a href="#">page 213</a> for power details.	Please refer to Materials and Finish <a href="#">page 9</a> for specification details.
<b>08</b> Highline Collection	1. Top finish	<b>Grommet options available in these finishes:</b>	T1 and T2 pricing includes powder coated base finish.
<b>VOF</b> Vector Base	2. Trim Finish (only applies if trim type is metal or leather)	Powder coated	There is an upcharge for plated base finishes as highlighted above.
<b>R</b> Rectangular	3. Base finish	Premium (Polished Chrome, Satin Nickel or Oil Rubbed Bronze)	For additional stone options and pricing please contact your sales representative."
<b>42</b> Depth	4. Grommet option	<b>Power Box Options</b>	
<b>84</b> Width	5. Grommet finish (only applies if grommets are selected)	<b>Code: Description:</b>	
<b>V</b> Veneer	6. Power box option	NP No Power	
<b>F1</b> 1 Layer-Flat w/ Trim	7. Table-top power finish (only applies if table-top power is selected)	UCO Undermount	
<b>M</b> Metal Trim		ECO Edgemount	
<b>T003</b> Top Finish	<b>Trim Type</b>	T1E Tabletop 1-Sided Lid	
<b>PM01</b> Trim Finish	N = No trim	T2C Tabletop 2-Sided Lid	
<b>MC01</b> Base Finish	M = Metal (available in Premium and Powder Coat finishes)	<b>Must select Wire Management Column and Finish:</b>	
<b>GM2</b> Grommet Opt.	L = Leather	Powder coated	
<b>MC01</b> Grommet Finish		Premium (Polished Chrome, Satin Nickel or Oil Rubbed Bronze)	
<b>UCO</b> Undermount			

# Rectangular Conference Tables

**42" Deep Tops**  
**2-Layer, Veneer Tops**

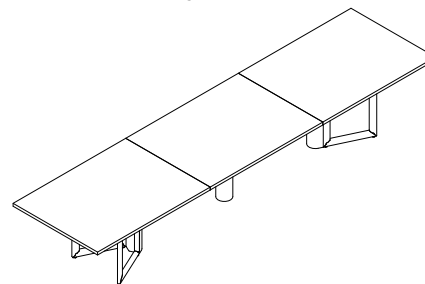

D	W	Pattern No.	T1__ Top	T2__ Top	T__ Lower Layer	HG__ Lower Layer	PM__ Edge Upcharge	AU__ Edge Upcharge	PM__ Base Upcharge
42"	84"	<b>08VOFR4284VF2</b>	\$19,385	\$20,084	\$515	\$564	\$586	\$2,051	\$2,416
42"	96"	<b>08VOFR4296VF2</b>	20,470	21,268	567	625	635	2,236	2,416
42"	108"	<b>08VOFR42108VF2</b>	21,555	22,452	628	690	682	2,425	2,416
42"	120"	<b>08VOFR42120VF2</b>	22,640	23,636	716	788	729	2,610	2,416
42"	132"	<b>08VOFR42132VF2</b>	23,725	24,822	765	841	810	2,797	2,416
42"	144"	<b>08VOFR42144VF2</b>	24,810	26,006	813	893	856	2,982	2,416
42"	156"	<b>08VOFR42156VF2</b>	25,895	27,192	819	900	905	3,170	2,416
42"	168"	<b>08VOFR42168VF2</b>	28,692	30,089	902	994	949	3,355	4,083
42"	180"	<b>08VOFR42180VF2</b>	29,405	30,885	997	1,097	998	3,542	4,083
42"	192"	<b>08VOFR42192VF2</b>	30,118	31,712	1,020	1,123	1,046	3,728	4,083
42"	204"	<b>08VOFR42204VF2</b>	30,830	32,525	1,074	1,183	1,093	3,915	4,083
42"	216"	<b>08VOFR42216VF2</b>	31,541	33,337	1,136	1,248	1,110	4,101	4,083
42"	228"	<b>08VOFR42228VF2</b>	32,253	34,150	1,194	1,314	1,190	4,320	4,083
42"	240"	<b>08VOFR42240VF2</b>	32,968	34,960	1,285	1,413	1,236	4,475	4,083

Order Code	Specification Information	Refer To Accessories Section	Pricing Tiers
Example: <b>08VOFR4284VF2M-T003-PM01-MC01-GM2-MC01-UCO</b>	To order please specify pattern number including:	Please refer to Accessories section, <a href="#">page 213</a> for power details.	Please refer to Materials and Finish <a href="#">page 9</a> for specification details.
<b>08</b> Highline Collection	1. Top finish	<b>Grommet options available in these finishes:</b>	T1 and T2 pricing includes powder coated base finish.
<b>VOF</b> Vector Base	2. Trim Finish (only applies if trim type is metal or leather)	Powder coated	There is an upcharge for plated base finishes as highlighted above.
<b>R</b> Rectangular	3. Base finish	Premium (Polished Chrome, Satin Nickel or Oil Rubbed Bronze)	For additional stone options and pricing please contact your sales representative."
<b>42</b> Depth	4. Grommet option	<b>Power Box Options</b>	
<b>84</b> Width	5. Grommet finish (only applies if grommets are selected)	<b>Code: Description:</b>	
<b>V</b> Veneer	6. Power box option	NP No Power	
<b>F2</b> 2 Layer-Flat w/ Trim	7. Table-top power finish (only applies if table-top power is selected)	UCO Undermount	
<b>M</b> Metal Trim		ECO Edgemount	
<b>T003</b> Top Finish	<b>Trim Type</b>	T1E Tabletop 1-Sided Lid	
<b>PM01</b> Trim Finish	N = No trim	T2C Tabletop 2-Sided Lid	
<b>MC01</b> Base Finish	M = Metal (available in Premium and Powder Coat finishes)	<b>Must select Wire Management Column and Finish:</b>	
<b>GM2</b> Grommet Opt.	L = Leather	Powder coated	
<b>MC01</b> Grommet Finish		Premium (Polished Chrome, Satin Nickel or Oil Rubbed Bronze)	
<b>UCO</b> Undermount			

# Rectangular Conference Tables

**42" Deep Tops**  
**Slab Top, Veneer Tops**

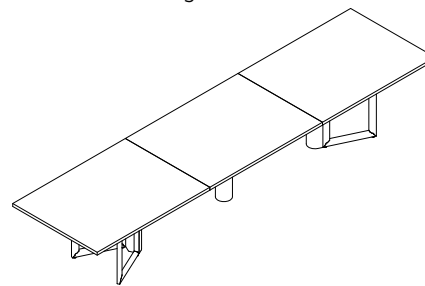

D	W	Pattern No.	T1__ Top	T2__ Top	MC__ Edge Upcharge	PM__ Edge Upcharge	AU__ Edge Upcharge	PM__ Base Upcharge
42"	84"	<b>08VOFR4284VSF</b>	\$16,899	\$17,598	\$2,487	\$3,072	\$4,538	\$2,416
42"	96"	<b>08VOFR4296VSF</b>	17,801	18,599	2,668	3,303	4,904	2,416
42"	108"	<b>08VOFR42108VSF</b>	18,703	19,600	2,852	3,534	5,277	2,416
42"	120"	<b>08VOFR42120VSF</b>	19,603	20,601	3,037	3,766	5,647	2,416
42"	132"	<b>08VOFR42132VSF</b>	20,506	21,603	3,219	4,028	6,015	2,416
42"	144"	<b>08VOFR42144VSF</b>	21,408	22,605	3,403	4,259	6,384	2,416
42"	156"	<b>08VOFR42156VSF</b>	22,311	23,608	3,583	4,488	6,753	2,416
42"	168"	<b>08VOFR42168VSF</b>	24,760	26,156	3,932	4,881	7,287	4,083
42"	180"	<b>08VOFR42180VSF</b>	25,475	26,955	3,930	4,928	7,472	4,083
42"	192"	<b>08VOFR42192VSF</b>	26,189	27,785	3,929	4,974	7,657	4,083
42"	204"	<b>08VOFR42204VSF</b>	26,905	28,600	3,925	5,019	7,841	4,083
42"	216"	<b>08VOFR42216VSF</b>	27,619	29,413	3,922	5,032	8,023	4,083
42"	228"	<b>08VOFR42228VSF</b>	28,334	30,229	3,920	5,109	8,239	4,083
42"	240"	<b>08VOFR42240VSF</b>	29,051	31,045	3,916	5,153	8,391	4,083

Order Code	Specification Information	Refer To Accessories Section	Pricing Tiers
Example: <b>08VOFR4284VSFM-T003-PM01-MC01-GM2-MC01-UC0</b>	To order please specify pattern number including:	Please refer to Accessories section, <a href="#">page 213</a> for power details.	Please refer to Materials and Finish <a href="#">page 9</a> for specification details.
<b>08</b> Highline Collection	1. Top finish	<b>Grommet options available in these finishes:</b>	T1 and T2 pricing includes powder coated base finish.
<b>VOF</b> Vector Base	2. Trim Finish (only applies if trim type is metal or leather)	Powder coated	There is an upcharge for plated base finishes as highlighted above.
<b>R</b> Rectangular	3. Base finish	Premium (Polished Chrome, Satin Nickel or Oil Rubbed Bronze)	For additional stone options and pricing please contact your sales representative."
<b>42</b> Depth	4. Grommet option	<b>Power Box Options</b>	
<b>84</b> Width	5. Grommet finish (only applies if grommets are selected)	<b>Code: Description:</b>	
<b>VS</b> Veneer	6. Power box option	NP No Power	
<b>SF</b> Slab	7. Table-top power finish (only applies if table-top power is selected)	UCO Undermount	
<b>M</b> Metal Trim		ECO Edgemount	
<b>T003</b> Top Finish	<b>Trim Type</b>	T1E Tabletop 1-Sided Lid	
<b>PM01</b> Trim Finish	N = No trim	T2C Tabletop 2-Sided Lid	
<b>MC01</b> Base Finish	M = Metal (available in Premium and Powder Coat finishes)	<b>Must select Wire Management Column and Finish:</b>	
<b>GM2</b> Grommet Opt.	L = Leather	Powder coated	
<b>MC01</b> Grommet Finish		Premium (Polished Chrome, Satin Nickel or Oil Rubbed Bronze)	
<b>UC0</b> Undermount			



# Rectangular Conference Tables

**42" Deep Tops**  
**1-Layer, Glass Tops**

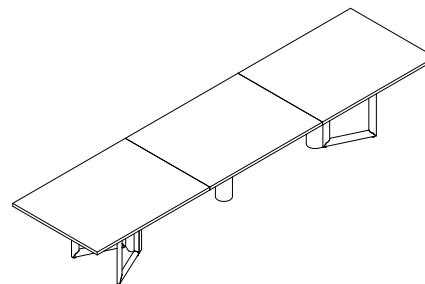

D	W	Pattern No.	GC__ Top	GE__ Top	PM__ Edge Upcharge	AU__ Edge Upcharge	PM__ Base Upcharge
42"	84"	<b>08VOFR4284GF1</b>	\$21,425	\$22,058	\$586	\$2,051	\$2,416
42"	96"	<b>08VOFR4296GF1</b>	22,932	23,656	635	2,236	2,416
42"	108"	<b>08VOFR42108GF1</b>	24,440	25,252	682	2,425	2,416
42"	120"	<b>08VOFR42120GF1</b>	25,946	26,849	729	2,610	2,416
42"	132"	<b>08VOFR42132GF1</b>	27,453	28,448	810	2,797	2,416
42"	144"	<b>08VOFR42144GF1</b>	28,960	30,045	856	2,982	2,416
42"	156"	<b>08VOFR42156GF1</b>	30,467	31,642	905	3,170	2,416
42"	168"	<b>08VOFR42168GF1</b>	33,291	34,556	949	3,355	4,083
42"	180"	<b>08VOFR42180GF1</b>	34,450	35,806	998	3,542	4,083
42"	192"	<b>08VOFR42192GF1</b>	35,608	37,054	1,046	3,728	4,083
42"	204"	<b>08VOFR42204GF1</b>	36,768	38,304	1,093	3,915	4,083
42"	216"	<b>08VOFR42216GF1</b>	37,925	39,552	1,110	4,101	4,083
42"	228"	<b>08VOFR42228GF1</b>	39,085	40,802	1,190	4,320	4,083
42"	240"	<b>08VOFR42240GF1</b>	40,244	42,050	1,236	4,475	4,083

Order Code	Specification Information	Refer To Accessories Section	Pricing Tiers
Example: <b>08VOFR4284GF1M-GE01-PM01-MC01-GM2-MC01-UC0</b>	To order please specify pattern number including:	Please refer to Accessories section, <a href="#">page 213</a> for power details.	Please refer to Materials and Finish <a href="#">page 9</a> for specification details.
<b>08</b> Highline Collection	1. Top finish	<b>Grommet options available in these finishes:</b>	T1 and T2 pricing includes powder coated base finish.
<b>VOF</b> Vector Base	2. Trim Finish (only applies if trim type is metal or leather)	Powder coated	There is an upcharge for plated base finishes as highlighted above.
<b>R</b> Rectangular	3. Base finish	Premium (Polished Chrome, Satin Nickel or Oil Rubbed Bronze)	For additional stone options and pricing please contact your sales representative."
<b>42</b> Depth	4. Grommet option	<b>Power Box Options</b>	
<b>84</b> Width	5. Grommet finish (only applies if grommets are selected)	<b>Code: Description:</b>	
<b>G</b> Glass	6. Power box option	NP No Power	
<b>F1</b> 1 Layer-Flat w/ Trim	7. Table-top power finish (only applies if table-top power is selected)	UCO Undermount	
<b>M</b> Metal Trim		ECO Edgemount	
<b>GE01</b> Top Finish	<b>Trim Type</b>	T1E Tabletop 1-Sided Lid	
<b>PM01</b> Trim Finish	N = No trim	T2C Tabletop 2-Sided Lid	
<b>MC01</b> Base Finish	M = Metal (available in Premium and Powder Coat finishes)	<b>Must select Wire Management Column and Finish:</b>	
<b>GM2</b> Grommet Opt.	L = Leather	Powder coated	
<b>MC01</b> Grommet Finish		Premium (Polished Chrome, Satin Nickel or Oil Rubbed Bronze)	
<b>UC0</b> Undermount			



# Rectangular Conference Tables

**42" Deep Tops**  
**2-Layer, Glass Tops**

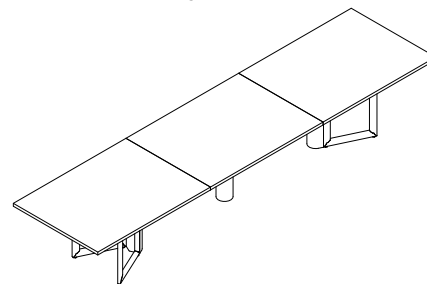

D	W	Pattern No.	GC__ Top	GE__ Top	T__ Lower Layer	HG__ Lower Layer	PM__ Edge Upcharge	AU__ Edge Upcharge	PM__ Base Upcharge
42"	84"	<b>08VOFR4284GF2</b>	\$23,336	\$23,967	\$515	\$564	\$586	\$2,051	\$2,416
42"	96"	<b>08VOFR4296GF2</b>	24,913	25,638	567	625	635	2,236	2,416
42"	108"	<b>08VOFR42108GF2</b>	26,492	27,306	628	690	682	2,425	2,416
42"	120"	<b>08VOFR42120GF2</b>	28,069	28,973	716	788	729	2,610	2,416
42"	132"	<b>08VOFR42132GF2</b>	29,648	30,643	765	841	810	2,797	2,416
42"	144"	<b>08VOFR42144GF2</b>	31,225	32,310	813	893	856	2,982	2,416
42"	156"	<b>08VOFR42156GF2</b>	32,805	33,979	819	900	905	3,170	2,416
42"	168"	<b>08VOFR42168GF2</b>	36,168	37,432	902	994	949	3,355	4,083
42"	180"	<b>08VOFR42180GF2</b>	37,357	38,713	997	1,097	998	3,542	4,083
42"	192"	<b>08VOFR42192GF2</b>	38,547	39,992	1,020	1,123	1,046	3,728	4,083
42"	204"	<b>08VOFR42204GF2</b>	39,736	41,274	1,074	1,183	1,093	3,915	4,083
42"	216"	<b>08VOFR42216GF2</b>	40,926	42,552	1,136	1,248	1,110	4,101	4,083
42"	228"	<b>08VOFR42228GF2</b>	42,115	43,833	1,194	1,314	1,190	4,320	4,083
42"	240"	<b>08VOFR42240GF2</b>	43,306	45,113	1,285	1,413	1,236	4,475	4,083

Order Code	Specification Information	Refer To Accessories Section	Pricing Tiers
Example: <b>08VOFR4284GF2M-GE01-PM01-MC01-GM2-MC01-UCO</b>	To order please specify pattern number including:	Please refer to Accessories section, <a href="#">page 213</a> for power details.	Please refer to Materials and Finish <a href="#">page 9</a> for specification details.
<b>08</b> Highline Collection	1. Top finish	<b>Grommet options available in these finishes:</b>	T1 and T2 pricing includes powder coated base finish.
<b>VOF</b> Vector Base	2. Trim Finish (only applies if trim type is metal or leather)	Powder coated	There is an upcharge for plated base finishes as highlighted above.
<b>R</b> Rectangular	3. Base finish	Premium (Polished Chrome, Satin Nickel or Oil Rubbed Bronze)	For additional stone options and pricing please contact your sales representative."
<b>42</b> Depth	4. Grommet option	<b>Power Box Options</b>	
<b>84</b> Width	5. Grommet finish (only applies if grommets are selected)	<b>Code: Description:</b>	
<b>G</b> Glass	6. Power box option	NP No Power	
<b>F2</b> 2 Layer-Flat w/ Trim	7. Table-top power finish (only applies if table-top power is selected)	UCO Undermount	
<b>M</b> Metal Trim		ECO Edgemount	
<b>GE01</b> Top Finish	<b>Trim Type</b>	T1E Tabletop 1-Sided Lid	
<b>PM01</b> Trim Finish	N = No trim	T2C Tabletop 2-Sided Lid	
<b>MC01</b> Base Finish	M = Metal (available in Premium and Powder Coat finishes)	<b>Must select Wire Management Column and Finish:</b>	
<b>GM2</b> Grommet Opt.	L = Leather	Powder coated	
<b>MC01</b> Grommet Finish		Premium (Polished Chrome, Satin Nickel or Oil Rubbed Bronze)	
<b>UCO</b> Undermount			

# Rectangular Conference Tables

**42" Deep Tops**  
**1-Layer, Corian Tops**

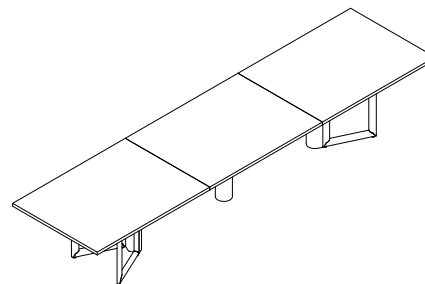

D	W	Pattern No.	CS01 Top	MC__ Edge Upcharge	PM__ Edge Upcharge	AU__ Edge Upcharge	PM__ Base Upcharge
42"	84"	<b>08VOFR4284CF1</b>	\$19,467	\$2,485	\$3,071	\$4,537	\$2,416
42"	96"	<b>08VOFR4296CF1</b>	20,928	2,669	3,304	4,906	2,416
42"	108"	<b>08VOFR42108CF1</b>	22,369	2,852	3,534	5,277	2,416
42"	120"	<b>08VOFR42120CF1</b>	23,852	3,036	3,765	5,645	2,416
42"	132"	<b>08VOFR42132CF1</b>	25,315	3,219	4,028	6,015	2,416
42"	144"	<b>08VOFR42144CF1</b>	26,777	3,401	4,258	6,383	2,416
42"	156"	<b>08VOFR42156CF1</b>	28,240	3,584	4,489	6,754	2,416
42"	168"	<b>08VOFR42168CF1</b>	30,800	3,933	4,882	7,288	4,083
42"	180"	<b>08VOFR42180CF1</b>	32,115	3,930	4,928	7,472	4,083
42"	192"	<b>08VOFR42192CF1</b>	33,427	3,928	4,973	7,656	4,083
42"	204"	<b>08VOFR42204CF1</b>	34,742	3,925	5,019	7,841	4,083
42"	216"	<b>08VOFR42216CF1</b>	36,056	3,922	5,032	8,023	4,083
42"	228"	<b>08VOFR42228CF1</b>	37,369	3,920	5,109	8,239	4,083
42"	240"	<b>08VOFR42240CF1</b>	38,684	3,915	5,151	8,390	4,083

Order Code	Specification Information	Refer To Accessories Section	Pricing Tiers
Example: <b>08VOFR4284CF1M-CS01-PM01-MC01-GM2-MC01-UCO</b>	To order please specify pattern number including:	Please refer to Accessories section, <a href="#">page 213</a> for power details.	Please refer to Materials and Finish <a href="#">page 9</a> for specification details.
<b>08</b> Highline Collection	1. Top finish	<b>Grommet options available in these finishes:</b>	T1 and T2 pricing includes powder coated base finish.
<b>VOF</b> Vector Base	2. Trim Finish (only applies if trim type is metal or leather)	Powder coated	There is an upcharge for plated base finishes as highlighted above.
<b>R</b> Rectangular	3. Base finish	Premium (Polished Chrome, Satin Nickel or Oil Rubbed Bronze)	For additional stone options and pricing please contact your sales representative."
<b>42</b> Depth	4. Grommet option	<b>Power Box Options</b>	
<b>84</b> Width	5. Grommet finish (only applies if grommets are selected)	<b>Code: Description:</b>	
<b>C</b> Corian	6. Power box option	NP No Power	
<b>F1</b> 1 Layer-Flat w/ Trim	7. Table-top power finish (only applies if table-top power is selected)	UCO Undermount	
<b>M</b> Metal Trim		ECO Edgemount	
<b>CS01</b> Top Finish	<b>Trim Type</b>	T1E Tabletop 1-Sided Lid	
<b>PM01</b> Trim Finish	N = No trim	T2C Tabletop 2-Sided Lid	
<b>MC01</b> Base Finish	M = Metal (available in Premium and Powder Coat finishes)	<b>Must select Wire Management Column and Finish:</b>	
<b>GM2</b> Grommet Opt.	L = Leather	Powder coated	
<b>MC01</b> Grommet Finish		Premium (Polished Chrome, Satin Nickel or Oil Rubbed Bronze)	
<b>UCO</b> Undermount			

# Rectangular Conference Tables

**42" Deep Tops**  
**2-Layer, Corian Tops**

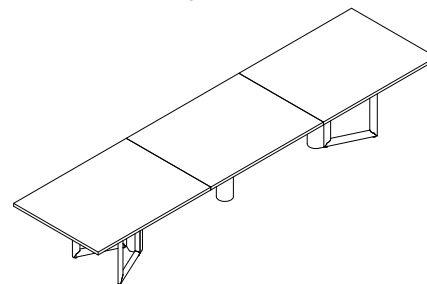

D	W	Pattern No.	CS01 Top	T___ Lower Layer	HG___ Lower Layer	PM___ Edge Upcharge	AU___ Edge Upcharge	PM___ Base Upcharge
42"	84"	<b>08VOFR4284CF2</b>	\$23,786	\$515	\$564	\$586	\$2,051	\$2,416
42"	96"	<b>08VOFR4296CF2</b>	25,498	567	625	635	2,236	2,416
42"	108"	<b>08VOFR42108CF2</b>	27,190	628	690	682	2,425	2,416
42"	120"	<b>08VOFR42120CF2</b>	28,926	716	788	729	2,610	2,416
42"	132"	<b>08VOFR42132CF2</b>	30,640	765	841	810	2,797	2,416
42"	144"	<b>08VOFR42144CF2</b>	32,353	813	893	856	2,982	2,416
42"	156"	<b>08VOFR42156CF2</b>	34,066	819	900	905	3,170	2,416
42"	168"	<b>08VOFR42168CF2</b>	37,493	902	994	949	3,355	4,083
42"	180"	<b>08VOFR42180CF2</b>	38,835	997	1,097	998	3,542	4,083
42"	192"	<b>08VOFR42192CF2</b>	40,175	1,020	1,123	1,046	3,728	4,083
42"	204"	<b>08VOFR42204CF2</b>	41,516	1,074	1,183	1,093	3,915	4,083
42"	216"	<b>08VOFR42216CF2</b>	42,856	1,136	1,248	1,110	4,101	4,083
42"	228"	<b>08VOFR42228CF2</b>	44,197	1,194	1,314	1,190	4,320	4,083
42"	240"	<b>08VOFR42240CF2</b>	45,538	1,285	1,413	1,236	4,475	4,083

Order Code	Specification Information	Refer To Accessories Section	Pricing Tiers
Example: <b>08VOFR4284CF2M-CS01-PM01-MC01-GM2-MC01-UCO</b>	To order please specify pattern number including:	Please refer to Accessories section, <a href="#">page 213</a> for power details.	Please refer to Materials and Finish <a href="#">page 9</a> for specification details.
<b>08</b> Highline Collection	1. Top finish	<b>Grommet options available in these finishes:</b>	T1 and T2 pricing includes powder coated base finish.
<b>VOF</b> Vector Base	2. Trim Finish (only applies if trim type is metal or leather)	Powder coated	There is an upcharge for plated base finishes as highlighted above.
<b>R</b> Rectangular	3. Base finish	Premium (Polished Chrome, Satin Nickel or Oil Rubbed Bronze)	For additional stone options and pricing please contact your sales representative."
<b>42</b> Depth	4. Grommet option	<b>Power Box Options</b>	
<b>84</b> Width	5. Grommet finish (only applies if grommets are selected)	<b>Code: Description:</b>	
<b>C</b> Corian	6. Power box option	NP No Power	
<b>F2</b> 2 Layer-Flat w/ Trim	7. Table-top power finish (only applies if table-top power is selected)	UCO Undermount	
<b>M</b> Metal Trim		ECO Edgemount	
<b>CS01</b> Top Finish	<b>Trim Type</b>	T1E Tabletop 1-Sided Lid	
<b>PM01</b> Trim Finish	N = No trim	T2C Tabletop 2-Sided Lid	
<b>MC01</b> Base Finish	M = Metal (available in Premium and Powder Coat finishes)	<b>Must select Wire Management Column and Finish:</b>	
<b>GM2</b> Grommet Opt.	L = Leather	Powder coated	
<b>MC01</b> Grommet Finish		Premium (Polished Chrome, Satin Nickel or Oil Rubbed Bronze)	
<b>UCO</b> Undermount			

# Rectangular Conference Tables

**48" Deep Tops**  
**1-Layer, Veneer Tops**

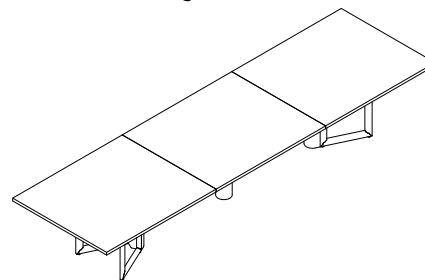

D	W	Pattern No.	T1__ Top	T2__ Top	MC__ Edge Upcharge	PM__ Edge Upcharge	AU__ Edge Upcharge	PM__ Base Upcharge
48"	84"	<b>08VOFR4884VF1</b>	\$15,728	\$16,525	\$2,539	\$3,209	\$4,882	\$2,416
48"	96"	<b>08VOFR4896VF1</b>	16,663	17,573	2,729	3,453	5,285	2,416
48"	108"	<b>08VOFR48108VF1</b>	17,598	18,623	2,917	3,696	5,688	2,416
48"	120"	<b>08VOFR48120VF1</b>	18,532	19,672	3,108	3,942	6,090	2,416
48"	132"	<b>08VOFR48132VF1</b>	19,468	20,722	3,296	4,220	6,492	2,416
48"	144"	<b>08VOFR48144VF1</b>	20,403	21,771	3,486	4,465	6,895	2,416
48"	156"	<b>08VOFR48156VF1</b>	21,339	22,820	3,675	4,708	7,297	2,416
48"	168"	<b>08VOFR48168VF1</b>	23,394	24,990	3,969	5,055	7,803	4,083
48"	180"	<b>08VOFR48180VF1</b>	24,182	25,855	3,963	5,104	8,010	4,083
48"	192"	<b>08VOFR48192VF1</b>	24,970	26,793	3,960	5,155	8,221	4,083
48"	204"	<b>08VOFR48204VF1</b>	25,757	27,694	3,956	5,206	8,431	4,083
48"	216"	<b>08VOFR48216VF1</b>	26,546	28,596	3,952	5,220	8,638	4,083
48"	228"	<b>08VOFR48228VF1</b>	27,332	29,498	3,950	5,309	8,886	4,083
48"	240"	<b>08VOFR48240VF1</b>	28,116	30,396	3,951	5,364	9,063	4,083

Order Code	Specification Information	Refer To Accessories Section	Pricing Tiers
Example: <b>08VOFR4884VF1M-T003-PM01-MC01-GM2-MC01-UCO</b>	To order please specify pattern number including:	Please refer to Accessories section, <a href="#">page 213</a> for power details.	Please refer to Materials and Finish <a href="#">page 9</a> for specification details.
<b>08</b> Highline Collection	1. Top finish	<b>Grommet options available in these finishes:</b>	T1 and T2 pricing includes powder coated base finish.
<b>VOF</b> Vector Base	2. Trim Finish (only applies if trim type is metal or leather)	Powder coated	There is an upcharge for plated base finishes as highlighted above.
<b>R</b> Rectangular	3. Base finish	Premium (Polished Chrome, Satin Nickel or Oil Rubbed Bronze)	For additional stone options and pricing please contact your sales representative."
<b>48</b> Depth	4. Grommet option	<b>Power Box Options</b>	
<b>84</b> Width	5. Grommet finish (only applies if grommets are selected)	<b>Code: Description:</b>	
<b>V</b> Veneer	6. Power box option	NP No Power	
<b>F1</b> 1 Layer-Flat w/ Trim	7. Table-top power finish (only applies if table-top power is selected)	UCO Undermount	
<b>M</b> Metal Trim		ECO Edgemount	
<b>T003</b> Top Finish	<b>Trim Type</b>	TIE Tabletop 1-Sided Lid	
<b>PM01</b> Trim Finish	N = No trim	T2C Tabletop 2-Sided Lid	
<b>MC01</b> Base Finish	M = Metal (available in Premium and Powder Coat finishes)	<b>Must select Wire Management Column and Finish:</b>	
<b>GM2</b> Grommet Opt.	L = Leather	Powder coated	
<b>MC01</b> Grommet Finish		Premium (Polished Chrome, Satin Nickel or Oil Rubbed Bronze)	
<b>UCO</b> Undermount			

# Rectangular Conference Tables

**48" Deep Tops**  
**2-Layer, Veneer Tops**

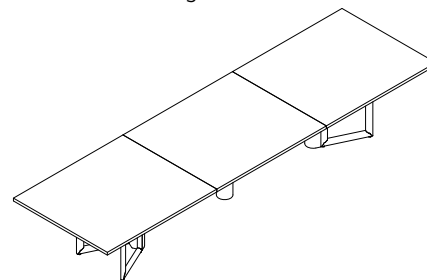

D	W	Pattern No.	T1__ Top	T2__ Top	T__ Lower Layer	HG__ Lower Layer	PM__ Edge Upcharge	AU__ Edge Upcharge	PM__ Base Upcharge
48"	84"	<b>08VOFR4884VF2</b>	\$20,612	\$21,410	\$588	\$644	\$670	\$2,344	\$2,416
48"	96"	<b>08VOFR4896VF2</b>	21,590	22,501	648	714	724	2,556	2,416
48"	108"	<b>08VOFR48108VF2</b>	22,567	23,592	718	789	779	2,770	2,416
48"	120"	<b>08VOFR48120VF2</b>	23,543	24,683	819	900	834	2,982	2,416
48"	132"	<b>08VOFR48132VF2</b>	24,521	25,775	874	961	924	3,195	2,416
48"	144"	<b>08VOFR48144VF2</b>	25,498	26,866	929	1,020	979	3,409	2,416
48"	156"	<b>08VOFR48156VF2</b>	26,476	27,958	936	1,030	1,033	3,622	2,416
48"	168"	<b>08VOFR48168VF2</b>	29,802	31,398	1,031	1,135	1,087	3,835	4,083
48"	180"	<b>08VOFR48180VF2</b>	30,596	32,269	1,140	1,254	1,141	4,047	4,083
48"	192"	<b>08VOFR48192VF2</b>	31,390	33,214	1,166	1,285	1,195	4,261	4,083
48"	204"	<b>08VOFR48204VF2</b>	32,184	34,121	1,229	1,351	1,249	4,475	4,083
48"	216"	<b>08VOFR48216VF2</b>	32,978	35,029	1,298	1,428	1,268	4,686	4,083
48"	228"	<b>08VOFR48228VF2</b>	33,772	35,937	1,365	1,502	1,359	4,937	4,083
48"	240"	<b>08VOFR48240VF2</b>	34,566	36,844	1,468	1,615	1,413	5,113	4,083

Order Code	Specification Information	Refer To Accessories Section	Pricing Tiers
Example: <b>08VOFR4884VF2M-T003-PM01-MC01-GM2-MC01-UCO</b>	To order please specify pattern number including:	Please refer to Accessories section, <a href="#">page 213</a> for power details.	Please refer to Materials and Finish <a href="#">page 9</a> for specification details.
<b>08</b> Highline Collection	1. Top finish	<b>Grommet options available in these finishes:</b>	T1 and T2 pricing includes powder coated base finish.
<b>VOF</b> Vector Base	2. Trim Finish (only applies if trim type is metal or leather)	Powder coated	There is an upcharge for plated base finishes as highlighted above.
<b>R</b> Rectangular	3. Base finish	Premium (Polished Chrome, Satin Nickel or Oil Rubbed Bronze)	For additional stone options and pricing please contact your sales representative."
<b>48</b> Depth	4. Grommet option	<b>Power Box Options</b>	
<b>84</b> Width	5. Grommet finish (only applies if grommets are selected)	<b>Code: Description:</b>	
<b>V</b> Veneer	6. Power box option	NP No Power	
<b>F2</b> 2 Layer-Flat w/ Trim	7. Table-top power finish (only applies if table-top power is selected)	UCO Undermount	
<b>M</b> Metal Trim		ECO Edgemount	
<b>T003</b> Top Finish	<b>Trim Type</b>	T1E Tabletop 1-Sided Lid	
<b>PM01</b> Trim Finish	N = No trim	T2C Tabletop 2-Sided Lid	
<b>MC01</b> Base Finish	M = Metal (available in Premium and Powder Coat finishes)	<b>Must select Wire Management Column and Finish:</b>	
<b>GM2</b> Grommet Opt.	L = Leather	Powder coated	
<b>MC01</b> Grommet Finish		Premium (Polished Chrome, Satin Nickel or Oil Rubbed Bronze)	
<b>UCO</b> Undermount			

# Rectangular Conference Tables

## 48" Deep Tops Slab Top Veneer Tops

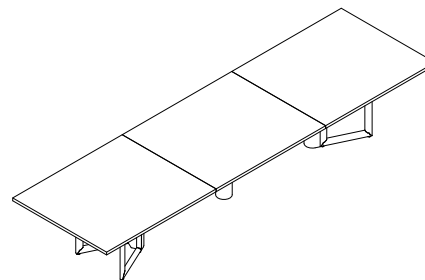

D	W	Pattern No.	T1__ Top	T2__ Top	MC__ Edge Upcharge	PM__ Edge Upcharge	AU__ Edge Upcharge	PM__ Base Upcharge
48"	84"	<b>08VOFR4884VSF</b>	\$18,074	\$18,871	\$2,539	\$3,209	\$4,882	\$2,416
48"	96"	<b>08VOFR4896VSF</b>	18,860	19,773	2,730	3,455	5,287	2,416
48"	108"	<b>08VOFR48108VSF</b>	19,649	20,674	2,919	3,697	5,689	2,416
48"	120"	<b>08VOFR48120VSF</b>	20,436	21,576	3,107	3,941	6,088	2,416
48"	132"	<b>08VOFR48132VSF</b>	21,225	22,478	3,296	4,220	6,492	2,416
48"	144"	<b>08VOFR48144VSF</b>	22,012	23,379	3,486	4,465	6,895	2,416
48"	156"	<b>08VOFR48156VSF</b>	22,800	24,282	3,676	4,710	7,298	2,416
48"	168"	<b>08VOFR48168VSF</b>	25,836	27,431	3,966	5,053	7,801	4,083
48"	180"	<b>08VOFR48180VSF</b>	26,633	28,306	3,963	5,104	8,010	4,083
48"	192"	<b>08VOFR48192VSF</b>	27,431	29,254	3,960	5,155	8,221	4,083
48"	204"	<b>08VOFR48204VSF</b>	28,229	30,165	3,954	5,204	8,429	4,083
48"	216"	<b>08VOFR48216VSF</b>	29,026	31,077	3,952	5,220	8,638	4,083
48"	228"	<b>08VOFR48228VSF</b>	29,823	31,989	3,949	5,308	8,885	4,083
48"	240"	<b>08VOFR48240VSF</b>	30,616	32,896	3,950	5,363	9,062	4,083

Order Code	Specification Information	Refer To Accessories Section	Pricing Tiers
Example: <b>08VOFR4884VSFM-T003-PM01-MC01-GM2-MC01-UCO</b>	To order please specify pattern number including:	Please refer to Accessories section, <b>page 213</b> for power details.	Please refer to Materials and Finish <b>page 9</b> for specification details.
<b>08</b> Highline Collection	1. Top finish	<b>Grommet options available in these finishes:</b>	T1 and T2 pricing includes powder coated base finish.
<b>VOF</b> Vector Base	2. Trim Finish (only applies if trim type is metal or leather)	Powder coated	There is an upcharge for plated base finishes as highlighted above.
<b>R</b> Rectangular	3. Base finish	Premium (Polished Chrome, Satin Nickel or Oil Rubbed Bronze)	For additional stone options and pricing please contact your sales representative."
<b>48</b> Depth	4. Grommet option	<b>Power Box Options</b>	
<b>84</b> Width	5. Grommet finish (only applies if grommets are selected)	<b>Code: Description:</b>	
<b>V</b> Veneer	6. Power box option	NP No Power	
<b>SF</b> Slab	7. Table-top power finish (only applies if table-top power is selected)	UCO Undermount	
<b>M</b> Metal Trim		ECO Edgemount	
<b>T003</b> Top Finish	<b>Trim Type</b>	T1E Tabletop 1-Sided Lid	
<b>PM01</b> Trim Finish	N = No trim	T2C Tabletop 2-Sided Lid	
<b>MC01</b> Base Finish	M = Metal (available in Premium and Powder Coat finishes)	<b>Must select Wire Management Column and Finish:</b>	
<b>GM2</b> Grommet Opt.	L = Leather	Powder coated	
<b>MC01</b> Grommet Finish		Premium (Polished Chrome, Satin Nickel or Oil Rubbed Bronze)	
<b>UCO</b> Undermount			





# Rectangular Conference Tables

**48" Deep Tops**  
**1-Layer, Glass Tops**

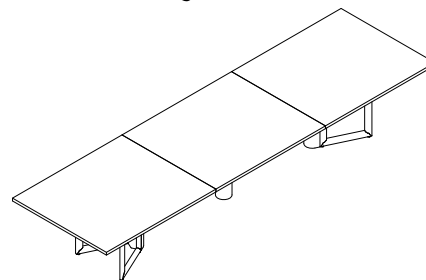

D	W	Pattern No.	GC__ Top	GE__ Top	PM__ Edge Upcharge	AU__ Edge Upcharge	PM__ Base Upcharge
48"	84"	<b>08VOFR4884GF1</b>	\$22,617	\$23,339	\$670	\$2,344	\$2,416
48"	96"	<b>08VOFR4896GF1</b>	24,300	25,127	724	2,556	2,416
48"	108"	<b>08VOFR48108GF1</b>	25,983	26,912	779	2,770	2,416
48"	120"	<b>08VOFR48120GF1</b>	27,667	28,700	834	2,982	2,416
48"	132"	<b>08VOFR48132GF1</b>	29,350	30,487	924	3,195	2,416
48"	144"	<b>08VOFR48144GF1</b>	31,034	32,273	979	3,409	2,416
48"	156"	<b>08VOFR48156GF1</b>	32,716	34,059	1,033	3,622	2,416
48"	168"	<b>08VOFR48168GF1</b>	35,675	37,120	1,087	3,835	4,083
48"	180"	<b>08VOFR48180GF1</b>	37,003	38,551	1,141	4,047	4,083
48"	192"	<b>08VOFR48192GF1</b>	38,332	39,983	1,195	4,261	4,083
48"	204"	<b>08VOFR48204GF1</b>	39,659	41,414	1,249	4,475	4,083
48"	216"	<b>08VOFR48216GF1</b>	40,988	42,848	1,268	4,686	4,083
48"	228"	<b>08VOFR48228GF1</b>	42,316	44,279	1,359	4,937	4,083
48"	240"	<b>08VOFR48240GF1</b>	43,646	45,712	1,413	5,113	4,083

Order Code	Specification Information	Refer To Accessories Section	Pricing Tiers
Example: <b>08VOFR4884GF1M-GE01-PM01-MC01-GM2-MC01-UCO</b>	To order please specify pattern number including:	Please refer to Accessories section, <a href="#">page 213</a> for power details.	Please refer to Materials and Finish <a href="#">page 9</a> for specification details.
<b>08</b> Highline Collection	1. Top finish	<b>Grommet options available in these finishes:</b>	T1 and T2 pricing includes powder coated base finish.
<b>VOF</b> Vector Base	2. Trim Finish (only applies if trim type is metal or leather)	Powder coated	There is an upcharge for plated base finishes as highlighted above.
<b>R</b> Rectangular	3. Base finish	Premium (Polished Chrome, Satin Nickel or Oil Rubbed Bronze)	For additional stone options and pricing please contact your sales representative."
<b>48</b> Depth	4. Grommet option	<b>Power Box Options</b>	
<b>84</b> Width	5. Grommet finish (only applies if grommets are selected)	<b>Code: Description:</b>	
<b>G</b> Glass	6. Power box option	NP No Power	
<b>F1</b> 1 Layer-Flat w/ Trim	7. Table-top power finish (only applies if table-top power is selected)	UCO Undermount	
<b>M</b> Metal Trim		ECO Edgemount	
<b>GE01</b> Top Finish	<b>Trim Type</b>	T1E Tabletop 1-Sided Lid	
<b>PM01</b> Trim Finish	N = No trim	T2C Tabletop 2-Sided Lid	
<b>MC01</b> Base Finish	M = Metal (available in Premium and Powder Coat finishes)	<b>Must select Wire Management Column and Finish:</b>	
<b>GM2</b> Grommet Opt.	L = Leather	Powder coated	
<b>MC01</b> Grommet Finish		Premium (Polished Chrome, Satin Nickel or Oil Rubbed Bronze)	
<b>UCO</b> Undermount			



# Rectangular Conference Tables

**48" Deep Tops**  
**2-Layer, Glass Tops**

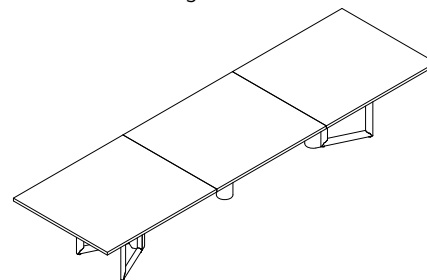

D	W	Pattern No.	GC__ Top	GE__ Top	T__ Lower Layer	HG__ Lower Layer	PM__ Edge Upcharge	AU__ Edge Upcharge	PM__ Base Upcharge
48"	84"	<b>08VOFR4884GF2</b>	\$25,062	\$25,785	\$588	\$644	\$670	\$2,344	\$2,416
48"	96"	<b>08VOFR4896GF2</b>	26,591	27,419	648	714	724	2,556	2,416
48"	108"	<b>08VOFR48108GF2</b>	28,121	29,050	718	789	779	2,770	2,416
48"	120"	<b>08VOFR48120GF2</b>	29,650	30,683	819	900	834	2,982	2,416
48"	132"	<b>08VOFR48132GF2</b>	31,181	32,316	874	961	924	3,195	2,416
48"	144"	<b>08VOFR48144GF2</b>	32,711	33,950	929	1,020	979	3,409	2,416
48"	156"	<b>08VOFR48156GF2</b>	34,240	35,583	936	1,030	1,033	3,622	2,416
48"	168"	<b>08VOFR48168GF2</b>	38,218	39,664	1,031	1,135	1,087	3,835	4,083
48"	180"	<b>08VOFR48180GF2</b>	39,557	41,106	1,140	1,254	1,141	4,047	4,083
48"	192"	<b>08VOFR48192GF2</b>	40,896	42,548	1,166	1,285	1,195	4,261	4,083
48"	204"	<b>08VOFR48204GF2</b>	42,235	43,991	1,229	1,351	1,249	4,475	4,083
48"	216"	<b>08VOFR48216GF2</b>	43,574	45,433	1,298	1,428	1,268	4,686	4,083
48"	228"	<b>08VOFR48228GF2</b>	44,912	46,875	1,365	1,502	1,359	4,937	4,083
48"	240"	<b>08VOFR48240GF2</b>	46,250	48,316	1,468	1,615	1,413	5,113	4,083

Order Code	Specification Information	Refer To Accessories Section	Pricing Tiers
Example: <b>08VOFR4884GF2M-GE01-PM01-MC01-GM2-MC01-UC0</b>	To order please specify pattern number including:	Please refer to Accessories section, <a href="#">page 213</a> for power details.	Please refer to Materials and Finish <a href="#">page 9</a> for specification details.
<b>08</b> Highline Collection	1. Top finish	<b>Grommet options available in these finishes:</b>	T1 and T2 pricing includes powder coated base finish.
<b>VOF</b> Vector Base	2. Trim Finish (only applies if trim type is metal or leather)	Powder coated	There is an upcharge for plated base finishes as highlighted above.
<b>R</b> Rectangular	3. Base finish	Premium (Polished Chrome, Satin Nickel or Oil Rubbed Bronze)	For additional stone options and pricing please contact your sales representative."
<b>48</b> Depth	4. Grommet option	<b>Power Box Options</b>	
<b>84</b> Width	5. Grommet finish (only applies if grommets are selected)	<b>Code: Description:</b>	
<b>G</b> Glass	6. Power box option	NP No Power	
<b>F2</b> 2 Layer-Flat w/ Trim	7. Table-top power finish (only applies if table-top power is selected)	UCO Undermount	
<b>M</b> Metal Trim		ECO Edgemount	
<b>GE01</b> Top Finish	<b>Trim Type</b>	T1E Tabletop 1-Sided Lid	
<b>PM01</b> Trim Finish	N = No trim	T2C Tabletop 2-Sided Lid	
<b>MC01</b> Base Finish	M = Metal (available in Premium and Powder Coat finishes)	<b>Must select Wire Management Column and Finish:</b>	
<b>GM2</b> Grommet Opt.	L = Leather	Powder coated	
<b>MC01</b> Grommet Finish		Premium (Polished Chrome, Satin Nickel or Oil Rubbed Bronze)	
<b>UC0</b> Undermount			

# Rectangular Conference Tables

**48" Deep Tops**  
**1-Layer, Corian Tops**

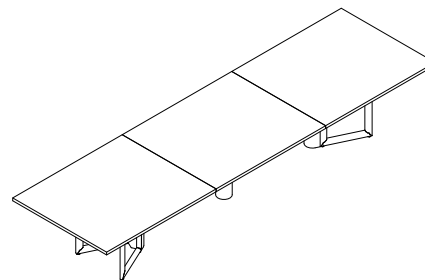

D	W	Pattern No.	CS01 Top	MC__ Edge Upchange	PM__ Edge Upchange	AU__ Edge Upchange	PM__ Base Upchange
48"	84"	<b>08VOFR4884CF1</b>	\$20,756	\$2,539	\$3,209	\$4,882	\$2,416
48"	96"	<b>08VOFR4896CF1</b>	22,410	2,728	3,452	5,284	2,416
48"	108"	<b>08VOFR48108CF1</b>	24,038	2,917	3,696	5,688	2,416
48"	120"	<b>08VOFR48120CF1</b>	25,716	3,108	3,942	6,090	2,416
48"	132"	<b>08VOFR48132CF1</b>	27,370	3,297	4,221	6,493	2,416
48"	144"	<b>08VOFR48144CF1</b>	29,024	3,486	4,465	6,895	2,416
48"	156"	<b>08VOFR48156CF1</b>	30,677	3,676	4,710	7,298	2,416
48"	168"	<b>08VOFR48168CF1</b>	33,451	3,969	5,055	7,803	4,083
48"	180"	<b>08VOFR48180CF1</b>	34,957	3,964	5,105	8,011	4,083
48"	192"	<b>08VOFR48192CF1</b>	36,463	3,960	5,155	8,221	4,083
48"	204"	<b>08VOFR48204CF1</b>	37,970	3,956	5,206	8,431	4,083
48"	216"	<b>08VOFR48216CF1</b>	39,476	3,952	5,220	8,638	4,083
48"	228"	<b>08VOFR48228CF1</b>	40,981	3,950	5,309	8,886	4,083
48"	240"	<b>08VOFR48240CF1</b>	42,484	3,951	5,364	9,063	4,083

Order Code	Specification Information	Refer To Accessories Section	Pricing Tiers
Example: <b>08VOFR4884CF1M-CS01-PM01-MC01-GM2-MC01-UC0</b>	To order please specify pattern number including:	Please refer to Accessories section, <a href="#">page 213</a> for power details.	Please refer to Materials and Finish <a href="#">page 9</a> for specification details.
<b>08</b> Highline Collection	1. Top finish	<b>Grommet options available in these finishes:</b>	T1 and T2 pricing includes powder coated base finish.
<b>VOF</b> Vector Base	2. Trim Finish (only applies if trim type is metal or leather)	Powder coated	There is an upcharge for plated base finishes as highlighted above.
<b>R</b> Rectangular	3. Base finish	Premium (Polished Chrome, Satin Nickel or Oil Rubbed Bronze)	For additional stone options and pricing please contact your sales representative."
<b>48</b> Depth	4. Grommet option	<b>Power Box Options</b>	
<b>84</b> Width	5. Grommet finish (only applies if grommets are selected)	<b>Code: Description:</b>	
<b>C</b> Corian	6. Power box option	NP No Power	
<b>F1</b> 1 Layer-Flat w/ Trim	7. Table-top power finish (only applies if table-top power is selected)	UCO Undermount	
<b>M</b> Metal Trim		ECO Edgemount	
<b>CS01</b> Top Finish	<b>Trim Type</b>	T1E Tabletop 1-Sided Lid	
<b>PM01</b> Trim Finish	N = No trim	T2C Tabletop 2-Sided Lid	
<b>MC01</b> Base Finish	M = Metal (available in Premium and Powder Coat finishes)	<b>Must select Wire Management Column and Finish:</b>	
<b>GM2</b> Grommet Opt.	L = Leather	Powder coated	
<b>MC01</b> Grommet Finish		Premium (Polished Chrome, Satin Nickel or Oil Rubbed Bronze)	
<b>UC0</b> Undermount			

# Rectangular Conference Tables

**48" Deep Tops**  
**2-Layer, Corian Tops**

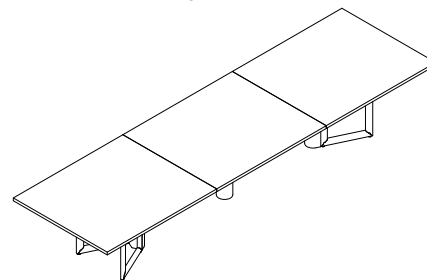

D	W	Pattern No.	CS01 Top	T__ Lower Layer	HG__ Lower Layer	PM__ Edge Upcharge	AU__ Edge Upcharge	PM__ Base Upcharge
48"	84"	<b>08VOFR4884CF2</b>	\$25,641	\$588	\$644	\$670	\$2,344	\$2,416
48"	96"	<b>08VOFR4896CF2</b>	27,337	648	714	724	2,556	2,416
48"	108"	<b>08VOFR48108CF2</b>	29,007	718	789	779	2,770	2,416
48"	120"	<b>08VOFR48120CF2</b>	30,727	819	900	834	2,982	2,416
48"	132"	<b>08VOFR48132CF2</b>	32,424	874	961	924	3,195	2,416
48"	144"	<b>08VOFR48144CF2</b>	34,119	929	1,020	979	3,409	2,416
48"	156"	<b>08VOFR48156CF2</b>	35,815	936	1,030	1,033	3,622	2,416
48"	168"	<b>08VOFR48168CF2</b>	39,859	1,031	1,135	1,087	3,835	4,083
48"	180"	<b>08VOFR48180CF2</b>	41,372	1,140	1,254	1,141	4,047	4,083
48"	192"	<b>08VOFR48192CF2</b>	42,884	1,166	1,285	1,195	4,261	4,083
48"	204"	<b>08VOFR48204CF2</b>	44,396	1,229	1,351	1,249	4,475	4,083
48"	216"	<b>08VOFR48216CF2</b>	45,909	1,298	1,428	1,268	4,686	4,083
48"	228"	<b>08VOFR48228CF2</b>	47,421	1,365	1,502	1,359	4,937	4,083
48"	240"	<b>08VOFR48240CF2</b>	48,933	1,468	1,615	1,413	5,113	4,083

Order Code	Specification Information	Refer To Accessories Section	Pricing Tiers
Example: <b>08VOFR4884CF2M-CS01-PM01-MC01-GM2-MC01-UCO</b>	To order please specify pattern number including:	Please refer to Accessories section, <a href="#">page 213</a> for power details.	Please refer to Materials and Finish <a href="#">page 9</a> for specification details.
<b>08</b> Highline Collection	1. Top finish	<b>Grommet options available in these finishes:</b>	T1 and T2 pricing includes powder coated base finish.
<b>VOF</b> Vector Base	2. Trim Finish (only applies if trim type is metal or leather)	Powder coated	There is an upcharge for plated base finishes as highlighted above.
<b>R</b> Rectangular	3. Base finish	Premium (Polished Chrome, Satin Nickel or Oil Rubbed Bronze)	For additional stone options and pricing please contact your sales representative."
<b>48</b> Depth	4. Grommet option	<b>Power Box Options</b>	
<b>84</b> Width	5. Grommet finish (only applies if grommets are selected)	<b>Code: Description:</b>	
<b>C</b> Corian	6. Power box option	NP No Power	
<b>F2</b> 2 Layer-Flat w/ Trim	7. Table-top power finish (only applies if table-top power is selected)	UCO Undermount	
<b>M</b> Metal Trim		ECO Edgemount	
<b>CS01</b> Top Finish	<b>Trim Type</b>	T1E Tabletop 1-Sided Lid	
<b>PM01</b> Trim Finish	N = No trim	T2C Tabletop 2-Sided Lid	
<b>MC01</b> Base Finish	M = Metal (available in Premium and Powder Coat finishes)	<b>Must select Wire Management Column and Finish:</b>	
<b>GM2</b> Grommet Opt.	L = Leather	Powder coated	
<b>MC01</b> Grommet Finish		Premium (Polished Chrome, Satin Nickel or Oil Rubbed Bronze)	
<b>UCO</b> Undermount			

# Rectangular Conference Tables

## 54" Deep Tops 1-Layer, Veneer Tops

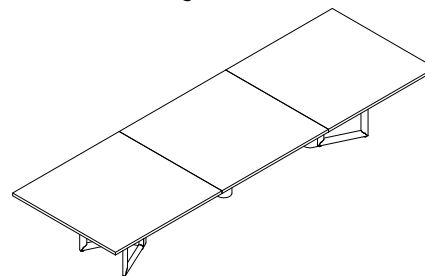

D	W	Pattern No.	T1__ Top	T2__ Top	MC__ Edge Upcharge	PM__ Edge Upcharge	AU__ Edge Upcharge	PM__ Base Upcharge
54"	84"	<b>08VOFR5484VF1</b>	\$16,429	\$17,341	\$2,569	\$3,270	\$5,040	\$2,416
54"	96"	<b>08VOFR5496VF1</b>	17,465	18,490	2,759	3,510	5,423	2,416
54"	108"	<b>08VOFR54108VF1</b>	18,500	19,654	2,952	3,758	5,827	2,416
54"	120"	<b>08VOFR54120VF1</b>	19,537	20,817	3,143	4,004	6,232	2,416
54"	132"	<b>08VOFR54132VF1</b>	20,571	21,981	3,335	4,285	6,637	2,416
54"	144"	<b>08VOFR54144VF1</b>	21,607	23,144	3,528	4,533	7,043	2,416
54"	156"	<b>08VOFR54156VF1</b>	22,643	24,307	3,718	4,778	7,446	2,416
54"	168"	<b>08VOFR54168VF1</b>	24,822	26,618	4,006	5,119	7,947	4,083
54"	180"	<b>08VOFR54180VF1</b>	25,707	27,628	4,003	5,170	8,157	4,083
54"	192"	<b>08VOFR54192VF1</b>	26,590	28,641	4,004	5,226	8,371	4,083
54"	204"	<b>08VOFR54204VF1</b>	27,475	29,655	4,003	5,280	8,583	4,083
54"	216"	<b>08VOFR54216VF1</b>	28,360	30,667	4,000	5,331	8,793	4,083
54"	228"	<b>08VOFR54228VF1</b>	29,244	31,680	4,000	5,385	9,006	4,083
54"	240"	<b>08VOFR54240VF1</b>	30,130	32,695	3,994	5,434	9,214	4,083

Order Code	Specification Information	Refer To Accessories Section	Pricing Tiers
Example: <b>08VOFR5484VF1M-T003-PM01-MC01-GM2-MC01-UC0</b>	To order please specify pattern number including:	Please refer to Accessories section, <b>page 213</b> for power details.	Please refer to Materials and Finish <b>page 9</b> for specification details.
<b>08</b> Highline Collection	1. Top finish	<b>Grommet options available in these finishes:</b>	T1 and T2 pricing includes powder coated base finish.
<b>VOF</b> Vector Base	2. Trim Finish (only applies if trim type is metal or leather)	Powder coated	There is an upcharge for plated base finishes as highlighted above.
<b>R</b> Rectangular	3. Base finish	Premium (Polished Chrome, Satin Nickel or Oil Rubbed Bronze)	For additional stone options and pricing please contact your sales representative."
<b>54</b> Depth	4. Grommet option	<b>Power Box Options</b>	
<b>84</b> Width	5. Grommet finish (only applies if grommets are selected)	<b>Code: Description:</b>	
<b>V</b> Veneer	6. Power box option	NP No Power	
<b>F1</b> 1 Layer-Flat w/ Trim	7. Table-top power finish (only applies if table-top power is selected)	UCO Undermount	
<b>M</b> Metal Trim		ECO Edgemount	
<b>T003</b> Top Finish	<b>Trim Type</b>	T1E Tabletop 1-Sided Lid	
<b>PM01</b> Trim Finish	N = No trim	T2C Tabletop 2-Sided Lid	
<b>MC01</b> Base Finish	M = Metal (available in Premium and Powder Coat finishes)	<b>Must select Wire Management Column and Finish:</b>	
<b>GM2</b> Grommet Opt.	L = Leather	Powder coated	
<b>MC01</b> Grommet Finish		Premium (Polished Chrome, Satin Nickel or Oil Rubbed Bronze)	
<b>UC0</b> Undermount			

# Rectangular Conference Tables

**54" Deep Tops**  
**2-Layer, Veneer Tops**

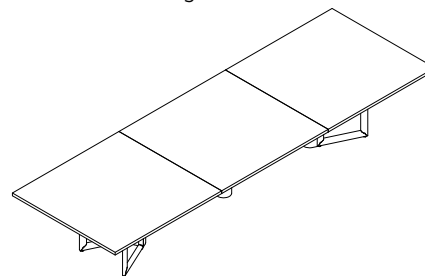

D	W	Pattern No.	T1__ Top	T2__ Top	T__ Lower Layer	HG__ Lower Layer	PM__ Edge Upcharge	AU__ Edge Upcharge	PM__ Base Upcharge
54"	84"	<b>08VOFR5484VF2</b>	\$21,214	\$22,012	\$617	\$738	\$701	\$2,471	\$2,416
54"	96"	<b>08VOFR5496VF2</b>	22,350	23,376	728	802	751	2,664	2,416
54"	108"	<b>08VOFR54108VF2</b>	23,486	24,641	806	888	806	2,875	2,416
54"	120"	<b>08VOFR54120VF2</b>	24,622	25,903	922	1,015	861	3,089	2,416
54"	132"	<b>08VOFR54132VF2</b>	25,757	27,168	982	1,081	950	3,302	2,416
54"	144"	<b>08VOFR54144VF2</b>	26,894	28,432	1,046	1,149	1,006	3,516	2,416
54"	156"	<b>08VOFR54156VF2</b>	28,024	29,691	1,053	1,157	1,060	3,728	2,416
54"	168"	<b>08VOFR54168VF2</b>	30,981	32,775	1,159	1,274	1,113	3,941	4,083
54"	180"	<b>08VOFR54180VF2</b>	31,848	33,770	1,283	1,410	1,167	4,155	4,083
54"	192"	<b>08VOFR54192VF2</b>	32,715	34,765	1,313	1,444	1,222	4,367	4,083
54"	204"	<b>08VOFR54204VF2</b>	33,581	35,762	1,383	1,521	1,277	4,580	4,083
54"	216"	<b>08VOFR54216VF2</b>	34,449	36,756	1,459	1,605	1,331	4,794	4,083
54"	228"	<b>08VOFR54228VF2</b>	35,316	37,750	1,536	1,690	1,386	5,006	4,083
54"	240"	<b>08VOFR54240VF2</b>	36,181	38,744	1,651	1,815	1,440	5,220	4,083

Order Code	Specification Information	Refer To Accessories Section	Pricing Tiers
Example: <b>08VOFR5484VF2M-T003-PM01-MC01-GM2-MC01-UC0</b>	To order please specify pattern number including:	Please refer to Accessories section, <a href="#">page 213</a> for power details.	Please refer to Materials and Finish <a href="#">page 9</a> for specification details.
<b>08</b> Highline Collection	1. Top finish	<b>Grommet options available in these finishes:</b>	T1 and T2 pricing includes powder coated base finish.
<b>VOF</b> Vector Base	2. Trim Finish (only applies if trim type is metal or leather)	Powder coated	There is an upcharge for plated base finishes as highlighted above.
<b>R</b> Rectangular	3. Base finish	Premium (Polished Chrome, Satin Nickel or Oil Rubbed Bronze)	For additional stone options and pricing please contact your sales representative."
<b>54</b> Depth	4. Grommet option	<b>Power Box Options</b>	
<b>84</b> Width	5. Grommet finish (only applies if grommets are selected)	<b>Code: Description:</b>	
<b>V</b> Veneer	6. Power box option	NP No Power	
<b>F2</b> 2 Layer-Flat w/ Trim	7. Table-top power finish (only applies if table-top power is selected)	UC0 Undermount	
<b>M</b> Metal Trim		ECO Edgemount	
<b>T003</b> Top Finish	<b>Trim Type</b>	T1E Tabletop 1-Sided Lid	
<b>PM01</b> Trim Finish	N = No trim	T2C Tabletop 2-Sided Lid	
<b>MC01</b> Base Finish	M = Metal (available in Premium and Powder Coat finishes)	<b>Must select Wire Management Column and Finish:</b>	
<b>GM2</b> Grommet Opt.	L = Leather	Powder coated	
<b>MC01</b> Grommet Finish		Premium (Polished Chrome, Satin Nickel or Oil Rubbed Bronze)	
<b>UC0</b> Undermount			

# Rectangular Conference Tables

**54" Deep Tops**  
**Slab Top, Veneer Tops**

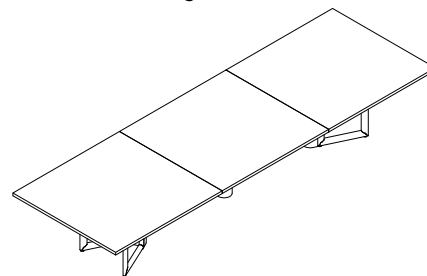

D	W	Pattern No.	T1__ Top	T2__ Top	MC__ Edge Upcharge	PM__ Edge Upcharge	AU__ Edge Upcharge	PM__ Base Upcharge
54"	84"	<b>08VOFR5484VSF</b>	\$18,648	\$19,558	\$2,566	\$3,267	\$5,037	\$2,416
54"	96"	<b>08VOFR5496VSF</b>	19,591	20,616	2,759	3,510	5,423	2,416
54"	108"	<b>08VOFR54108VSF</b>	20,535	21,689	2,951	3,757	5,826	2,416
54"	120"	<b>08VOFR54120VSF</b>	21,479	22,760	3,143	4,004	6,232	2,416
54"	132"	<b>08VOFR54132VSF</b>	22,422	23,832	3,335	4,285	6,637	2,416
54"	144"	<b>08VOFR54144VSF</b>	23,366	24,903	3,528	4,533	7,043	2,416
54"	156"	<b>08VOFR54156VSF</b>	24,306	25,973	3,718	4,778	7,446	2,416
54"	168"	<b>08VOFR54168VSF</b>	26,974	28,769	4,006	5,119	7,947	4,083
54"	180"	<b>08VOFR54180VSF</b>	27,843	29,766	4,005	5,172	8,160	4,083
54"	192"	<b>08VOFR54192VSF</b>	28,711	30,762	4,004	5,226	8,371	4,083
54"	204"	<b>08VOFR54204VSF</b>	29,580	31,759	4,002	5,279	8,582	4,083
54"	216"	<b>08VOFR54216VSF</b>	30,448	32,755	4,001	5,332	8,794	4,083
54"	228"	<b>08VOFR54228VSF</b>	31,316	33,752	4,000	5,385	9,006	4,083
54"	240"	<b>08VOFR54240VSF</b>	32,187	34,751	3,994	5,434	9,214	4,083

Order Code	Specification Information	Refer To Accessories Section	Pricing Tiers
Example: <b>08VOFR5484VSFM-T003-PM01-MC01-GM2-MC01-UC0</b>	To order please specify pattern number including:	Please refer to Accessories section, <a href="#">page 213</a> for power details.	Please refer to Materials and Finish <a href="#">page 9</a> for specification details.
<b>08</b> Highline Collection	1. Top finish	<b>Grommet options available in these finishes:</b>	T1 and T2 pricing includes powder coated base finish.
<b>VOF</b> Vector Base	2. Trim Finish (only applies if trim type is metal or leather)	Powder coated	There is an upcharge for plated base finishes as highlighted above.
<b>R</b> Rectangular	3. Base finish	Premium (Polished Chrome, Satin Nickel or Oil Rubbed Bronze)	For additional stone options and pricing please contact your sales representative."
<b>54</b> Depth	4. Grommet option	<b>Power Box Options</b>	
<b>84</b> Width	5. Grommet finish (only applies if grommets are selected)	<b>Code: Description:</b>	
<b>V</b> Veneer	6. Power box option	NP No Power	
<b>SF</b> Slab	7. Table-top power finish (only applies if table-top power is selected)	UC0 Undermount	
<b>M</b> Metal Trim		ECO Edgemount	
<b>T003</b> Top Finish	<b>Trim Type</b>	T1E Tabletop 1-Sided Lid	
<b>PM01</b> Trim Finish	N = No trim	T2C Tabletop 2-Sided Lid	
<b>MC01</b> Base Finish	M = Metal (available in Premium and Powder Coat finishes)	<b>Must select Wire Management Column and Finish:</b>	
<b>GM2</b> Grommet Opt.	L = Leather	Powder coated	
<b>MC01</b> Grommet Finish		Premium (Polished Chrome, Satin Nickel or Oil Rubbed Bronze)	
<b>UC0</b> Undermount			





# Rectangular Conference Tables

**54" Deep Tops**  
**1-Layer, Glass Tops**

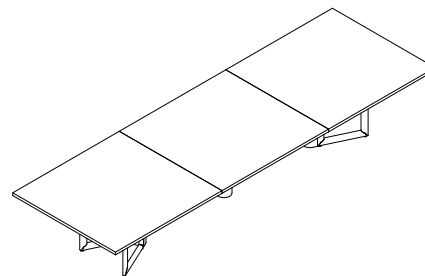

D	W	Pattern No.	GC__ Top	GE__ Top	PM__ Edge Upcharge	AU__ Edge Upcharge	PM__ Base Upcharge
54"	84"	<b>08VOFR5484GF1</b>	\$23,865	\$24,649	\$701	\$2,471	\$2,416
54"	96"	<b>08VOFR5496GF1</b>	25,681	26,610	751	2,664	2,416
54"	108"	<b>08VOFR54108GF1</b>	27,536	28,581	806	2,875	2,416
54"	120"	<b>08VOFR54120GF1</b>	29,388	30,550	861	3,089	2,416
54"	132"	<b>08VOFR54132GF1</b>	31,242	32,521	950	3,302	2,416
54"	144"	<b>08VOFR54144GF1</b>	33,097	34,492	1,006	3,516	2,416
54"	156"	<b>08VOFR54156GF1</b>	34,950	36,460	1,060	3,728	2,416
54"	168"	<b>08VOFR54168GF1</b>	38,098	39,724	1,113	3,941	4,083
54"	180"	<b>08VOFR54180GF1</b>	39,592	41,335	1,167	4,155	4,083
54"	192"	<b>08VOFR54192GF1</b>	41,088	42,947	1,222	4,367	4,083
54"	204"	<b>08VOFR54204GF1</b>	42,584	44,560	1,277	4,580	4,083
54"	216"	<b>08VOFR54216GF1</b>	44,079	46,170	1,331	4,794	4,083
54"	228"	<b>08VOFR54228GF1</b>	45,576	47,783	1,386	5,006	4,083
54"	240"	<b>08VOFR54240GF1</b>	47,067	49,391	1,440	5,220	4,083

Order Code	Specification Information	Refer To Accessories Section	Pricing Tiers
Example: <b>08VOFR5484GF1M-GE01-PM01-MC01-GM2-MC01-UC0</b>	To order please specify pattern number including:	Please refer to Accessories section, <a href="#">page 213</a> for power details.	Please refer to Materials and Finish <a href="#">page 9</a> for specification details.
<b>08</b> Highline Collection	1. Top finish	<b>Grommet options available in these finishes:</b>	T1 and T2 pricing includes powder coated base finish.
<b>VOF</b> Vector Base	2. Trim Finish (only applies if trim type is metal or leather)	Powder coated	There is an upcharge for plated base finishes as highlighted above.
<b>R</b> Rectangular	3. Base finish	Premium (Polished Chrome, Satin Nickel or Oil Rubbed Bronze)	For additional stone options and pricing please contact your sales representative."
<b>54</b> Depth	4. Grommet option	<b>Power Box Options</b>	
<b>84</b> Width	5. Grommet finish (only applies if grommets are selected)	<b>Code: Description:</b>	
<b>G</b> Glass	6. Power box option	NP No Power	
<b>F1</b> 1 Layer-Flat w/ Trim	7. Table-top power finish (only applies if table-top power is selected)	UCO Undermount	
<b>M</b> Metal Trim		ECO Edgemount	
<b>GE01</b> Top Finish	<b>Trim Type</b>	T1E Tabletop 1-Sided Lid	
<b>PM01</b> Trim Finish	N = No trim	T2C Tabletop 2-Sided Lid	
<b>MC01</b> Base Finish	M = Metal (available in Premium and Powder Coat finishes)	<b>Must select Wire Management Column and Finish:</b>	
<b>GM2</b> Grommet Opt.	L = Leather	Powder coated	
<b>MC01</b> Grommet Finish		Premium (Polished Chrome, Satin Nickel or Oil Rubbed Bronze)	
<b>UC0</b> Undermount			



# Rectangular Conference Tables

**54" Deep Tops**  
**2-Layer, Glass Tops**

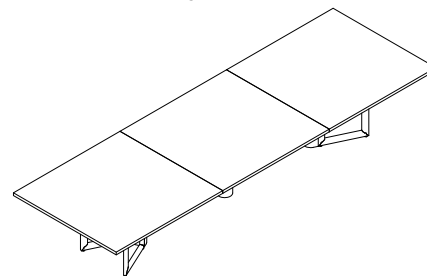

D	W	Pattern No.	GC__ Top	GE__ Top	T__ Lower Layer	HG__ Lower Layer	PM__ Edge Upcharge	AU__ Edge Upcharge	PM__ EdgeBase Upcharge
54"	84"	<b>08VOFR5484GF2</b>	\$25,689	\$26,412	\$617	\$738	\$701	\$2,471	\$2,416
54"	96"	<b>08VOFR5496GF2</b>	27,895	28,824	728	802	751	2,664	2,416
54"	108"	<b>08VOFR54108GF2</b>	29,655	30,700	806	888	806	2,875	2,416
54"	120"	<b>08VOFR54120GF2</b>	31,414	32,576	922	1,015	861	3,089	2,416
54"	132"	<b>08VOFR54132GF2</b>	33,172	34,449	982	1,081	950	3,302	2,416
54"	144"	<b>08VOFR54144GF2</b>	34,930	36,325	1,046	1,149	1,006	3,516	2,416
54"	156"	<b>08VOFR54156GF2</b>	36,685	38,194	1,053	1,157	1,060	3,728	2,416
54"	168"	<b>08VOFR54168GF2</b>	40,341	41,968	1,159	1,274	1,113	3,941	4,083
54"	180"	<b>08VOFR54180GF2</b>	41,820	43,562	1,283	1,410	1,167	4,155	4,083
54"	192"	<b>08VOFR54192GF2</b>	43,298	45,157	1,313	1,444	1,222	4,367	4,083
54"	204"	<b>08VOFR54204GF2</b>	44,777	46,753	1,383	1,521	1,277	4,580	4,083
54"	216"	<b>08VOFR54216GF2</b>	46,257	48,348	1,459	1,605	1,331	4,794	4,083
54"	228"	<b>08VOFR54228GF2</b>	47,735	49,942	1,536	1,690	1,386	5,006	4,083
54"	240"	<b>08VOFR54240GF2</b>	49,211	51,534	1,651	1,815	1,440	5,220	4,083

Order Code	Specification Information	Refer To Accessories Section	Pricing Tiers
Example: <b>08VOFR5484GF2M-GE01-PM01-MC01-GM2-MC01-UC0</b>	To order please specify pattern number including:	Please refer to Accessories section, <a href="#">page 213</a> for power details.	Please refer to Materials and Finish <a href="#">page 9</a> for specification details.
<b>08</b> Highline Collection	1. Top finish	<b>Grommet options available in these finishes:</b>	T1 and T2 pricing includes powder coated base finish.
<b>VOF</b> Vector Base	2. Trim Finish (only applies if trim type is metal or leather)	Powder coated	There is an upcharge for plated base finishes as highlighted above.
<b>R</b> Rectangular	3. Base finish	Premium (Polished Chrome, Satin Nickel or Oil Rubbed Bronze)	For additional stone options and pricing please contact your sales representative."
<b>54</b> Depth	4. Grommet option	<b>Power Box Options</b>	
<b>84</b> Width	5. Grommet finish (only applies if grommets are selected)	<b>Code: Description:</b>	
<b>G</b> Glass	6. Power box option	NP No Power	
<b>F2</b> 2 Layer-Flat w/ Trim	7. Table-top power finish (only applies if table-top power is selected)	UCO Undermount	
<b>M</b> Metal Trim		ECO Edgemount	
<b>GE01</b> Top Finish	<b>Trim Type</b>	T1E Tabletop 1-Sided Lid	
<b>PM01</b> Trim Finish	N = No trim	T2C Tabletop 2-Sided Lid	
<b>MC01</b> Base Finish	M = Metal (available in Premium and Powder Coat finishes)	<b>Must select Wire Management Column and Finish:</b>	
<b>GM2</b> Grommet Opt.	L = Leather	Powder coated	
<b>MC01</b> Grommet Finish		Premium (Polished Chrome, Satin Nickel or Oil Rubbed Bronze)	
<b>UC0</b> Undermount			

# Rectangular Conference Tables

**54" Deep Tops**  
**1-Layer, Corian Tops**

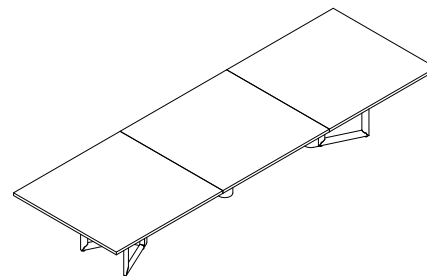

D	W	Pattern No.	CS01 Top	MC__ Edge Upcharge	PM__ Edge Upcharge	AU__ Edge Upcharge	PM__ Base Upcharge
54"	84"	<b>08VOFR5484CF1</b>	\$22,090	\$2,567	\$3,269	\$5,038	\$2,416
54"	96"	<b>08VOFR5496CF1</b>	23,931	2,759	3,510	5,423	2,416
54"	108"	<b>08VOFR54108CF1</b>	25,775	2,952	3,758	5,827	2,416
54"	120"	<b>08VOFR54120CF1</b>	27,618	3,143	4,004	6,232	2,416
54"	132"	<b>08VOFR54132CF1</b>	29,460	3,336	4,286	6,638	2,416
54"	144"	<b>08VOFR54144CF1</b>	31,305	3,527	4,532	7,042	2,416
54"	156"	<b>08VOFR54156CF1</b>	33,148	3,717	4,777	7,445	2,416
54"	168"	<b>08VOFR54168CF1</b>	36,137	4,006	5,119	7,947	4,083
54"	180"	<b>08VOFR54180CF1</b>	37,828	4,005	5,172	8,160	4,083
54"	192"	<b>08VOFR54192CF1</b>	39,524	4,002	5,223	8,369	4,083
54"	204"	<b>08VOFR54204CF1</b>	41,215	4,002	5,279	8,582	4,083
54"	216"	<b>08VOFR54216CF1</b>	42,906	4,002	5,333	8,795	4,083
54"	228"	<b>08VOFR54228CF1</b>	44,599	4,000	5,385	9,006	4,083
54"	240"	<b>08VOFR54240CF1</b>	46,294	3,993	5,433	9,213	4,083

Order Code	Specification Information	Refer To Accessories Section	Pricing Tiers
Example: <b>08VOFR5484CF1M-CS01-PM01-MC01-GM2-MC01-UCO</b>	To order please specify pattern number including:	Please refer to Accessories section, <a href="#">page 213</a> for power details.	Please refer to Materials and Finish <a href="#">page 9</a> for specification details.
<b>08</b> Highline Collection	1. Top finish	<b>Grommet options available in these finishes:</b>	T1 and T2 pricing includes powder coated base finish.
<b>VOF</b> Vector Base	2. Trim Finish (only applies if trim type is metal or leather)	Powder coated	There is an upcharge for plated base finishes as highlighted above.
<b>R</b> Rectangular	3. Base finish	Premium (Polished Chrome, Satin Nickel or Oil Rubbed Bronze)	For additional stone options and pricing please contact your sales representative."
<b>54</b> Depth	4. Grommet option	<b>Power Box Options</b>	
<b>84</b> Width	5. Grommet finish (only applies if grommets are selected)	<b>Code: Description:</b>	
<b>C</b> Corian	6. Power box option	NP No Power	
<b>F1</b> 1 Layer-Flat w/ Trim	7. Table-top power finish (only applies if table-top power is selected)	UCO Undermount	
<b>M</b> Metal Trim	<b>Trim Type</b>	ECO Edgemount	
<b>CS01</b> Top Finish	N = No trim	T1E Tabletop 1-Sided Lid	
<b>PM01</b> Trim Finish	M = Metal (available in Premium and Powder Coat finishes)	T2C Tabletop 2-Sided Lid	
<b>MC01</b> Base Finish	L = Leather	<b>Must select Wire Management Column and Finish:</b>	
<b>GM2</b> Grommet Opt.		Powder coated	
<b>MC01</b> Grommet Finish		Premium (Polished Chrome, Satin Nickel or Oil Rubbed Bronze)	
<b>UCO</b> Undermount			

# Rectangular Conference Tables

**54" Deep Tops**  
**2-Layer, Corian Tops**

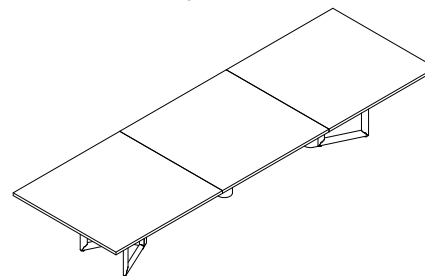

D	W	Pattern No.	CS01 Top	T__ Lower Layer	HG__ Lower Layer	PM__ Edge Upcharge	AU__ Edge Upcharge	PM__ Base Upcharge
54"	84"	<b>08VOFR5484CF2</b>	\$26,242	\$617	\$738	\$701	\$2,471	\$2,416
54"	96"	<b>08VOFR5496CF2</b>	28,815	728	802	751	2,664	2,416
54"	108"	<b>08VOFR54108CF2</b>	30,760	806	888	806	2,875	2,416
54"	120"	<b>08VOFR54120CF2</b>	32,703	922	1,015	861	3,089	2,416
54"	132"	<b>08VOFR54132CF2</b>	34,647	982	1,081	950	3,302	2,416
54"	144"	<b>08VOFR54144CF2</b>	36,591	1,046	1,149	1,006	3,516	2,416
54"	156"	<b>08VOFR54156CF2</b>	38,530	1,053	1,157	1,060	3,728	2,416
54"	168"	<b>08VOFR54168CF2</b>	42,295	1,159	1,274	1,113	3,941	4,083
54"	180"	<b>08VOFR54180CF2</b>	43,970	1,283	1,410	1,167	4,155	4,083
54"	192"	<b>08VOFR54192CF2</b>	45,646	1,313	1,444	1,222	4,367	4,083
54"	204"	<b>08VOFR54204CF2</b>	47,321	1,383	1,521	1,277	4,580	4,083
54"	216"	<b>08VOFR54216CF2</b>	48,996	1,459	1,605	1,331	4,794	4,083
54"	228"	<b>08VOFR54228CF2</b>	50,670	1,536	1,690	1,386	5,006	4,083
54"	240"	<b>08VOFR54240CF2</b>	52,343	1,651	1,815	1,440	5,220	4,083

Order Code	Specification Information	Refer To Accessories Section	Pricing Tiers
Example: <b>08VOFR5484CF2M-CS01-PM01-MC01-GM2-MC01-UCO</b>	To order please specify pattern number including:	Please refer to Accessories section, <a href="#">page 213</a> for power details.	Please refer to Materials and Finish <a href="#">page 9</a> for specification details.
<b>08</b> Highline Collection	1. Top finish	<b>Grommet options available in these finishes:</b>	T1 and T2 pricing includes powder coated base finish.
<b>VOF</b> Vector Base	2. Trim Finish (only applies if trim type is metal or leather)	Powder coated	There is an upcharge for plated base finishes as highlighted above.
<b>R</b> Rectangular	3. Base finish	Premium (Polished Chrome, Satin Nickel or Oil Rubbed Bronze)	For additional stone options and pricing please contact your sales representative."
<b>54</b> Depth	4. Grommet option	<b>Power Box Options</b>	
<b>84</b> Width	5. Grommet finish (only applies if grommets are selected)	<b>Code: Description:</b>	
<b>C</b> Corian	6. Power box option	NP No Power	
<b>F2</b> 2 Layer-Flat w/ Trim	7. Table-top power finish (only applies if table-top power is selected)	UCO Undermount	
<b>M</b> Metal Trim		ECO Edgemount	
<b>CS01</b> Top Finish	<b>Trim Type</b>	T1E Tabletop 1-Sided Lid	
<b>PM01</b> Trim Finish	N = No trim	T2C Tabletop 2-Sided Lid	
<b>MC01</b> Base Finish	M = Metal (available in Premium and Powder Coat finishes)	<b>Must select Wire Management Column and Finish:</b>	
<b>GM2</b> Grommet Opt.	L = Leather	Powder coated	
<b>MC01</b> Grommet Finish		Premium (Polished Chrome, Satin Nickel or Oil Rubbed Bronze)	
<b>UCO</b> Undermount			

# Highline Vector Conference Tables

## 60" Deep Conference Tables

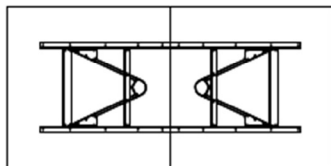
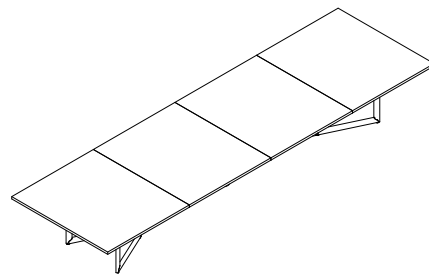

**120L**  
SEATS 12

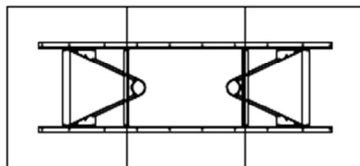

**132L**  
SEATS 12

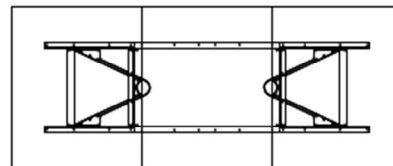

**144L**  
SEATS 12

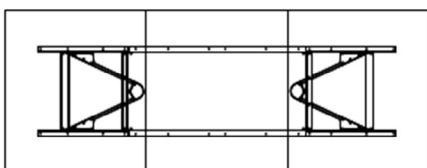

**156L**  
SEATS 12

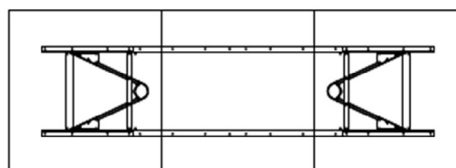

**168L**  
SEATS 14

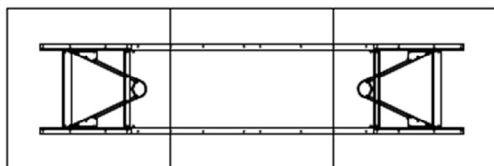

**180L**  
SEATS 16

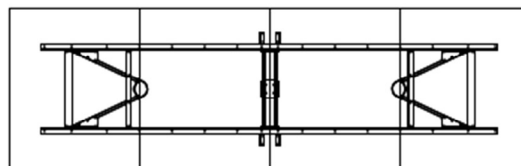

**192L**  
SEATS 16

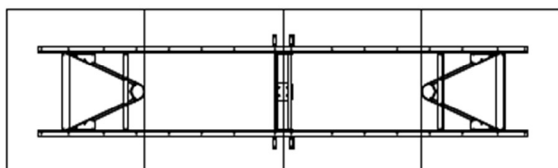

**204L**  
SEATS 16

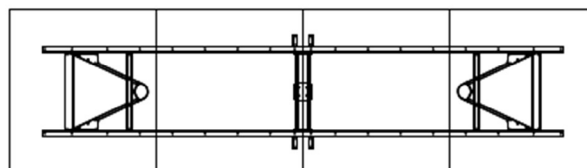

**216L**  
SEATS 18

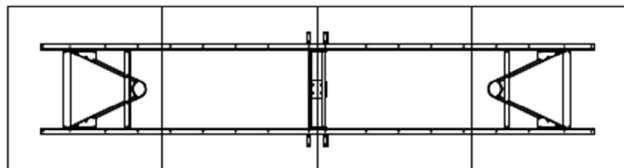

**228L**  
SEATS 18

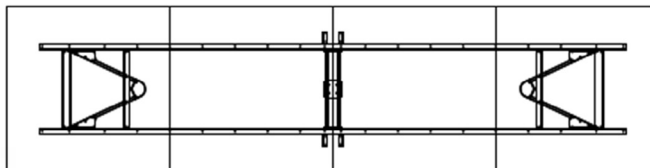

**240L**  
SEATS 20

# Highline Vector Conference Tables

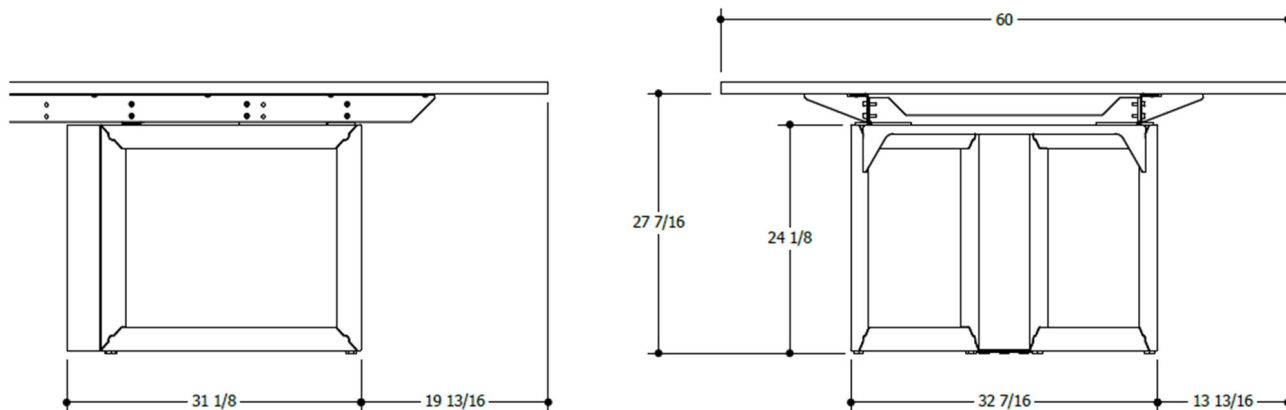
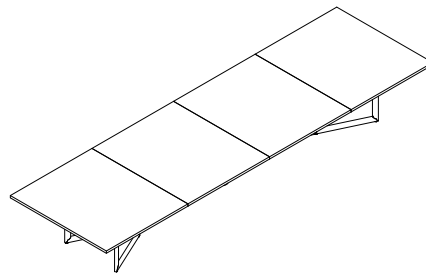

END BASE ELEVATION, 60D

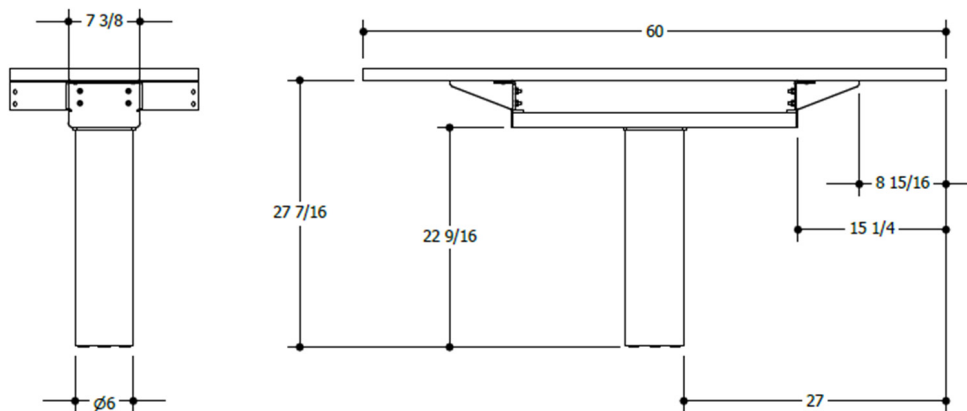

SIDE ELEVATION

END ELEVATION, 60D

# Rectangular Conference Tables

**60" Deep Tops**  
**1-Layer, Veneer Tops**

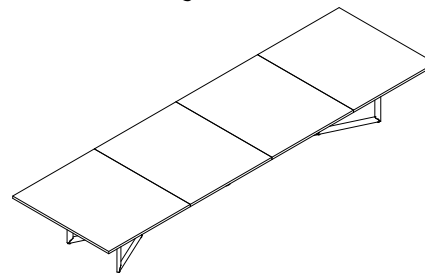

D	W	Pattern No.	T1__ Top	T2__ Top	MC__ Edge Upcharge	PM__ Edge Upcharge	AU__ Edge Upcharge	PM__ Base Upcharge
60"	120"	<b>08VOFR60120VF1</b>	\$17,438	\$18,861	\$2,542	\$3,430	\$5,737	\$2,536
60"	132"	<b>08VOFR60132VF1</b>	19,204	20,772	2,787	3,766	6,196	2,536
60"	144"	<b>08VOFR60144VF1</b>	20,971	22,680	3,028	4,062	6,650	2,536
60"	156"	<b>08VOFR60156VF1</b>	22,737	24,589	3,273	4,360	8,111	2,536
60"	168"	<b>08VOFR60168VF1</b>	24,502	26,497	3,518	4,659	7,565	2,536
60"	180"	<b>08VOFR60180VF1</b>	26,266	28,403	3,764	4,959	8,025	2,536
60"	192"	<b>08VOFR60192VF1</b>	28,448	30,726	4,004	5,253	8,479	4,204
60"	204"	<b>08VOFR60204VF1</b>	29,458	31,880	3,987	5,292	8,674	4,204
60"	216"	<b>08VOFR60216VF1</b>	30,469	33,033	3,970	5,329	8,870	4,204
60"	228"	<b>08VOFR60228VF1</b>	31,480	34,186	3,951	5,364	9,063	4,204
60"	240"	<b>08VOFR60240VF1</b>	32,491	35,340	3,935	5,403	9,261	4,204

Order Code	Specification Information	Refer To Accessories Section	Pricing Tiers
Example: <b>08VOFR60120VF1M-T003-PM01-MC01-GM2-MC01-UCO</b>	To order please specify pattern number including:	Please refer to Accessories section, <a href="#">page 213</a> for power details.	Please refer to Materials and Finish <a href="#">page 9</a> for specification details.
<b>08</b> Highline Collection	1. Top finish	<b>Grommet options available in these finishes:</b>	T1 and T2 pricing includes powder coated base finish.
<b>VOF</b> Vector Base	2. Trim Finish (only applies if trim type is metal or leather)	Powder coated	There is an upcharge for plated base finishes as highlighted above.
<b>R</b> Rectangular	3. Base finish	Premium (Polished Chrome, Satin Nickel or Oil Rubbed Bronze)	For additional stone options and pricing please contact your sales representative."
<b>60</b> Depth	4. Grommet option	<b>Power Box Options</b>	
<b>120</b> Width	5. Grommet finish (only applies if grommets are selected)	<b>Code: Description:</b>	
<b>V</b> Veneer	6. Power box option	NP No Power	
<b>F1</b> 1 Layer-Flat w/ Trim	7. Table-top power finish (only applies if table-top power is selected)	UCO Undermount	
<b>M</b> Metal Trim		ECO Edgemount	
<b>T003</b> Top Finish	<b>Trim Type</b>	T1E Tabletop 1-Sided Lid	
<b>PM01</b> Trim Finish	N = No trim	T2C Tabletop 2-Sided Lid	
<b>MC01</b> Base Finish	M = Metal (available in Premium and Powder Coat finishes)	<b>Must select Wire Management</b>	
<b>GM2</b> Grommet Opt.	L = Leather	<b>Column and Finish:</b>	
<b>MC01</b> Grommet Finish		Powder coated	
<b>UCO</b> Undermount		Premium (Polished Chrome, Satin Nickel or Oil Rubbed Bronze)	

# Rectangular Conference Tables

**60" Deep Tops**  
**2-Layer, Veneer Tops**

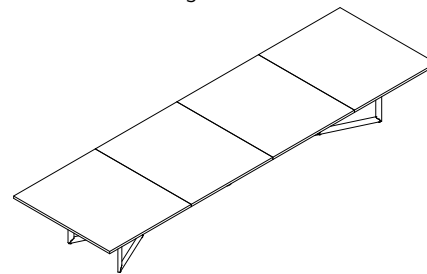

D	W	Pattern No.	T1__ Top	T2__ Top	T__ Lower Layer	HG__ Lower Layer	PM__ Edge Upcharge	AU__ Edge Upcharge	PM__ Base Upcharge
60"	120"	<b>08VOFR60120VF2</b>	\$22,121	\$23,545	\$894	\$984	\$888	\$3,195	\$2,536
60"	132"	<b>08VOFR60132VF2</b>	23,971	25,537	996	1,095	979	3,409	2,536
60"	144"	<b>08VOFR60144VF2</b>	25,819	27,528	1,058	1,164	1,033	3,622	2,536
60"	156"	<b>08VOFR60156VF2</b>	27,669	29,521	1,133	1,246	1,087	4,838	2,536
60"	168"	<b>08VOFR60168VF2</b>	29,519	31,511	1,194	1,314	1,141	4,047	2,536
60"	180"	<b>08VOFR60180VF2</b>	31,369	33,506	1,235	1,360	1,195	4,261	2,536
60"	192"	<b>08VOFR60192VF2</b>	34,068	36,347	1,345	1,481	1,249	4,475	4,204
60"	204"	<b>08VOFR60204VF2</b>	35,075	37,497	1,419	1,562	1,305	4,686	4,204
60"	216"	<b>08VOFR60216VF2</b>	36,082	38,646	1,454	1,600	1,359	4,900	4,204
60"	228"	<b>08VOFR60228VF2</b>	37,089	39,796	1,571	1,728	1,413	5,113	4,204
60"	240"	<b>08VOFR60240VF2</b>	38,094	40,942	1,645	1,811	1,468	5,325	4,204

Order Code	Specification Information	Refer To Accessories Section	Pricing Tiers
Example: <b>08VOFR60120VF2M-T003-PM01-MC01-GM2-MC01-UCO</b>	To order please specify pattern number including:	Please refer to Accessories section, <a href="#">page 213</a> for power details.	Please refer to Materials and Finish <a href="#">page 9</a> for specification details.
<b>08</b> Highline Collection	1. Top finish	<b>Grommet options available in these finishes:</b>	T1 and T2 pricing includes powder coated base finish.
<b>VOF</b> Vector Base	2. Trim Finish (only applies if trim type is metal or leather)	Powder coated	There is an upcharge for plated base finishes as highlighted above.
<b>R</b> Rectangular	3. Base finish	Premium (Polished Chrome, Satin Nickel or Oil Rubbed Bronze)	For additional stone options and pricing please contact your sales representative."
<b>60</b> Depth	4. Grommet option	<b>Power Box Options</b>	
<b>120</b> Width	5. Grommet finish (only applies if grommets are selected)	<b>Code: Description:</b>	
<b>V</b> Veneer	6. Power box option	NP No Power	
<b>F2</b> 2 Layer-Flat w/ Trim	7. Table-top power finish (only applies if table-top power is selected)	UCO Undermount	
<b>M</b> Metal Trim		ECO Edgemount	
<b>T003</b> Top Finish	<b>Trim Type</b>	T1E Tabletop 1-Sided Lid	
<b>PM01</b> Trim Finish	N = No trim	T2C Tabletop 2-Sided Lid	
<b>MC01</b> Base Finish	M = Metal (available in Premium and Powder Coat finishes)	<b>Must select Wire Management</b>	
<b>GM2</b> Grommet Opt.	L = Leather	<b>Column and Finish:</b>	
<b>MC01</b> Grommet Finish		Powder coated	
<b>UCO</b> Undermount		Premium (Polished Chrome, Satin Nickel or Oil Rubbed Bronze)	

# Rectangular Conference Tables

**60" Deep Tops**  
**Slab Top, Veneer Tops**

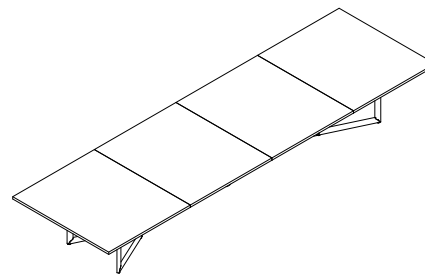

D	W	Pattern No.	T1__ Top	T2__ Top	MC__ Edge Upcharge	PM__ Edge Upcharge	AU__ Edge Upcharge	PM__ Base Upcharge
60"	120"	<b>08VOFR60120VSF</b>	\$19,579	\$21,003	\$2,542	\$3,430	\$5,737	\$2,536
60"	132"	<b>08VOFR60132VSF</b>	21,184	22,751	2,787	3,766	6,196	2,536
60"	144"	<b>08VOFR60144VSF</b>	22,790	24,499	3,029	4,063	6,651	2,536
60"	156"	<b>08VOFR60156VSF</b>	24,395	26,247	3,274	4,361	8,112	2,536
60"	168"	<b>08VOFR60168VSF</b>	26,001	27,995	3,518	4,659	7,565	2,536
60"	180"	<b>08VOFR60180VSF</b>	27,606	29,743	3,764	4,959	8,025	2,536
60"	192"	<b>08VOFR60192VSF</b>	30,065	32,343	4,003	5,252	8,478	4,204
60"	204"	<b>08VOFR60204VSF</b>	31,088	33,510	3,987	5,292	8,674	4,204
60"	216"	<b>08VOFR60216VSF</b>	32,112	34,677	3,971	5,330	8,871	4,204
60"	228"	<b>08VOFR60228VSF</b>	33,137	35,843	3,952	5,365	9,065	4,204
60"	240"	<b>08VOFR60240VSF</b>	34,158	37,007	3,935	5,403	9,261	4,204

Order Code	Specification Information	Refer To Accessories Section	Pricing Tiers
Example: <b>08VOFR60120VSFM-T003-PM01-MC01-GM2-MC01-UCO</b>	To order please specify pattern number including:	Please refer to Accessories section, <a href="#">page 213</a> for power details.	Please refer to Materials and Finish <a href="#">page 9</a> for specification details.
<b>08</b> Highline Collection	1. Top finish	<b>Grommet options available in these finishes:</b>	T1 and T2 pricing includes powder coated base finish.
<b>VOF</b> Vector Base	2. Trim Finish (only applies if trim type is metal or leather)	Powder coated	There is an upcharge for plated base finishes as highlighted above.
<b>R</b> Rectangular	3. Base finish	Premum (Polished Chrome, Satin Nickel or Oil Rubbed Bronze)	For additional stone options and pricing please contact your sales representative."
<b>60</b> Depth	4. Grommet option	<b>Power Box Options</b>	
<b>120</b> Width	5. Grommet finish (only applies if grommets are selected)	<b>Code: Description:</b>	
<b>V</b> Veneer	6. Power box option	NP No Power	
<b>SF</b> Slab	7. Table-top power finish (only applies if table-top power is selected)	UCO Undermount	
<b>M</b> Metal Trim		ECO Edgemount	
<b>T003</b> Top Finish	<b>Trim Type</b>	T1E Tabletop 1-Sided Lid	
<b>PM01</b> Trim Finish	N = No trim	T2C Tabletop 2-Sided Lid	
<b>MC01</b> Base Finish	M = Metal (available in Premium and Powder Coat finishes)	<b>Must select Wire Management</b>	
<b>GM2</b> Grommet Opt.	L = Leather	<b>Column and Finish:</b>	
<b>MC01</b> Grommet Finish		Powder coated	
<b>UCO</b> Undermount		Premium (Polished Chrome, Satin Nickel or Oil Rubbed Bronze)	





# Rectangular Conference Tables

**60" Deep Tops**  
**1-Layer, Glass Tops**

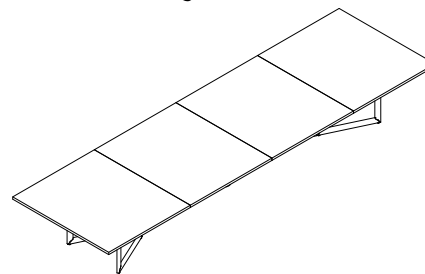

D	W	Pattern No.	GC__ Top	GE__ Top	PM__ Edge Upcharge	AU__ Edge Upcharge	PM__ Base Upcharge
60"	120"	<b>08VOFR60120GF1</b>	\$27,214	\$28,504	\$888	\$3,195	\$2,536
60"	132"	<b>08VOFR60132GF1</b>	29,947	31,368	979	3,409	2,536
60"	144"	<b>08VOFR60144GF1</b>	32,682	34,231	1,033	3,622	2,536
60"	156"	<b>08VOFR60156GF1</b>	35,417	37,095	1,087	4,838	2,536
60"	168"	<b>08VOFR60168GF1</b>	33,968	39,958	1,141	4,047	2,536
60"	180"	<b>08VOFR60180GF1</b>	40,884	42,820	1,195	4,261	2,536
60"	192"	<b>08VOFR60192GF1</b>	44,047	46,113	1,249	4,475	4,204
60"	204"	<b>08VOFR60204GF1</b>	45,722	47,916	1,305	4,686	4,204
60"	216"	<b>08VOFR60216GF1</b>	47,396	49,720	1,359	4,900	4,204
60"	228"	<b>08VOFR60228GF1</b>	49,070	51,523	1,413	5,113	4,204
60"	240"	<b>08VOFR60240GF1</b>	50,746	53,328	1,468	5,325	4,204

Order Code	Specification Information	Refer To Accessories Section	Pricing Tiers
Example: <b>08VOFR60120GF1M-GE01-PM01-MC01-GM2-MC01-UCO</b>	To order please specify pattern number including:	Please refer to Accessories section, <a href="#">page 213</a> for power details.	Please refer to Materials and Finish <a href="#">page 9</a> for specification details.
<b>08</b> Highline Collection	1. Top finish	<b>Grommet options available in these finishes:</b>	T1 and T2 pricing includes powder coated base finish.
<b>VOF</b> Vector Base	2. Trim Finish (only applies if trim type is metal or leather)	Powder coated	There is an upcharge for plated base finishes as highlighted above.
<b>R</b> Rectangular	3. Base finish	Premium (Polished Chrome, Satin Nickel or Oil Rubbed Bronze)	For additional stone options and pricing please contact your sales representative."
<b>60</b> Depth	4. Grommet option	<b>Power Box Options</b>	
<b>120</b> Width	5. Grommet finish (only applies if grommets are selected)	<b>Code: Description:</b>	
<b>G</b> Glass	6. Power box option	NP No Power	
<b>F1</b> 1 Layer-Flat w/ Trim	7. Table-top power finish (only applies if table-top power is selected)	UCO Undermount	
<b>M</b> Metal Trim		ECO Edgemount	
<b>GE01</b> Top Finish	<b>Trim Type</b>	T1E Tabletop 1-Sided Lid	
<b>PM01</b> Trim Finish	N = No trim	T2C Tabletop 2-Sided Lid	
<b>MC01</b> Base Finish	M = Metal (available in Premium and Powder Coat finishes)	<b>Must select Wire Management</b>	
<b>GM2</b> Grommet Opt.	L = Leather	<b>Column and Finish:</b>	
<b>MC01</b> Grommet Finish		Powder coated	
<b>UCO</b> Undermount		Premium (Polished Chrome, Satin Nickel or Oil Rubbed Bronze)	

# Rectangular Conference Tables

**60" Deep Tops**  
**2-Layer, Glass Tops**

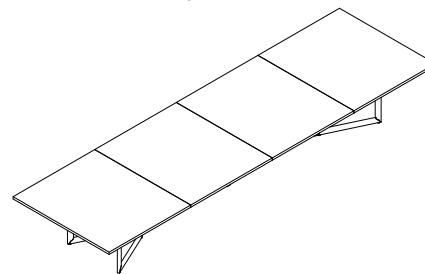

D	W	Pattern No.	GC__ Top	GE__ Top	T__ Lower Layer	HG__ Lower Layer	PM__ Edge Upcharge	AU__ Edge Upcharge	PM__ Base Upcharge
60"	120"	<b>08VOFR60120GF2</b>	\$29,447	\$30,737	\$894	\$984	\$888	\$3,195	\$2,536
60"	132"	<b>08VOFR60132GF2</b>	32,012	33,432	996	1,095	979	3,409	2,536
60"	144"	<b>08VOFR60144GF2</b>	34,578	36,127	1,058	1,164	1,033	3,622	2,536
60"	156"	<b>08VOFR60156GF2</b>	37,144	38,824	1,133	1,246	1,087	4,838	2,536
60"	168"	<b>08VOFR60168GF2</b>	35,528	41,518	1,194	1,314	1,141	4,047	2,536
60"	180"	<b>08VOFR60180GF2</b>	42,280	44,216	1,235	1,360	1,195	4,261	2,536
60"	192"	<b>08VOFR60192GF2</b>	45,732	47,796	1,345	1,481	1,249	4,475	4,204
60"	204"	<b>08VOFR60204GF2</b>	47,421	49,615	1,419	1,562	1,305	4,686	4,204
60"	216"	<b>08VOFR60216GF2</b>	49,109	51,433	1,454	1,600	1,359	4,900	4,204
60"	228"	<b>08VOFR60228GF2</b>	50,798	53,250	1,571	1,728	1,413	5,113	4,204
60"	240"	<b>08VOFR60240GF2</b>	52,484	55,065	1,645	1,811	1,468	5,325	4,204

Order Code	Specification Information	Refer To Accessories Section	Pricing Tiers
Example: <b>08VOFR60120GF2M-GE01-PM01-MC01-GM2-MC01-UCO</b>	To order please specify pattern number including:	Please refer to Accessories section, <a href="#">page 213</a> for power details.	Please refer to Materials and Finish <a href="#">page 9</a> for specification details.
<b>08</b> Highline Collection	1. Top finish	<b>Grommet options available in these finishes:</b>	T1 and T2 pricing includes powder coated base finish.
<b>VOF</b> Vector Base	2. Trim Finish (only applies if trim type is metal or leather)	Powder coated	There is an upcharge for plated base finishes as highlighted above.
<b>R</b> Rectangular	3. Base finish	Premium (Polished Chrome, Satin Nickel or Oil Rubbed Bronze)	For additional stone options and pricing please contact your sales representative."
<b>60</b> Depth	4. Grommet option	<b>Power Box Options</b>	
<b>120</b> Width	5. Grommet finish (only applies if grommets are selected)	<b>Code: Description:</b>	
<b>G</b> Glass	6. Power box option	NP No Power	
<b>F2</b> 2 Layer-Flat w/ Trim	7. Table-top power finish (only applies if table-top power is selected)	UCO Undermount	
<b>M</b> Metal Trim		ECO Edgemount	
<b>GE01</b> Top Finish	<b>Trim Type</b>	T1E Tabletop 1-Sided Lid	
<b>PM01</b> Trim Finish	N = No trim	T2C Tabletop 2-Sided Lid	
<b>MC01</b> Base Finish	M = Metal (available in Premium and Powder Coat finishes)	<b>Must select Wire Management</b>	
<b>GM2</b> Grommet Opt.	L = Leather	<b>Column and Finish:</b>	
<b>MC01</b> Grommet Finish		Powder coated	
<b>UCO</b> Undermount		Premium (Polished Chrome, Satin Nickel or Oil Rubbed Bronze)	

# Rectangular Conference Tables

**60" Deep Tops**  
**1-Layer, Corian Tops**

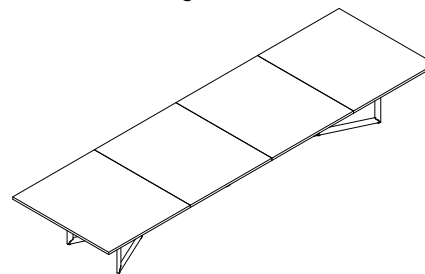

D	W	Pattern No.	CS01 Top	MC__ Edge Upcharge	PM__ Edge Upcharge	AU__ Edge Upcharge	PM__ Base Upcharge
60"	120"	<b>08VOFR60120CF1</b>	\$26,417	\$2,542	\$3,430	\$5,737	\$2,416
60"	132"	<b>08VOFR60132CF1</b>	29,082	2,785	3,764	6,194	2,416
60"	144"	<b>08VOFR60144CF1</b>	31,746	3,029	4,063	6,651	2,416
60"	156"	<b>08VOFR60156CF1</b>	34,410	3,273	4,360	8,111	2,416
60"	168"	<b>08VOFR60168CF1</b>	37,075	3,518	4,659	7,565	2,416
60"	180"	<b>08VOFR60180CF1</b>	39,736	3,763	4,958	8,023	2,416
60"	192"	<b>08VOFR60192CF1</b>	42,814	4,005	5,254	8,480	2,416
60"	204"	<b>08VOFR60204CF1</b>	44,723	3,987	5,292	8,674	4,083
60"	216"	<b>08VOFR60216CF1</b>	46,633	3,969	5,328	8,869	4,083
60"	228"	<b>08VOFR60228CF1</b>	48,542	3,952	5,365	9,065	4,083
60"	240"	<b>08VOFR60240CF1</b>	50,451	3,935	5,403	9,261	4,083

Order Code	Specification Information	Refer To Accessories Section	Pricing Tiers
Example: <b>08VOFR60120CF1M-CS01-PM01-MC01-GM2-MC01-UCO</b>	To order please specify pattern number including:	Please refer to Accessories section, <a href="#">page 213</a> for power details.	Please refer to Materials and Finish <a href="#">page 9</a> for specification details.
<b>08</b> Highline Collection	1. Top finish	<b>Grommet options available in these finishes:</b>	T1 and T2 pricing includes powder coated base finish.
<b>VOF</b> Vector Base	2. Trim Finish (only applies if trim type is metal or leather)	Powder coated	There is an upcharge for plated base finishes as highlighted above.
<b>R</b> Rectangular	3. Base finish	Premium (Polished Chrome, Satin Nickel or Oil Rubbed Bronze)	For additional stone options and pricing please contact your sales representative."
<b>60</b> Depth	4. Grommet option	<b>Power Box Options</b>	
<b>120</b> Width	5. Grommet finish (only applies if grommets are selected)	<b>Code: Description:</b>	
<b>C</b> Corian	6. Power box option	NP No Power	
<b>F1</b> 1 Layer-Flat w/ Trim	7. Table-top power finish (only applies if table-top power is selected)	UCO Undermount	
<b>M</b> Metal Trim		ECO Edgemount	
<b>CS01</b> Top Finish	<b>Trim Type</b>	T1E Tabletop 1-Sided Lid	
<b>PM01</b> Trim Finish	N = No trim	T2C Tabletop 2-Sided Lid	
<b>MC01</b> Base Finish	M = Metal (available in Premium and Powder Coat finishes)	<b>Must select Wire Management</b>	
<b>GM2</b> Grommet Opt.	L = Leather	<b>Column and Finish:</b>	
<b>MC01</b> Grommet Finish		Powder coated	
<b>UCO</b> Undermount		Premium (Polished Chrome, Satin Nickel or Oil Rubbed Bronze)	

# Rectangular Conference Tables

**60" Deep Tops**  
**2-Layer, Corian Tops**

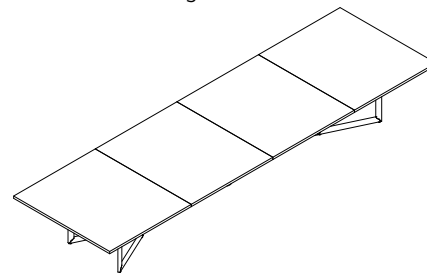

D	W	Pattern No.	CS01 Top	T__ Lower Layer	HG__ Lower Layer	PM__ Edge Upcharge	AU__ Edge Upcharge	PM__ Base Upcharge
60"	120"	<b>08VOFR60120CF2</b>	\$31,101	\$894	\$984	\$888	\$3,195	\$2,536
60"	132"	<b>08VOFR60132CF2</b>	33,847	996	1,095	979	3,409	2,536
60"	144"	<b>08VOFR60144CF2</b>	36,594	1,058	1,164	1,033	3,622	2,536
60"	156"	<b>08VOFR60156CF2</b>	39,342	1,133	1,246	1,087	4,838	2,536
60"	168"	<b>08VOFR60168CF2</b>	42,089	1,194	1,314	1,141	4,047	2,536
60"	180"	<b>08VOFR60180CF2</b>	44,839	1,235	1,360	1,195	4,261	2,536
60"	192"	<b>08VOFR60192CF2</b>	48,435	1,345	1,481	1,249	4,475	4,204
60"	204"	<b>08VOFR60204CF2</b>	50,340	1,419	1,562	1,305	4,686	4,204
60"	216"	<b>08VOFR60216CF2</b>	52,245	1,454	1,600	1,359	4,900	4,204
60"	228"	<b>08VOFR60228CF2</b>	54,151	1,571	1,728	1,413	5,113	4,204
60"	240"	<b>08VOFR60240CF2</b>	56,053	1,645	1,811	1,468	5,325	4,204

Order Code	Specification Information	Refer To Accessories Section	Pricing Tiers
Example: <b>08VOFR60120CF2M-CS01-PM01-MC01-GM2-MC01-UCO</b>	To order please specify pattern number including:	Please refer to Accessories section, <b>page 213</b> for power details.	Please refer to Materials and Finish <b>page 9</b> for specification details.
<b>08</b> Highline Collection	1. Top finish	<b>Grommet options available in these finishes:</b>	T1 and T2 pricing includes powder coated base finish.
<b>VOF</b> Vector Base	2. Trim Finish (only applies if trim type is metal or leather)	Powder coated	There is an upcharge for plated base finishes as highlighted above.
<b>R</b> Rectangular	3. Base finish	Premium (Polished Chrome, Satin Nickel or Oil Rubbed Bronze)	For additional stone options and pricing please contact your sales representative."
<b>60</b> Depth	4. Grommet option	<b>Power Box Options</b>	
<b>120</b> Width	5. Grommet finish (only applies if grommets are selected)	<b>Code: Description:</b>	
<b>C</b> Corian	6. Power box option	NP No Power	
<b>F2</b> 2 Layer-Flat w/ Trim	7. Table-top power finish (only applies if table-top power is selected)	UCO Undermount	
<b>M</b> Metal Trim		ECO Edgemount	
<b>CS01</b> Top Finish	<b>Trim Type</b>	T1E Tabletop 1-Sided Lid	
<b>PM01</b> Trim Finish	N = No trim	T2C Tabletop 2-Sided Lid	
<b>MC01</b> Base Finish	M = Metal (available in Premium and Powder Coat finishes)	<b>Must select Wire Management Column and Finish:</b>	
<b>GM2</b> Grommet Opt.	L = Leather	Powder coated	
<b>MC01</b> Grommet Finish		Premium (Polished Chrome, Satin Nickel or Oil Rubbed Bronze)	
<b>UCO</b> Undermount			

# Highline Vector Conference Tables

## 72" Deep Conference Tables

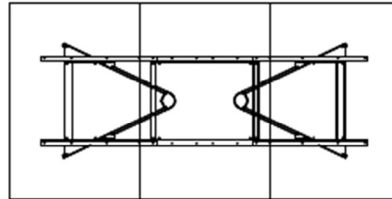
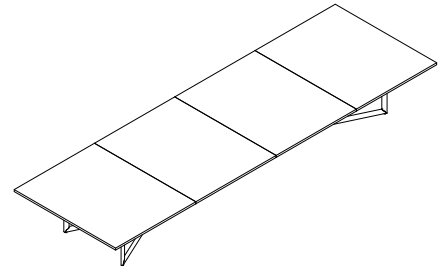

**144L**  
SEATS 12

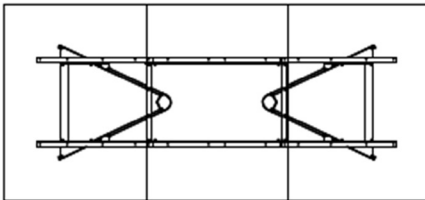

**156L**  
SEATS 12

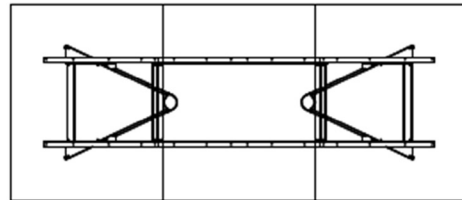

**168L**  
SEATS 14

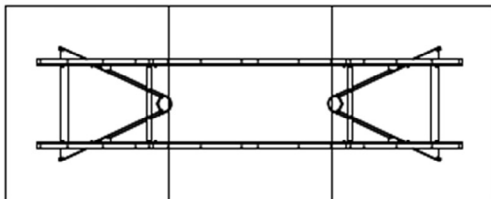

**180L**  
SEATS 16

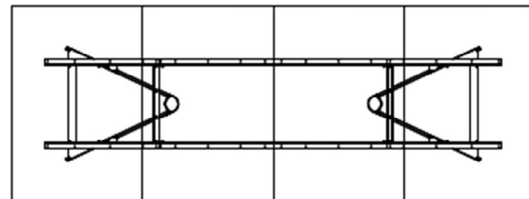

**192L**  
SEATS 16

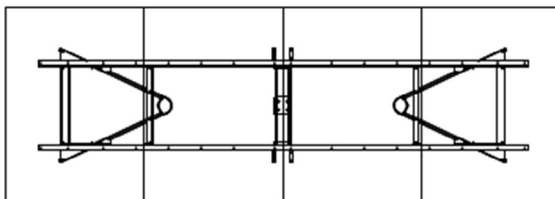

**204L**  
SEATS 16

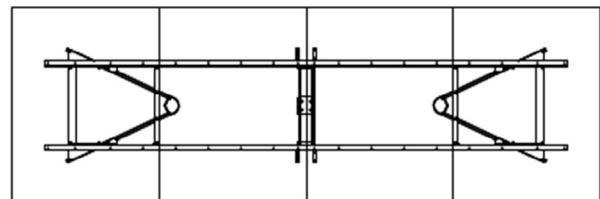

**216L**  
SEATS 18

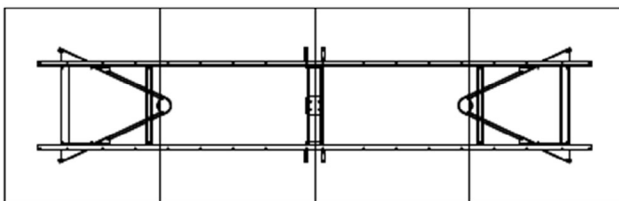

**228L**  
SEATS 18

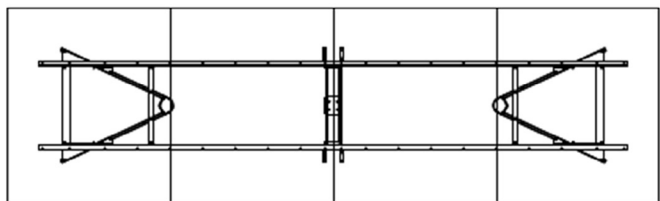

**240L**  
SEATS 20

# Highline Vector Conference Tables

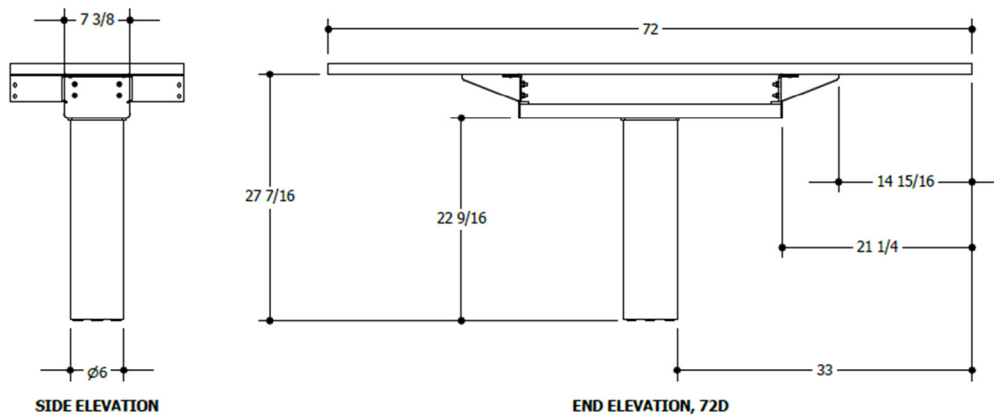
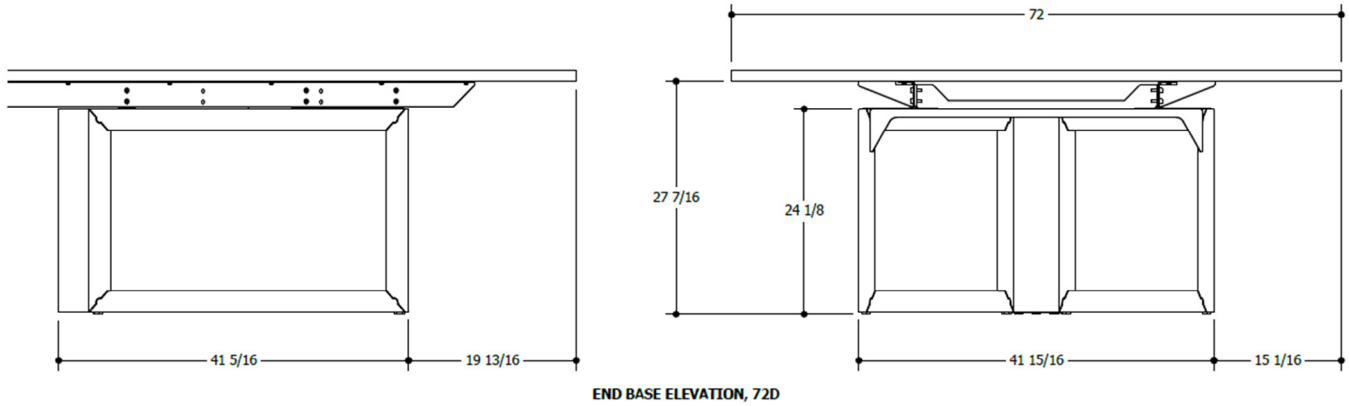
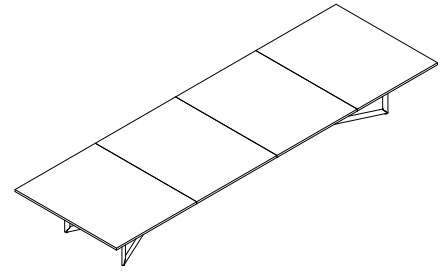

# Rectangular Conference Tables

**72" Deep Tops**  
**1-Layer, Veneer Tops**

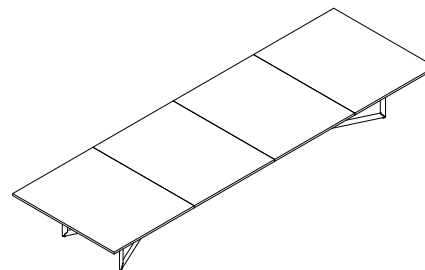

D	W	Pattern No.	T1__ Top	T2__ Top	MC__ Edge Upcharge	PM__ Edge Upcharge	AU__ Edge Upcharge	PM__ Base Upcharge
72"	144"	<b>08VOFR72144VF1</b>	\$26,276	\$28,327	\$4,677	\$5,764	\$3,835	\$2,777
72"	156"	<b>08VOFR72156VF1</b>	27,473	29,695	4,745	5,886	4,047	2,777
72"	168"	<b>08VOFR72168VF1</b>	28,670	31,064	4,814	6,009	4,261	2,777
72"	180"	<b>08VOFR72180VF1</b>	29,869	32,432	4,881	6,131	4,475	2,777
72"	192"	<b>08VOFR72192VF1</b>	31,067	33,803	4,950	6,255	4,686	2,777
72"	204"	<b>08VOFR72204VF1</b>	33,479	36,385	4,972	6,331	4,900	4,444
72"	216"	<b>08VOFR72216VF1</b>	34,677	37,753	4,960	6,373	5,113	4,444
72"	228"	<b>08VOFR72228VF1</b>	35,874	39,122	4,948	6,415	5,325	4,444
72"	240"	<b>08VOFR72240VF1</b>	37,072	40,491	4,934	6,455	5,539	4,444

Order Code	Specification Information	Refer To Accessories Section	Pricing Tiers
Example: <b>08VOFR72144VF1M-T003-PM01-MC01-GM2-MC01-UC0</b>	To order please specify pattern number including:	Please refer to Accessories section, <a href="#">page 213</a> for power details.	Please refer to Materials and Finish <a href="#">page 9</a> for specification details.
<b>08</b> Highline Collection	1. Top finish	<b>Grommet options available in these finishes:</b>	T1 and T2 pricing includes powder coated base finish.
<b>VOF</b> Vector Base	2. Trim Finish (only applies if trim type is metal or leather)	Powder coated	There is an upcharge for plated base finishes as highlighted above.
<b>R</b> Rectangular	3. Base finish	Premium (Polished Chrome, Satin Nickel or Oil Rubbed Bronze)	For additional stone options and pricing please contact your sales representative."
<b>72</b> Depth	4. Grommet option	<b>Power Box Options</b>	
<b>144</b> Width	5. Grommet finish (only applies if grommets are selected)	<b>Code: Description:</b>	
<b>V</b> Veneer	6. Power box option	NP No Power	
<b>F1</b> 1 Layer-Flat w/ Trim	7. Table-top power finish (only applies if table-top power is selected)	UC0 Undermount	
<b>M</b> Metal Trim		ECO Edgemount	
<b>T003</b> Top Finish	<b>Trim Type</b>	T1E Tabletop 1-Sided Lid	
<b>PM01</b> Trim Finish	N = No trim	T2C Tabletop 2-Sided Lid	
<b>MC01</b> Base Finish	M = Metal (available in Premium and Powder Coat finishes)	<b>Must select Wire Management Column and Finish:</b>	
<b>GM2</b> Grommet Opt.	L = Leather	Powder coated	
<b>MC01</b> Grommet Finish		Premium (Polished Chrome, Satin Nickel or Oil Rubbed Bronze)	
<b>UC0</b> Undermount			



# Rectangular Conference Tables

**72" Deep Tops**  
**2-Layer, Veneer Tops**

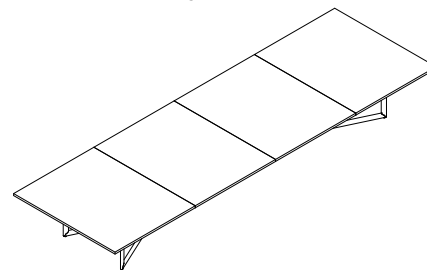

D	W	Pattern No.	T1__ Top	T2__ Top	T__ Lower Layer	HG__ Lower Layer	PM__ Edge Upcharge	AU__ Edge Upcharge	PM__ Base Upcharge
72"	144"	<b>08VOFR72144VF2</b>	\$31,852	\$33,904	\$1,090	\$1,200	\$1,087	\$3,835	\$2,777
72"	156"	<b>08VOFR72156VF2</b>	33,094	35,316	1,248	1,373	1,141	4,047	2,777
72"	168"	<b>08VOFR72168VF2</b>	34,334	36,728	1,345	1,481	1,195	4,261	2,777
72"	180"	<b>08VOFR72180VF2</b>	35,575	38,140	1,428	1,571	1,249	4,475	2,777
72"	192"	<b>08VOFR72192VF2</b>	36,814	39,549	1,507	1,659	1,305	4,686	2,777
72"	204"	<b>08VOFR72204VF2</b>	39,608	42,513	1,591	1,750	1,359	4,900	4,444
72"	216"	<b>08VOFR72216VF2</b>	40,818	43,895	1,672	1,839	1,413	5,113	4,444
72"	228"	<b>08VOFR72228VF2</b>	42,030	45,278	1,748	1,923	1,468	5,325	4,444
72"	240"	<b>08VOFR72240VF2</b>	43,241	46,659	1,835	2,021	1,521	5,539	4,444

Order Code	Specification Information	Refer To Accessories Section	Pricing Tiers
Example: <b>08VOFR72144VF2M-T003-PM01-MC01-GM2-MC01-UCO</b>	To order please specify pattern number including:	Please refer to Accessories section, <a href="#">page 213</a> for power details.	Please refer to Materials and Finish <a href="#">page 9</a> for specification details.
<b>08</b> Highline Collection	1. Top finish	<b>Grommet options available in these finishes:</b>	T1 and T2 pricing includes powder coated base finish.
<b>VOF</b> Vector Base	2. Trim Finish (only applies if trim type is metal or leather)	Powder coated	There is an upcharge for plated base finishes as highlighted above.
<b>R</b> Rectangular	3. Base finish	Premium (Polished Chrome, Satin Nickel or Oil Rubbed Bronze)	For additional stone options and pricing please contact your sales representative."
<b>72</b> Depth	4. Grommet option	<b>Power Box Options</b>	
<b>144</b> Width	5. Grommet finish (only applies if grommets are selected)	<b>Code: Description:</b>	
<b>V</b> Veneer	6. Power box option	NP No Power	
<b>F2</b> 2 Layer-Flat w/ Trim	7. Table-top power finish (only applies if table-top power is selected)	UCO Undermount	
<b>M</b> Metal Trim		ECO Edgemount	
<b>T003</b> Top Finish	<b>Trim Type</b>	TIE Tabletop 1-Sided Lid	
<b>PM01</b> Trim Finish	N = No trim	T2C Tabletop 2-Sided Lid	
<b>MC01</b> Base Finish	M = Metal (available in Premium and Powder Coat finishes)	<b>Must select Wire Management Column and Finish:</b>	
<b>GM2</b> Grommet Opt.	L = Leather	Powder coated	
<b>MC01</b> Grommet Finish		Premium (Polished Chrome, Satin Nickel or Oil Rubbed Bronze)	
<b>UCO</b> Undermount			

# Rectangular Conference Tables

**72" Deep Tops**  
**Slab Top, Veneer Tops**

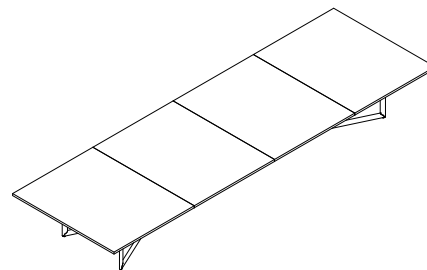

D	W	Pattern No.	T1__ Top	T2__ Top	MC__ Edge Upcharge	PM__ Edge Upcharge	AU__ Edge Upcharge	PM__ Base Upcharge
72"	144"	<b>08VOFR72144VSF</b>	\$27,175	\$29,227	\$4,677	\$5,764	\$8,512	\$2,777
72"	156"	<b>08VOFR72156VSF</b>	28,348	30,571	4,746	5,887	8,793	2,777
72"	168"	<b>08VOFR72168VSF</b>	29,522	31,914	4,813	6,008	9,073	2,777
72"	180"	<b>08VOFR72180VSF</b>	30,694	33,259	4,881	6,131	9,356	2,777
72"	192"	<b>08VOFR72192VSF</b>	31,865	34,600	4,950	6,255	9,636	2,777
72"	204"	<b>08VOFR72204VSF</b>	34,634	37,540	4,974	6,333	9,874	4,444
72"	216"	<b>08VOFR72216VSF</b>	35,859	38,934	4,960	6,373	10,073	4,444
72"	228"	<b>08VOFR72228VSF</b>	37,081	40,329	4,949	6,416	10,274	4,444
72"	240"	<b>08VOFR72240VSF</b>	38,305	41,723	4,935	6,456	10,475	4,444

Order Code	Specification Information	Refer To Accessories Section	Pricing Tiers
Example: <b>08VOFR72144VSFM-T003-PM01-MC01-GM2-MC01-UCO</b>	To order please specify pattern number including:	Please refer to Accessories section, <a href="#">page 213</a> for power details.	Please refer to Materials and Finish <a href="#">page 9</a> for specification details.
<b>08</b> Highline Collection	1. Top finish	<b>Grommet options available in these finishes:</b>	T1 and T2 pricing includes powder coated base finish.
<b>VOF</b> Vector Base	2. Trim Finish (only applies if trim type is metal or leather)	Powder coated	There is an upcharge for plated base finishes as highlighted above.
<b>R</b> Rectangular	3. Base finish	Premium (Polished Chrome, Satin Nickel or Oil Rubbed Bronze)	For additional stone options and pricing please contact your sales representative."
<b>42</b> Depth	4. Grommet option	<b>Power Box Options</b>	
<b>84</b> Width	5. Grommet finish (only applies if grommets are selected)	<b>Code: Description:</b>	
<b>V</b> Veneer	6. Power box option	NP No Power	
<b>SF</b> Slab	7. Table-top power finish (only applies if table-top power is selected)	UCO Undermount	
<b>M</b> Metal Trim		ECO Edgemount	
<b>T003</b> Top Finish	<b>Trim Type</b>	T1E Tabletop 1-Sided Lid	
<b>PM01</b> Trim Finish	N = No trim	T2C Tabletop 2-Sided Lid	
<b>MC01</b> Base Finish	M = Metal (available in Premium and Powder Coat finishes)	<b>Must select Wire Management Column and Finish:</b>	
<b>GM2</b> Grommet Opt.	L = Leather	Powder coated	
<b>MC01</b> Grommet Finish		Premium (Polished Chrome, Satin Nickel or Oil Rubbed Bronze)	
<b>UCO</b> Undermount			



# Rectangular Conference Tables

**72" Deep Tops**  
**1-Layer, Glass Tops**

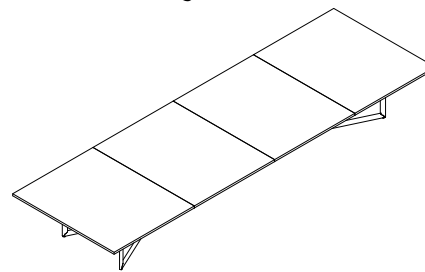

D	W	Pattern No.	GC__ Top	GE__ Top	PM__ Edge Upcharge	AU__ Edge Upcharge	PM__ Base Upcharge
72"	144"	<b>08VOFR72144GF1</b>	\$41,462	\$43,320	\$1,087	\$3,835	\$2,777
72"	156"	<b>08VOFR72156GF1</b>	43,548	45,561	1,141	4,047	2,777
72"	168"	<b>08VOFR72168GF1</b>	45,634	47,803	1,195	4,261	2,777
72"	180"	<b>08VOFR72180GF1</b>	47,720	50,042	1,249	4,475	2,777
72"	192"	<b>08VOFR72192GF1</b>	49,807	52,285	1,305	4,686	2,777
72"	204"	<b>08VOFR72204GF1</b>	53,112	55,746	1,359	4,900	4,444
72"	216"	<b>08VOFR72216GF1</b>	55,114	58,018	1,413	5,113	4,444
72"	228"	<b>08VOFR72228GF1</b>	57,116	60,060	1,468	5,325	4,444
72"	240"	<b>08VOFR72240GF1</b>	59,117	62,216	1,521	5,539	4,444

Order Code	Specification Information	Refer To Accessories Section	Pricing Tiers
Example: <b>08VOFR72144GF1M-GE01-PM01-MC01-GM2-MC01-UC0</b>	To order please specify pattern number including:	Please refer to Accessories section, <a href="#">page 213</a> for power details.	Please refer to Materials and Finish <a href="#">page 9</a> for specification details.
<b>08</b> Highline Collection	1. Top finish	<b>Grommet options available in these finishes:</b>	T1 and T2 pricing includes powder coated base finish.
<b>VOF</b> Vector Base	2. Trim Finish (only applies if trim type is metal or leather)	Powder coated	There is an upcharge for plated base finishes as highlighted above.
<b>R</b> Rectangular	3. Base finish	Premium (Polished Chrome, Satin Nickel or Oil Rubbed Bronze)	For additional stone options and pricing please contact your sales representative."
<b>72</b> Depth	4. Grommet option	<b>Power Box Options</b>	
<b>144</b> Width	5. Grommet finish (only applies if grommets are selected)	<b>Code: Description:</b>	
<b>G</b> Glass	6. Power box option	NP No Power	
<b>F1</b> 1 Layer-Flat w/ Trim	7. Table-top power finish (only applies if table-top power is selected)	UC0 Undermount	
<b>M</b> Metal Trim		ECO Edgemount	
<b>GE01</b> Top Finish	<b>Trim Type</b>	T1E Tabletop 1-Sided Lid	
<b>PM01</b> Trim Finish	N = No trim	T2C Tabletop 2-Sided Lid	
<b>MC01</b> Base Finish	M = Metal (available in Premium and Powder Coat finishes)	<b>Must select Wire Management</b>	
<b>GM2</b> Grommet Opt.	L = Leather	<b>Column and Finish:</b>	
<b>MC01</b> Grommet Finish		Powder coated	
<b>UC0</b> Undermount		Premium (Polished Chrome, Satin Nickel or Oil Rubbed Bronze)	

# Rectangular Conference Tables

**72" Deep Tops**  
**2-Layer, Glass Tops**

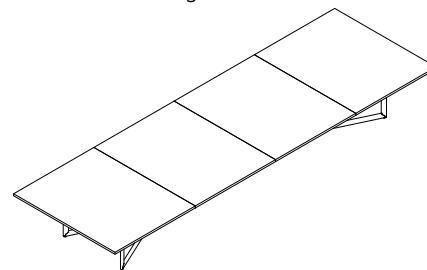

D	W	Pattern No.	GC__ Top	GE__ Top	T__ Lower Layer	HG__ Lower Layer	PM__ Edge Upcharge	AU__ Edge Upcharge	PM__ Base Upcharge
72"	144"	<b>08VOFR72144GF2</b>	\$42,400	\$44,259	\$1,090	\$1,200	\$1,087	\$3,835	\$2,777
72"	156"	<b>08VOFR72156GF2</b>	44,460	46,474	1,248	1,373	1,141	4,047	2,777
72"	168"	<b>08VOFR72168GF2</b>	46,520	48,689	1,345	1,481	1,195	4,261	2,777
72"	180"	<b>08VOFR72180GF2</b>	48,582	50,905	1,428	1,571	1,249	4,475	2,777
72"	192"	<b>08VOFR72192GF2</b>	50,638	53,116	1,507	1,659	1,305	4,686	2,777
72"	204"	<b>08VOFR72204GF2</b>	54,317	56,949	1,591	1,750	1,359	4,900	4,444
72"	216"	<b>08VOFR72216GF2</b>	56,345	59,250	1,672	1,839	1,413	5,113	4,444
72"	228"	<b>08VOFR72228GF2</b>	58,375	61,318	1,748	1,923	1,468	5,325	4,444
72"	240"	<b>08VOFR72240GF2</b>	60,403	63,502	1,835	2,021	1,521	5,539	4,444

Order Code	Specification Information	Refer To Accessories Section	Pricing Tiers
Example: <b>08VOFR72144GF2M-GE01-PM01-MC01-GM2-MC01-UCO</b>	To order please specify pattern number including:	Please refer to Accessories section, <a href="#">page 213</a> for power details.	Please refer to Materials and Finish <a href="#">page 9</a> for specification details.
<b>08</b> Highline Collection	1. Top finish	<b>Grommet options available in these finishes:</b>	T1 and T2 pricing includes powder coated base finish.
<b>VOF</b> Vector Base	2. Trim Finish (only applies if trim type is metal or leather)	Powder coated	There is an upcharge for plated base finishes as highlighted above.
<b>R</b> Rectangular	3. Base finish	Premium (Polished Chrome, Satin Nickel or Oil Rubbed Bronze)	For additional stone options and pricing please contact your sales representative."
<b>72</b> Depth	4. Grommet option	<b>Power Box Options</b>	
<b>144</b> Width	5. Grommet finish (only applies if grommets are selected)	<b>Code: Description:</b>	
<b>G</b> Glass	6. Power box option	NP No Power	
<b>F2</b> 2 Layer-Flat w/ Trim	7. Table-top power finish (only applies if table-top power is selected)	UCO Undermount	
<b>M</b> Metal Trim		ECO Edgemount	
<b>GE01</b> Top Finish	<b>Trim Type</b>	T1E Tabletop 1-Sided Lid	
<b>PM01</b> Trim Finish	N = No trim	T2C Tabletop 2-Sided Lid	
<b>MC01</b> Base Finish	M = Metal (available in Premium and Powder Coat finishes)	<b>Must select Wire Management</b>	
<b>GM2</b> Grommet Opt.	L = Leather	<b>Column and Finish:</b>	
<b>MC01</b> Grommet Finish		Powder coated	
<b>UCO</b> Undermount		Premium (Polished Chrome, Satin Nickel or Oil Rubbed Bronze)	

# Rectangular Conference Tables

**72" Deep Tops**  
**1-Layer, Corian Tops**

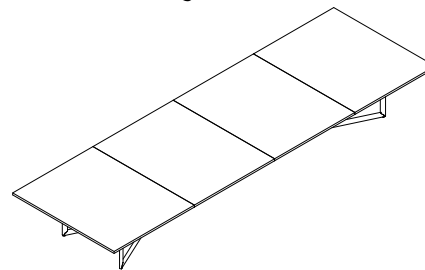

D	W	Pattern No.	CS01 Top	MC__ Edge Upcharge	PM__ Edge Upcharge	AU__ Edge Upcharge	PM__ Base Upcharge
72"	144"	<b>08VOFR72144CF1</b>	\$39,206	\$4,677	\$5,764	\$8,512	\$2,777
72"	156"	<b>08VOFR72156CF1</b>	41,482	4,744	5,885	8,791	2,777
72"	168"	<b>08VOFR72168CF1</b>	43,756	4,814	6,009	9,075	2,777
72"	180"	<b>08VOFR72180CF1</b>	46,031	4,881	6,131	9,356	2,777
72"	192"	<b>08VOFR72192CF1</b>	48,308	4,950	6,255	9,636	2,777
72"	204"	<b>08VOFR72204CF1</b>	51,797	4,973	6,332	9,873	4,444
72"	216"	<b>08VOFR72216CF1</b>	54,073	4,960	6,373	10,073	4,444
72"	228"	<b>08VOFR72228CF1</b>	56,348	4,948	6,415	10,273	4,444
72"	240"	<b>08VOFR72240CF1</b>	58,747	4,934	6,455	10,473	4,444

Order Code	Specification Information	Refer To Accessories Section	Pricing Tiers
Example: <b>08VOFR72144CF1M-CS01-PM01-MC01-GM2-MC01-UCO</b>	To order please specify pattern number including:	Please refer to Accessories section, <a href="#">page 213</a> for power details.	Please refer to Materials and Finish <a href="#">page 9</a> for specification details.
<b>08</b> Highline Collection	1. Top finish	<b>Grommet options available in these finishes:</b>	T1 and T2 pricing includes powder coated base finish.
<b>VOF</b> Vector Base	2. Trim Finish (only applies if trim type is metal or leather)	Powder coated	There is an upcharge for plated base finishes as highlighted above.
<b>R</b> Rectangular	3. Base finish	Premium (Polished Chrome, Satin Nickel or Oil Rubbed Bronze)	For additional stone options and pricing please contact your sales representative."
<b>72</b> Depth	4. Grommet option	<b>Power Box Options</b>	
<b>144</b> Width	5. Grommet finish (only applies if grommets are selected)	<b>Code: Description:</b>	
<b>C</b> Corian	6. Power box option	NP No Power	
<b>F1</b> 1 Layer-Flat w/ Trim	7. Table-top power finish (only applies if table-top power is selected)	UCO Undermount	
<b>M</b> Metal Trim		ECO Edgemount	
<b>CS01</b> Top Finish	<b>Trim Type</b>	T1E Tabletop 1-Sided Lid	
<b>PM01</b> Trim Finish	N = No trim	T2C Tabletop 2-Sided Lid	
<b>MC01</b> Base Finish	M = Metal (available in Premium and Powder Coat finishes)	<b>Must select Wire Management Column and Finish:</b>	
<b>GM2</b> Grommet Opt.	L = Leather	Powder coated	
<b>MC01</b> Grommet Finish		Premium (Polished Chrome, Satin Nickel or Oil Rubbed Bronze)	
<b>UCO</b> Undermount			

# Rectangular Conference Tables

**72" Deep Tops**  
**2-Layer, Corian Tops**

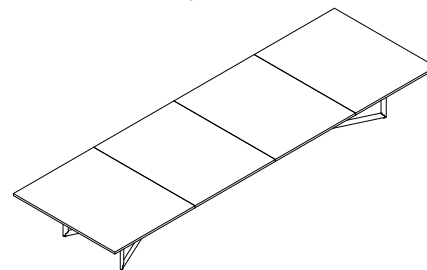

D	W	Pattern No.	CS01 Top	T__ Lower Layer	HG__ Lower Layer	PM__ Edge Upcharge	AU__ Edge Upcharge	PM__ Base Upcharge
72"	144"	<b>08VOFR72144CF2</b>	\$44,784	\$1,090	\$1,200	\$1,087	\$3,835	\$2,777
72"	156"	<b>08VOFR72156CF2</b>	47,101	1,248	1,373	1,141	4,047	2,777
72"	168"	<b>08VOFR72168CF2</b>	49,420	1,345	1,481	1,195	4,261	2,777
72"	180"	<b>08VOFR72180CF2</b>	51,739	1,428	1,571	1,249	4,475	2,777
72"	192"	<b>08VOFR72192CF2</b>	54,055	1,507	1,659	1,305	4,686	2,777
72"	204"	<b>08VOFR72204CF2</b>	57,925	1,591	1,750	1,359	4,900	4,444
72"	216"	<b>08VOFR72216CF2</b>	60,215	1,672	1,839	1,413	5,113	4,444
72"	228"	<b>08VOFR72228CF2</b>	62,503	1,748	1,923	1,468	5,325	4,444
72"	240"	<b>08VOFR72240CF2</b>	64,915	1,835	2,021	1,521	5,539	4,444

Order Code	Specification Information	Refer To Accessories Section	Pricing Tiers
Example: <b>08VOFR72144CF2M-CS01-PM01-MC01-GM2-MC01-UCO</b>	To order please specify pattern number including:	Please refer to Accessories section, <a href="#">page 213</a> for power details.	Please refer to Materials and Finish <a href="#">page 9</a> for specification details.
<b>08</b> Highline Collection	1. Top finish	<b>Grommet options available in these finishes:</b>	T1 and T2 pricing includes powder coated base finish.
<b>VOF</b> Vector Base	2. Trim Finish (only applies if trim type is metal or leather)	Powder coated	There is an upcharge for plated base finishes as highlighted above.
<b>R</b> Rectangular	3. Base finish	Premium (Polished Chrome, Satin Nickel or Oil Rubbed Bronze)	For additional stone options and pricing please contact your sales representative."
<b>72</b> Depth	4. Grommet option	<b>Power Box Options</b>	
<b>144</b> Width	5. Grommet finish (only applies if grommets are selected)	<b>Code: Description:</b>	
<b>C</b> Corian	6. Power box option	NP No Power	
<b>F2</b> 2 Layer-Flat w/ Trim	7. Table-top power finish (only applies if table-top power is selected)	UCO Undermount	
<b>M</b> Metal Trim		ECO Edgemount	
<b>CS01</b> Top Finish	<b>Trim Type</b>	T1E Tabletop 1-Sided Lid	
<b>PM01</b> Trim Finish	N = No trim	T2C Tabletop 2-Sided Lid	
<b>MC01</b> Base Finish	M = Metal (available in Premium and Powder Coat finishes)	<b>Must select Wire Management</b>	
<b>GM2</b> Grommet Opt.	L = Leather	<b>Column and Finish:</b>	
<b>MC01</b> Grommet Finish		Powder coated	
<b>UCO</b> Undermount		Premium (Polished Chrome, Satin Nickel or Oil Rubbed Bronze)	

# Accessories



Power & Connectivity  
Undermount Power  
For All Conference & Meeting Tables

Pattern No.	Description	LIST
UC0H	Undermount Hardwire QTY 1	\$1,874
UC0P	Undermount Plug In QTY 1	\$1,874
UC0A	Undermount Linkable Hardwire QTY 1	\$1,874
UC0B	Undermount Linkable Plug In QTY 1	\$1,874

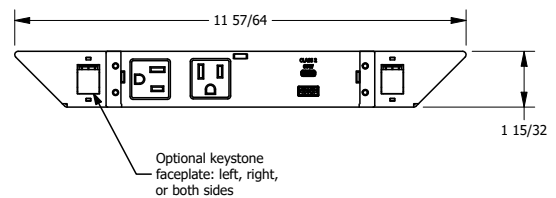
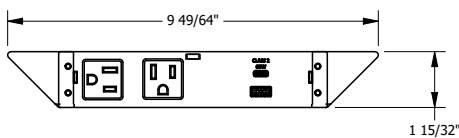
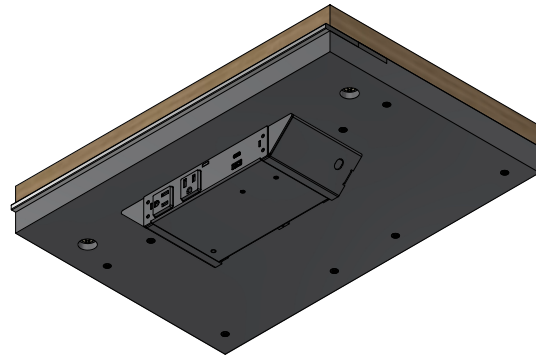
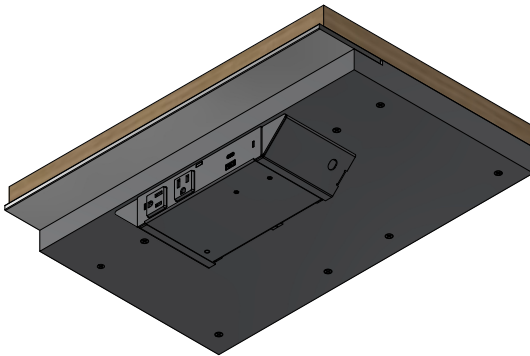
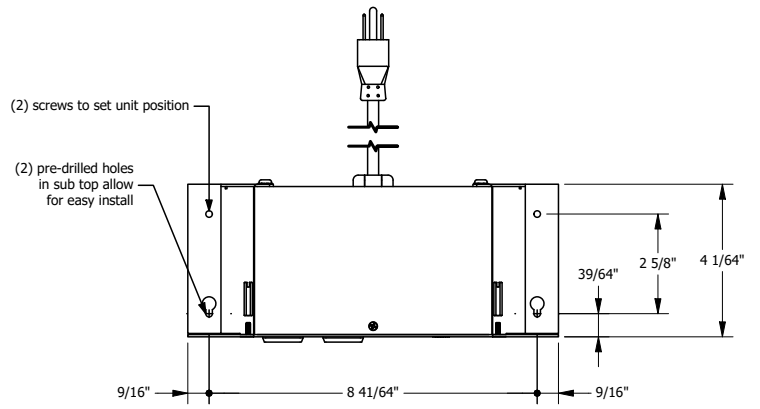
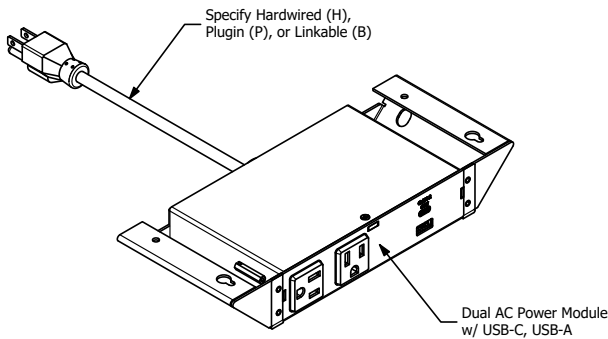

- Interior: Black powder coat
- Standard with Dual AC Power Module w/ USB-C, USB-A - specify hardwired (H), plugin (P), or linkable (B), and 2 blank end faces. (as shown above)
- For additional connectivity, please contact sale rep.

Shown above as a custom solution with (2) keystone cutouts

Power & Connectivity

Edgemount Power

For Highline Conference & Meeting Tables  
and Highline Vector 1-Layer Tops

Pattern No.	Description	LIST
ECOH	Edgemount Hardwire QTY 1	\$1,707
ECOP	Edgemount Plug In QTY 1	\$1,707
ECOA	Edgemount Linkable Hardwire QTY 1	\$1,707
ECOB	Edgemount Linkable Plug In QTY 1	\$1,707

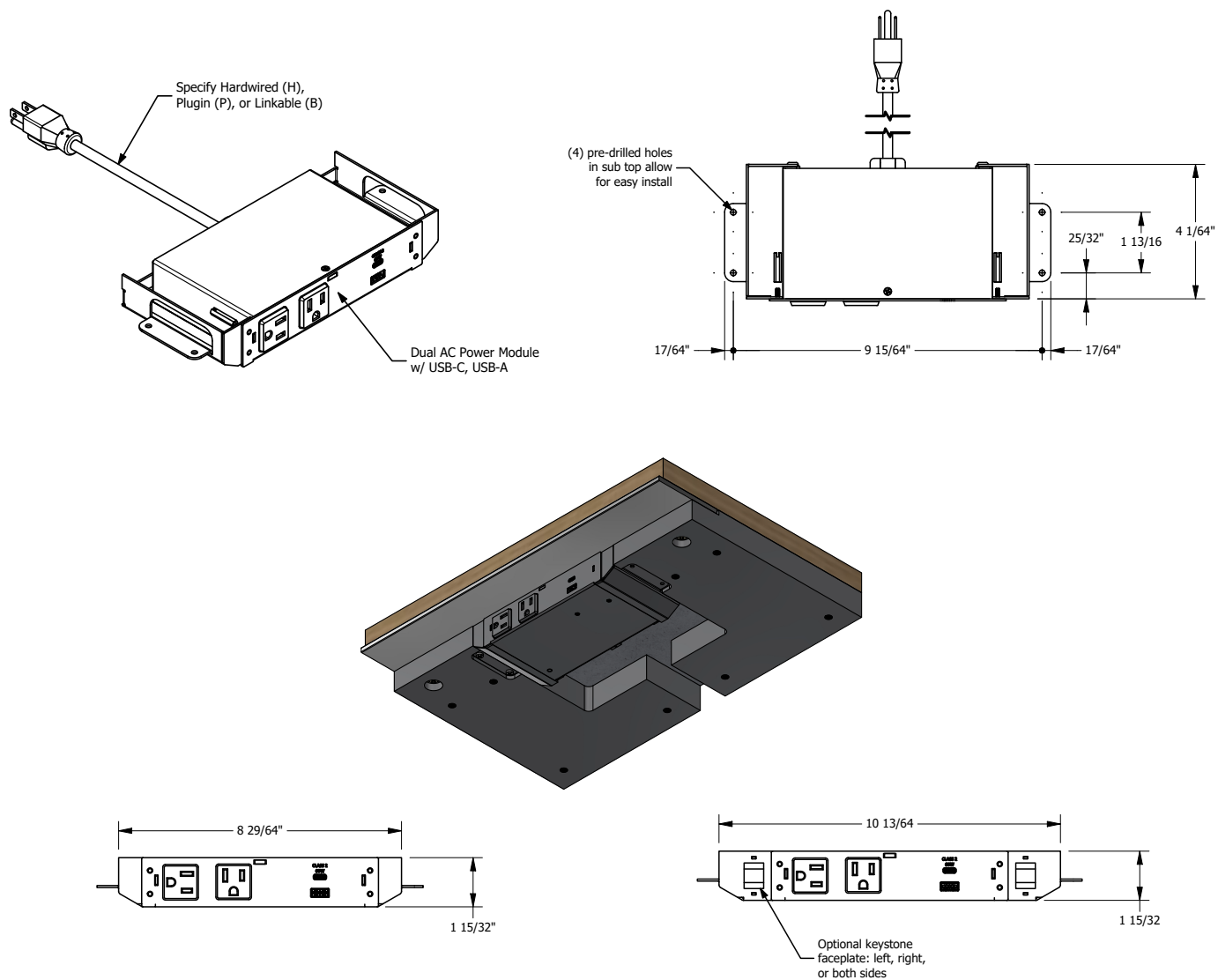

- Interior: Black powder coat
- Standard with Dual AC Power Module w/ USB-C, USB-A - specify hardwired (H), plugin (P), or linkable (B), and 2 blank end faces. (as shown above)
- For additional connectivity, please contact sale rep.

Shown above as a custom solution with (2) keystone cutouts

Power & Connectivity

Table Top Power Box

For Highline and Highline Fifty

Conference Tables

Pattern No.	Description	LIST
T1EH	Table Top Metal/Wood Lid Hardwire QTY 1	\$3,434
T1EP	Table Top Metal/Wood Lid Plug In QTY 1	\$3,434
T1EA	Table Top Metal/Wood Lid Linkable Hardwire QTY 1	\$3,434
T1EB	Table Top Metal/Wood Lid Linkable Plug In QTY 1	\$3,434

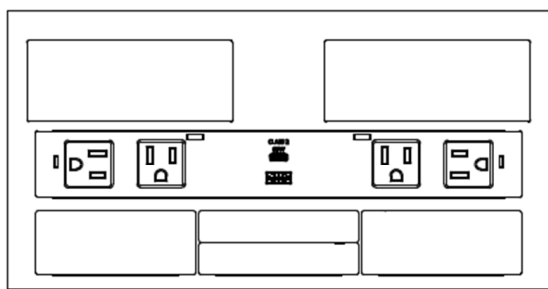
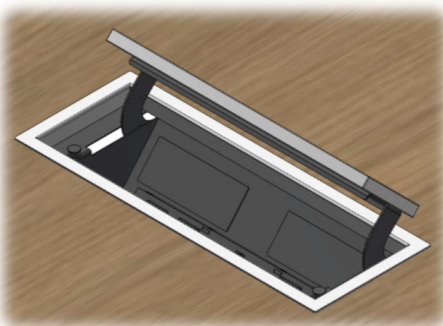
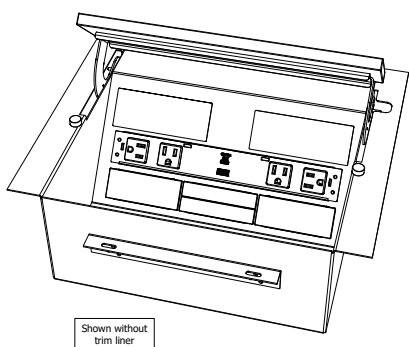

Single-Sided Conference Table Topmount

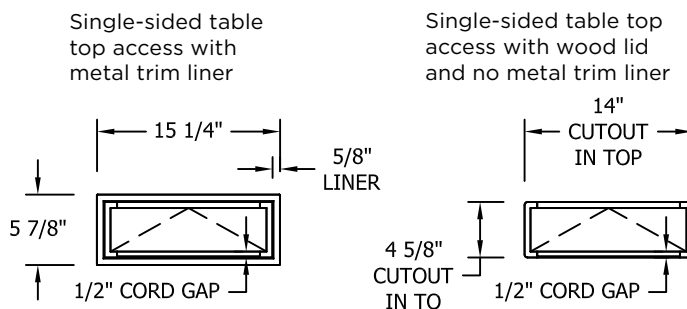

- Interior: Black powder coat metallic finish (MC12)
- Used in all conference tables
- Provided with:
  - (1) Quad AC power module w/ USB-C, USB-A - specify hardwired (H), plugin (P), or linkable (B),
  - (2) single and (2) double space blank plates
  - (2) retractor cutouts with blanks - 1, 2, or 3 knockout plates available
- For additional connectivity, replace double and single space blanks with single or double space AAP plates as desired.
- Designed to accommodate Extron Series 2 retractors.
- For more information contact customer service.

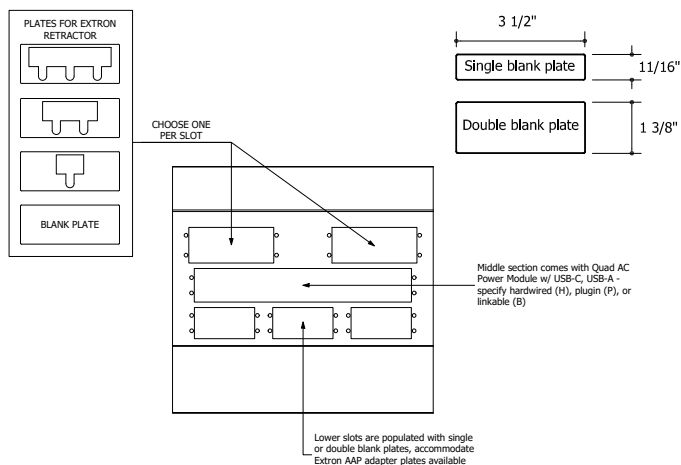

Power & Connectivity

Power Drawer

For Highline Fifty Conference and Meeting Tables  
and Highline Vector 2-Layer Tops

Pattern No.	Description	LIST
DC0H	Power Drawer Hardwire QTY 1	\$2,870
DC0P	Power Drawer Plug In QTY 1	\$2,870
DC0A	Power Drawer Linkable Hardwire QTY 1	\$2,870
DC0B	Power Drawer Linkable Plug In QTY 1	\$2,870

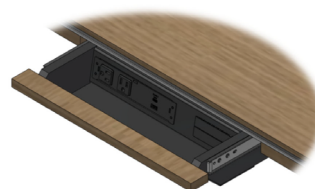
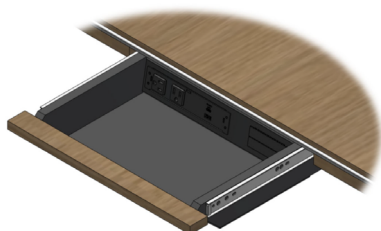
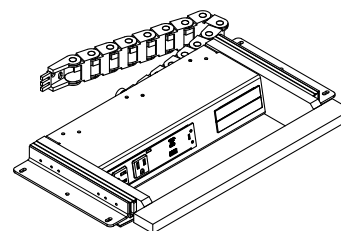
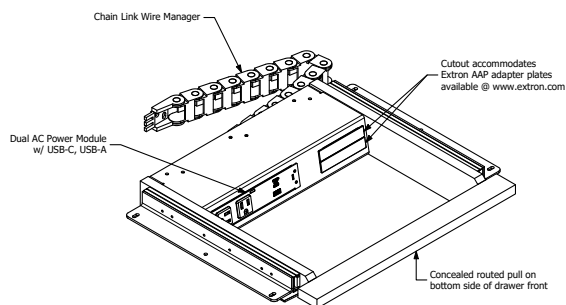

Large Power Drawer

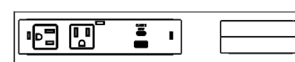

Small Power Drawer

Large Drawer

- 6 1/2" deep x 12 3/4" wide flat storage with 2 1/2" interior height
- 3/8" gap above drawer for cord exit
- Concealed routed finger pull under front
- Used at table ends
- Used along the length of 60" / 72" deep tables
- Interior drawer finish: Black powder coat metallic (MC12)
- Drawer front matches lower layer finish
- Standard with Dual AC Power Module w/ USB-C, USB-A - specify hardwired (H), plugin (P), or linkable (B), and 2 blank end faces. (as shown above)

Small Drawer

- 1 7/8" deep x 12 3/4" wide flat storage with 2 1/2" interior height
- 3/8" gap above drawer for cord exit
- Concealed routed finger pull under front
- Used along the length of 48" / 54" deep tables
- Interior drawer finish: Black powder coat metallic (MC12)
- Drawer front matches lower layer finish
- Standard with Dual AC Power Module w/ USB-C, USB-A - specify hardwired (H), plugin (P), or linkable (B), and 2 blank end faces. (as shown above)

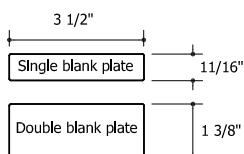

Power & Connectivity  
Table Top Power Box  
For Meeting Tables

Pattern No.	Description	LIST
T1CH	Meeting Table Top Metal/Wood Lid Hardwire QTY 1	\$3,034
T1CP	Meeting Table Top Metal/Wood Lid Plug In QTY 1	\$3,034
T1CA	Meeting Table Top Metal/Wood Lid Linkable Hardwire QTY 1	\$3,034
T1CB	Meeting Table Top Metal/Wood Lid Linkable Plug In QTY 1	\$3,034

Double-sided table top access with metal trim liner

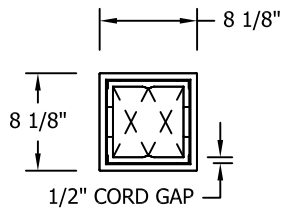

Double-sided table top access with wood lid and no metal trim liner

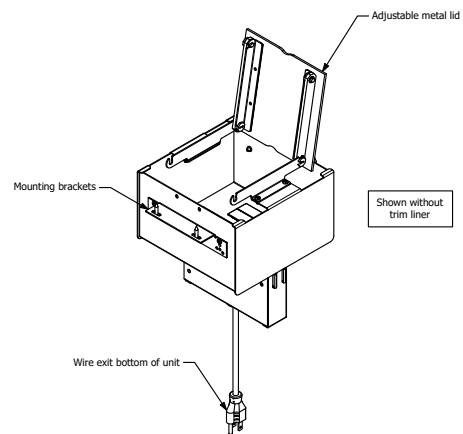
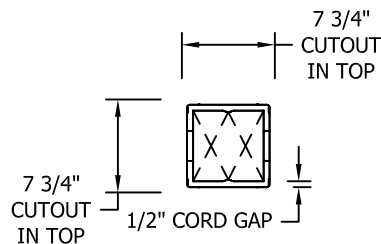

For Meeting Tables

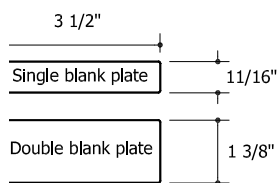
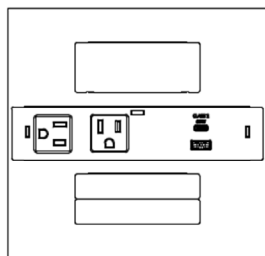
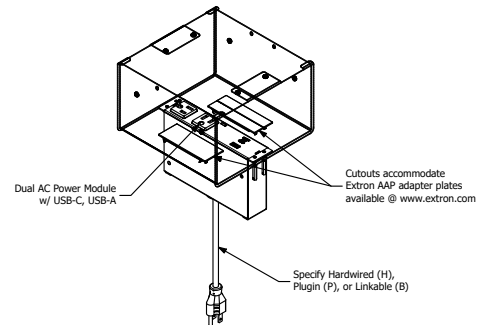
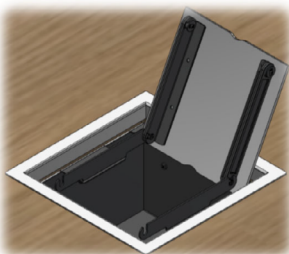

Double-Sided Meeting Table Topmount

- Provided with:
  - (1) Dual AC power module w/ USB-C, USB-A - specify hardwired (H), plugin (P), or linkable (B),
  - (2) single and (1) double space blank plates
- For additional connectivity, replace single and double space blanks with single or double space AAP plates as desired.
- Designed to accommodate Extron Series 2 retractors.
- For more information contact customer service.

Power & Connectivity  
Dual Flip Table Top  
For All Conference Tables

Pattern No.	Description	LIST
T2CH	Table Top Metal/Wood Lid Hardwire QTY 1	\$4,019
T2CP	Table Top Metal/Wood Lid Plug In QTY 1	\$4,019
T2CA	Table Top Metal/Wood Lid Linkable Hardwire QTY 1	\$4,019
T2CB	Table Top Metal/Wood Lid Linkable Plug In QTY 1	\$4,019

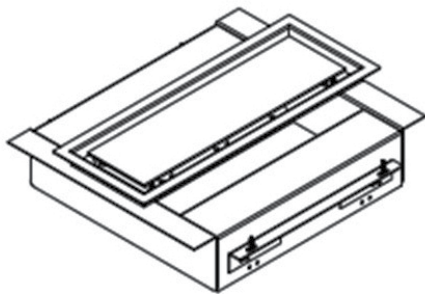

DOUBLE-HINGED TOPMOUNT

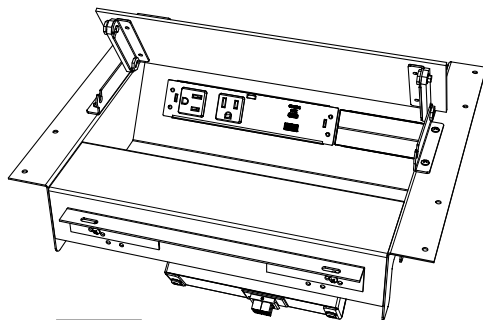
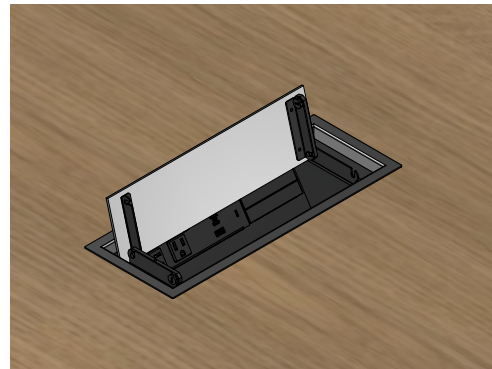

Shown without trim liner

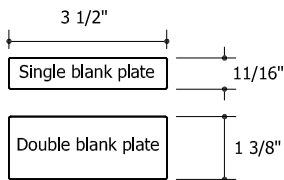

- Provided with:
  - (2) Dual AC power modules w/ USB-C, USB-A - specify hardwired (H), plugin (P), or linkable (B),
  - (4) single space blank plates
- For additional connectivity, replace single and double space blanks with single or double space AAP plates as desired.
- For more information contact customer service.

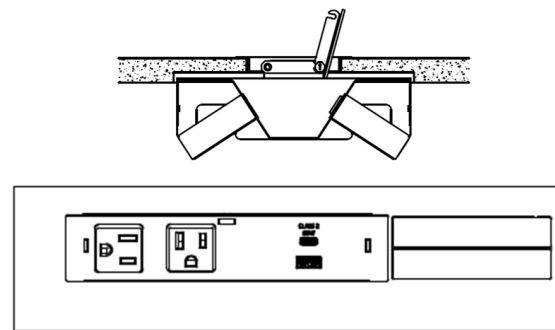

Double-Sided Conference Table Topmount  
(Both Sides)

Double-sided table top access with metal trim liner

Double-sided table top access with wood lid and no metal trim liner

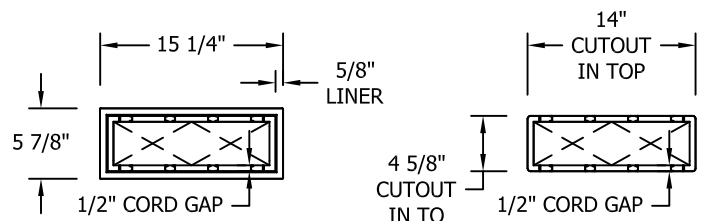

## Wire Management Column

Necessary on all HL Conference tables

### Grommet and Microphone Holes

#### Wire Management Column

Pattern No.	MC__	PM01/PM02	PM03
02WMC6X6	\$648	\$1,723	\$2,430
02WMC10X10	\$1,178	\$1,826	\$4,138

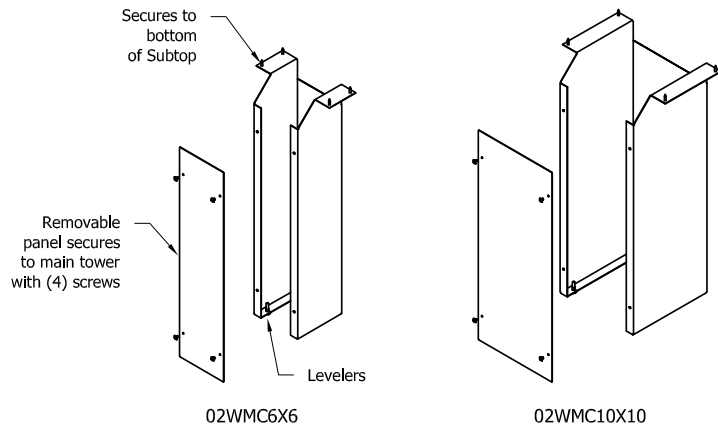

Wire Management Column  
 - Ordered separately but required with all power options for Highline Conference Tables  
 - Location is flexible but placement on table centerline is recommended

02WMC6X6 6" x 6" with clear inside of 4" x 5"  
 02WMC10X10 10" x 10" with clear inside of 8" x 9"

#### Grommet and Microphone Holes

Pattern No.	Description	LIST
MA__	Microphone Hole (factory cut)	\$401
GM__	2" Grommet (factory cut, lid, & liner)	\$528



**Note: microphone hole cutout to match customer supplied specification.**

